



narbutas

10  
year warranty

This is our promise of  
longevity and sustainability.



Scan and see  
Warranty statement

## From one computer desk to Europe's fastest-growing furniture company

Our story began in 1991. We set out on a mission to make quality and modern workspaces available to more people.

From a single product – a desk for a computer in 1991, our range grew to offer everything you need to furnish a modern office.

We produce diverse products from desks and chairs to acoustic furniture rich in technological solutions.

All of this is done in Lithuania, home to one of the largest office furniture factories in Eastern and Central Europe.

Apart from the constantly expanding production capabilities and technologies, over time our company has developed strong in-house innovation, custom-made furniture, IT, logistics, customer support departments.

All of this allows us to ensure the quality of every single step in product development.

ABOUT US	> 5
DESIGNERS	> 9
DESKS & TABLES	> 18
STORAGE	> 150
ACOUSTIC SOLUTIONS	> 188
CHAIRS	> 252
LOUNGE & SOFT FURNITURE	> 382
EXECUTIVE FURNITURE	> 436
RECEPTION FURNITURE	> 466
CUSTOM-MADE PRODUCTS	> 484
FINISHES	> 496
DEFINITION OF ICONS	> 500

# Delivering what matters

“*I also found out that, just like me, our customers like functional and good quality products and are not willing to pay for what they do not need. That is why we design and manufacture functional, high-quality, attractive yet simple things. Our design motto is: Nothing unnecessary.*”

Petras Narbutas,  
company founder and owner

## Concept & Design

---

### In-house design team

Our award-winning in-house design team comprises professionals with almost 30 years of experience in furniture production and design.

### Working with international designers

NARBUTAS experienced product development team and innovation group work closely together to find optimal, high-quality solutions. Additionally, we collaborate with internationally known designers from Lithuania, Italy, Denmark, Germany, Spain, USA, Japan, etc. Longterm work with international partners brings great results.

Find more about our work with designers on pages 9-17.

### Globally relevant

By combining Italian design, subtle Scandinavian minimalism, and natural Lithuanian coziness, we deliver design that will outlast short-lived regional fads and will be easy to integrate, expand, or combine with existing furniture and interior solutions.

### Nothing unnecessary

It matters to us that our furniture is functional, high-quality, and attractively designed, and at the same time, we make sure that our customers do not have to pay for what they do not need.

## Manufacturing

---

The continuous modernization and automation of NARBUTAS furniture factory in Lithuania ensure a reliable production process and the highest quality of furniture produced, both standard and custom-made.

### Using advanced technology

We make substantial investments in machinery and automate processes for our people to be able to focus on what really matters. Our main goal is to reduce the workload for our employees and to increase our production volume.

### Integrating lean production

We follow the lean method to be able to hedge against the risk of error even during the rapid growth of volumes. We are growing at an incredible speed: around 40% a year. The lean method has allowed us to be flexible and to eliminate all possible errors in advance. Even with this growth, we are continuing to manufacture within the 2-week window that has always been our standard.

### Assuring quality

Our quality control is executed in multiple stages to assure there are no errors in the final result. First, we check the quality of materials received from our suppliers, secondly, the components produced, finally, one more inspection of the completed components is conducted before the packaging process. While all these processes take a long time, they enable us to ensure that only high-quality products are delivered to our customers.

## Set-up & Consulting

---

We offer various solutions aimed at making the whole process, from choosing your furniture to setting it up as quick and simple as possible.

### Extensive customer support

Highly qualified NARBUTAS customer support team speaks seven languages (Lithuanian, English, French, German, Russian, Italian, Polish, Spanish). Dedicated key account managers assure timely response and work with tight client feedback loops.

### Tailored visualizations

Our team will help you make the most of your office space by suggesting a layout for your office and the furniture according to your expressed needs. We make it easier for you to imagine products in your space by creating tailored 3D visualizations.

### Online ordering system and additional services

NARBUTAS online price list contains extensive information regarding our product ranges and services including catalogues, product presentations, technical sheets, operation manuals, and pictures. All of our assembling schemes are made available on our website or can be found by scanning the QR code on the box of the product. This way we make it easier for clients to plan the assembling process and time in advance. We provide videos explaining the more difficult parts of assembling. For your convenience also provide full support in logistical arrangements.

## Custom-made solutions

---

There is no office culture that works in the same way, there is no team that has the same needs. This is why we specialize in custom-made office furniture that attends to individual needs.

### Flexibility & professionalism

Experienced team of professionals can adapt the size or materials of our current standard products to suit your office requirements or create new ones. Engineers of Non-standard Furniture Department will consider every last detail to suggest the best solution and bring your vision to life. All ideas turn into functional and ergonomic office furniture.

### Technical capacity

Our state-of-the-art equipment is highly universal and allowing us to manufacture both large and small individual orders. It makes us very flexible when it comes to customer requests and the capability of realizing even the most complex projects. We have mastered the use of diverse materials, creating furniture with bentwood or metal elements of varying complexity, as well as upholstered and acoustic furniture.

Find more about the custom-made solutions we offer our customers on pages 484-495.

# Christina Strand and Niels Hvass



“ We met the NARBUTAS team and felt that the company’s strategy fitted into our way of working. We developed a good relationship and met great enthusiastic people who want to move the company forward.

Strand + Hvass have many years of experience in the world of design. Over the years, their style has developed to become modern and innovative, yet based on classic values and a timeless aesthetic. They have a bold vision of the value and impact of design on today’s world and create unique products to match.



**TWIST&SIT**

> 344  
VISITOR,  
CONFERENCE &  
DINING CHAIRS



**TWIST&SIT Soft**

> 392  
SOFAS  
> 416  
LOUNGE  
CHAIRS



**SOFT ROCK**

> 410  
LOUNGE CHAIRS AND  
MODULAR SYSTEMS



**JAZZ Silent Box**

> 238  
ACOUSTIC  
FURNITURE



**JAZZ Chill Out**

> 430  
MODULAR SYSTEMS  
AND POUFS

# Baldanzi & Novelli Designers



“  
The extraordinary thing I have discovered in Lithuania is the desire to create things. While working together hand in hand our two cultures mix and complement each other resulting in a third element – an energy that cannot be found elsewhere.

Collaboration of Baldanzi & Novelli designers and NARBUTAS began in 2013 with mutual interest. NARBUTAS were interested in Baldanzi & Novelli's more than 30 years of experience, great design culture, originality, and familiarity with cutting-edge technology, while the designers were attracted to the company's clear-cut vision and recognizable style.

# Paolo Pampanoni



“  
I want to discover new forms and bring more colors to a modern office.

Paolo Pampanoni is an Umbria-based architect specializing in architecture for work and design. His leading principle is the “performance principle”: every aspect of the design of space or products must lead to a formal, functional, technical, or economic performance.



D-CHAIR

> 256 TASK CHAIRS  
> 304 EXECUTIVE CHAIRS  
> 328 VISITOR, CONFERENCE & DINING CHAIRS



WIND

> 278 TASK CHAIRS  
> 302 HIGH SWIVEL CHAIRS  
> 340 VISITOR, CONFERENCE & DINING CHAIRS



WORKLAB

> 120 DESKS  
> 120 CONFERENCE WALLS  
> 120 STORAGE



SANDIE

> 268 TASK CHAIRS  
> 314 EXECUTIVE CHAIRS  
> 336 VISITOR, CONFERENCE & DINING CHAIRS  
> 406 LOUNGE CHAIRS



NORTH CAPE

> 284 TASK CHAIRS  
> 318 EXECUTIVE CHAIRS  
> 346 VISITOR, CONFERENCE & DINING CHAIRS



ARCIPELAGO

> 396 SOFAS, LOUNGE CHAIRS, MODULAR SYSTEMS AND POUFS



ARCIPELAGO Wood

> 248 ACOUSTIC FURNITURE



ZEDO

> 46 DESKS  
> 100 CONFERENCE & MEETING TABLES



ZEDO PET

> 222 ACOUSTIC DESK SCREEN

PLANA

> 108 CONFERENCE & MEETING TABLES  
> 458 EXECUTIVE FURNITURE

# Orlandini Design



“ I don't think we need new objects unless they have something new to say. When I design a new piece of furniture, such as a chair or a desk, it has to add something different to my life. A new charming shape, a new way of working, a new technical solution, a new material.

Folco Orlandini was born in 1972 in the Italian city of Grosseto. He studied architecture at the Polytechnic University of Milan before gaining work experience in various design studios. Since 2009, together with his father Paolo, he has been running the legendary Orlandini Design studio founded by his father in the 1960s.



ARQUS

> 92

CONFERENCE & MEETING TABLES

> 438

EXECUTIVE FURNITURE



POLYTONE-0

> 350

VISITOR, CONFERENCE & DINING CHAIRS

# Roberto Lucci

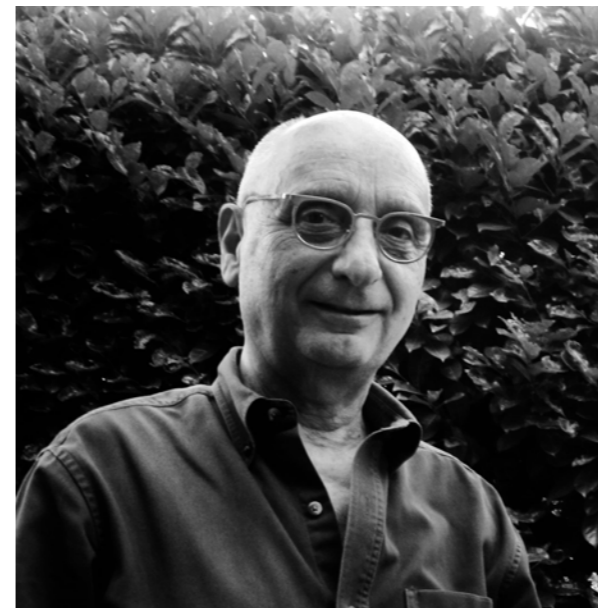

“ Creativity alone is not design and problem solving without creativity is not design either.

Roberto Lucci has been designing for over half a century, always driven by the notion that design is creative problem-solving.



PLANA

> 108

CONFERENCE & MEETING TABLES

> 458

EXECUTIVE FURNITURE

# Alegre Design



“ We believe that the future of design lies in combining creativity and precision. With NARBUTAS, we fuse aesthetics and cutting-edge technology to configure workspaces that are as functional as they are inspiring.

The creative philosophy of the studio Alegre Design is to inspire change through innovations and design, think and create not only what is expected today but also anticipate what people will need in the nearest future. This studio understands design as a global concept that encompasses more than just style, it has the potential to create realistic solutions for the product’s lifespan: from the production process itself, the sustainability of its manufacturing, the use efficiency, the user interface or its environmentally-friendly materials.



## OFY

- > 262 TASK CHAIRS
- > 308 EXECUTIVE CHAIRS
- > 332 VISITOR, CONFERENCE & DINING CHAIRS

# Annie Lee



“ We often forget that design is a powerful language – it needs clear communication. Design is a special moment, whether for an individual or a big brand, to convey their message from the inside out. And what is on the inside always matters.

Annie Lee was born and raised in South Korea before moving to the U.S. to study and work in fashion. A shift in fate found her a successful career blazing a trail through New York City’s interior design industry for 20+ years. Today, Annie is the design leader of ENV and former IIDA NY President.



## ZooZoo

- > 96 CONFERENCE & MEETING TABLES
- > 140 OCCASIONAL TABLES
- > 432 POUFS

# MUCNYC



“ From day one, we felt the synergy with NARBUTAS. The authenticity, passion, and dedication of the NARBUTAS people drive innovation and embody the brand’s values in every detail. This is more than a partnership; it’s the fusion of our cultures and a shared vision for the future of workplace design.

Stefanie Kubanek and Michael Geldmacher—a dynamic design duo bridging Munich and New York—blend global expertise with creative mastery to craft thoughtful, impactful solutions across products, systems, and experiences.



## MYAMI

> 386 SOFAS  
> 402 LOUNGE CHAIRS

# Gediminas Juška



“ I associate Narbutas with professionalism, solidity, and consistency. The company’s products stand for high quality and a modern, elegant design.

Gediminas Juška began working with NARBUTAS in 2000, soon after completing his architecture degree at the Vilnius Academy of Arts. Since then his creations for the company have won the Grand Prix at the Furniture 2001 Fair, the Main Prize of Good Design 2012, and other prizes at national and international events. Juška has always specialized in office furniture and interiors, and his achievements have earned him recognition in Lithuania and beyond.



## MOVE&LEAD

> 446 EXECUTIVE FURNITURE



## AIR

> 76 DESKS  
> 114 CONFERENCE & MEETING TABLES  
> 462 EXECUTIVE FURNITURE

# DESKS & TABLES

## SIT-STAND DESKS



Q-ACTIVE  
> 24



EASY  
> 42



B-ACTIVE  
> 30



ACTIVE  
> 34



MOTION  
> 36

## DESKS



ZEDO  
> 46



T-EASY  
> 80



ROUND  
> 54



OPTIMA C  
> 82



NOVA Wood  
> 64



OPTIMA Plus  
> 83



NOVA  
> 70



WORKLAB  
> 120



AIR  
> 76

# CONFERENCE & MEETING TABLES



**ROUND Multipurpose**  
> 84



**ZEDO**  
> 100



**NOVA**  
> 112



**FOLDING**  
> 116



**PARTHOS**  
> 88



**NOVA Wood**  
> 102



**AIR**  
> 114



**FORUM**  
> 118

20



**ARQUS**  
> 92



**NOVA Wood Multipurpose**  
> 106



**FLIP-TOP**  
> 116



**OPTIMA**  
> 119

21



**ZooZoo**  
> 96



**PLANA**  
> 108



**FLIP-TOP.II**  
> 116



**T-EASY**  
> 119

# CONFERENCE WALLS



**WORKLAB**  
> 120



**MEDIA**  
> 124



**COMBUS**  
> 152

# HIGH TABLES



**ROUND Multipurpose**  
> 126



**PARTHOS**  
> 132



**NOVA Wood Multipurpose**  
> 134



**NOVA Wood**  
> 136



**NOVA**  
> 138



**LIGHT**  
> 138

# OCCASIONAL TABLES



**ZooZoo**  
> 140



**PARTHOS**  
> 144



**NOVA Wood**  
> 146



**NOVA**  
> 146



**FORUM**  
> 146



**OPTIMA**  
> 147



**AMBER**  
> 147



**MOBI**  
> 147

# Q-ACTIVE

Ergonomic  
workplace in  
just 9 minutes

A workplace with a sit-stand desk is versatile and easily adapts to different working styles and changing tasks. Thus, we invite you to discover Q-ACTIVE. It is a modern sit-stand desk that makes it quick and easy to set up an ergonomic workplace.

24

↑  
MAX  
1292 mm  
MIN  
642 mm  
↓



25



\* - only 800  
\*\* - left/right

## Optimised smart packaging

The Q-ACTIVE sit-stand desk is delivered pre-assembled, with the entire frame in one package and your chosen desktop in the other. The smart packaging design ensures smoother and faster product assembly.



26

Very quick assembly – an advantage for large projects

The structure of the Q-ACTIVE desk was developed in such a way that the desk can be assembled as quickly as possible, allowing you to set up your office workplaces in the shortest possible time. The whole Q-ACTIVE desk can be assembled in just 9 minutes.



## Wide range of applications for different spaces

With a range of desktop sizes and colours, as well as a telescopic frame that fits all desktops, you can create desks of your desired design that are easily adaptable to different office spaces.

27

## Achieve your level of comfort

The height of the desk can be adjusted with the button of your choice – with a screen or up/down version. You can choose the most comfortable desk height for you and save your two preferred positions.

The sensor in the desk legs reacts to obstacles by automatically stopping the desktop. The anti-collision feature reduces the likelihood of damage should the desk collide with a hard object.

SIT-STAND  
DESKS

PET felt  
BA02

CYBER  
GB10

RUNNER mesh  
FR04

AUSTEA  
GT04

STEP  
GL15

# B-ACTIVE

Enjoy more freedom,  
physical activity and  
productivity!

B-ACTIVE is a practical electric height-adjustable  
desk that stands for ergonomics and quality,  
which is now even more accessible to customers.



## Every detail matters

You can choose from two different types of metal legs.  
Create your own custom B-ACTIVE desk by choosing  
desired components from the desktop right down to  
the feet.



## Safety and stability

For greater safety at the workplace, B-ACTIVE has  
an integrated anti-collision feature and a feature  
protecting the desk against overloading.

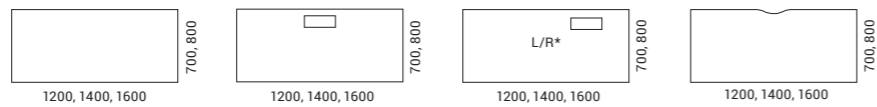

SIT-STAND  
DESKS

SIT-STAND  
DESKS



RUNNER mesh  
FR03

STEP Melange  
GL12

B-ACTIVE

B-ACTIVE

# ACTIVE

An easy way to stay active at work!

ACTIVE desking system can be best described in two words: functionality and quality.

## Easy to customize

The desk height can be adjusted by pressing a selected button: a memory position button with a display, or up and down controls.



34

35

## Feet design

Choose from three types of metal feet. All the designs look minimalist, light and with different elegant accents.



## Anti-collision feature

Both the 2-level and 3-level feet sensor will automatically stop the desk's movement if it senses an obstacle in its path. The anti-collision feature reduces the likelihood of damage should the desk collide with a hard object.

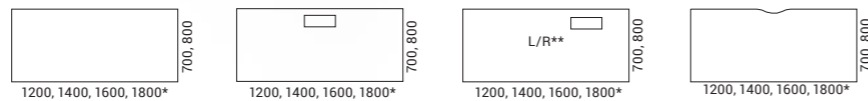

\* - only 800  
\*\* - left/right

SIT-STAND  
DESKS

# MOTION

> 452  
EXECUTIVE  
FURNITURE

SIT-STAND  
DESKS

Makes you move  
forward!

The system is available as single desks  
or bench desks designed for a flexible  
arrangement of workstations as well  
as for individual or group work.



↑  
MAX  
1200 / 1300 mm  
  
MIN  
650 / 700 mm  
↓

36

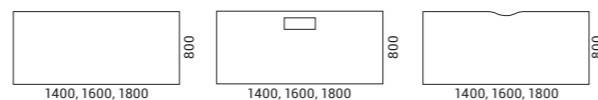

MOTION

INTERIA DISTRIBUTED BY  
PT INTERIA REGALIA NUSANTARA  
hello@by-interia.com



## Acoustics and concentration

A fixed-height acoustic desk screen MODUS designed for bench desks will ensure acoustic comfort and help your employees maintain concentration. Furthermore, the double-sided acoustic desk screens allow you to create colourful combinations.



## Leg design

MOTION desks offer a choice of two different leg designs. H-shaped metal legs provide a more generous space for movement and storage. Those who desire more privacy can choose a desk with panel legs which visually cover up the space under the desk and add an aesthetic look to it.

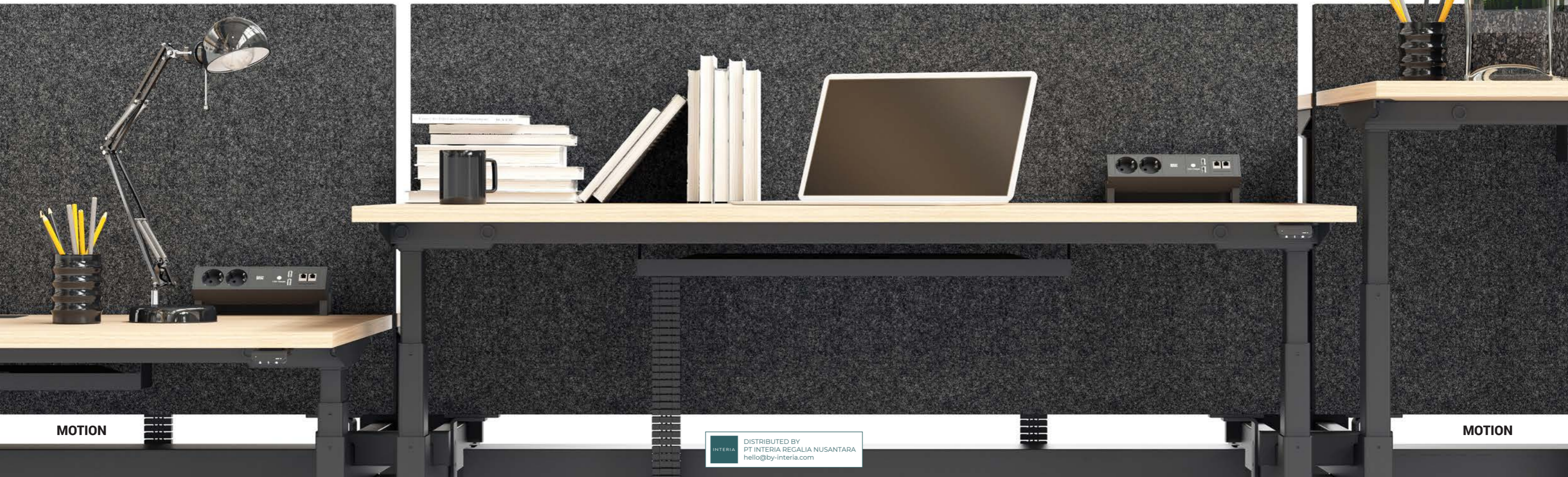
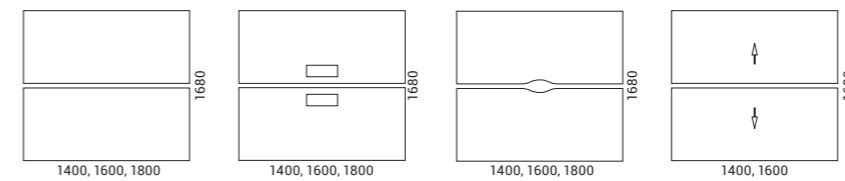

SIT-STAND  
DESKS

SYNERGY  
GS48

SYNERGY  
GS32

MOTION

INTERIA DISTRIBUTED BY  
PT INTERIA REGALIA NUSANTARA  
hello@by-interia.com

Makes it easy to  
be productive!

Easy to choose, easy to use, and easy to  
stay productive for a longer period of time.



## Stability

Two-desk benches are an excellent solution  
for combining workstations. The shared leg  
of the sit-stand desks provide maximum  
stability of the joined desks.

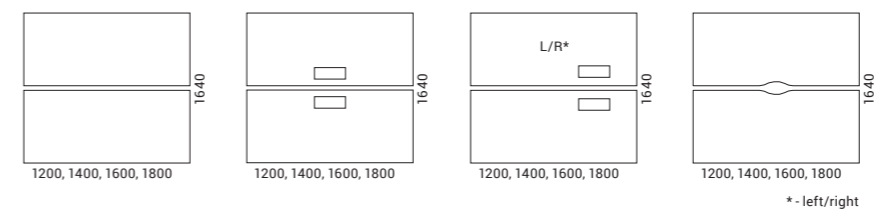
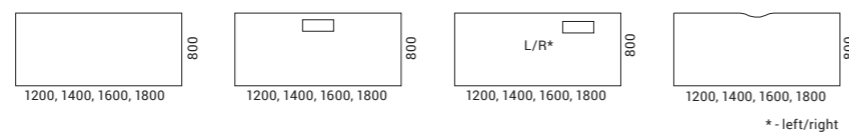

44

XTREME Plus  
GY02

45

EASY

EASY

# ZEDO

Design by Paolo Pampanoni

> 100  
CONFERENCE  
& MEETING  
TABLES

Workplace  
that inspires

A work environment with an original character makes employees more engaged and helps them to build and maintain a closer relationship with a company. ZEDO is an inspiring and flexible desk system featuring distinctive design with carefully selected and colourful accessories that will help you create workplaces with a unique character.

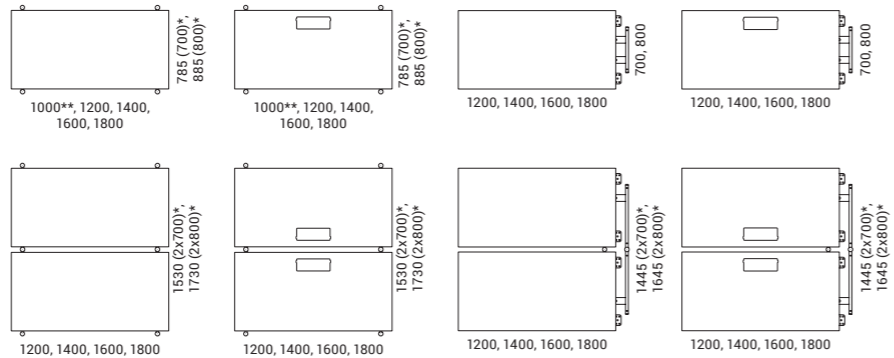

\* - desktop depth  
\*\* - only 785 (700)

Original design and  
unique combinations

The main element of the ZEDO design is a round metal leg on the outer part of the table, with a playful coloured plug as the final touch. The original design of the desks offers a very wide range of options for combining the colours of legs, plugs and accessories to create a unique workplace atmosphere.



DESKS

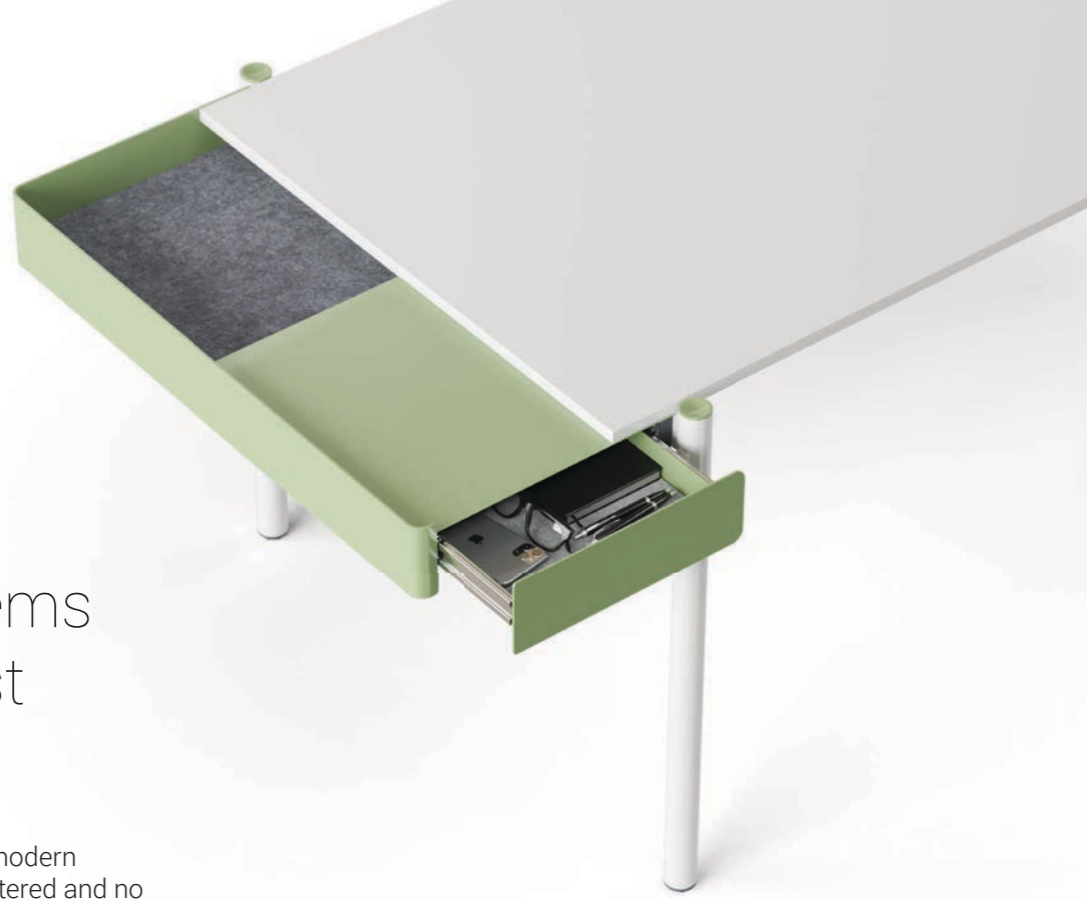

For storing items in a minimalist workplace

Thanks to digital technology, a modern workplace is becoming less cluttered and no longer requires many cabinets. Minimalist drawers and open niches with a PET felt lining are perfect for such a case.

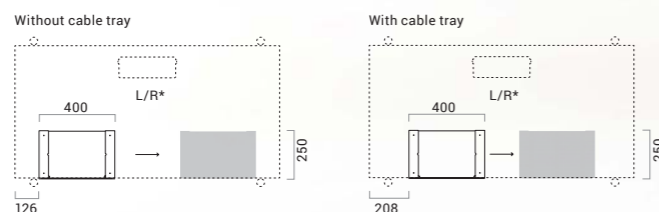
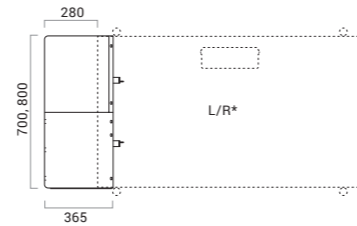

\* - left/right

DESKS

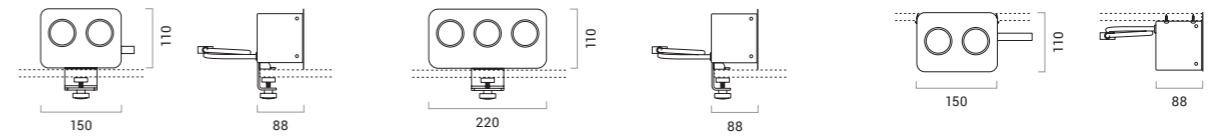

Design continuation in convenient power solutions

Exceptional power units blend in the whole design concept perfectly due to the choice of metal colour and rounded forms. The power unit can be mounted on or under the desk for convenient and quick access to electricity.

Thought out to the smallest detail

A wide range of pedestals and storage towers allow you to store your personal items conveniently as well as hide cables. The holes in the frames allow you to easily combine several workspaces into a single power circuit, while the elegant metal box with opening grommet provides easy access to the sockets.



Cable-hiding desk screen construction



Pedestals for convenient item storage



Cut-out for wire management

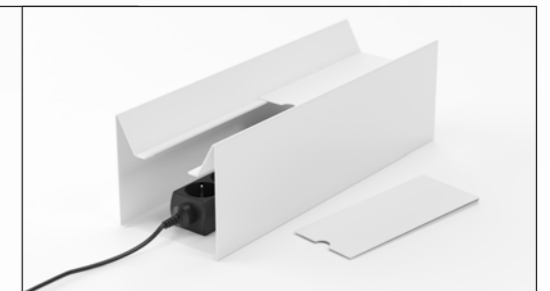

Metal box for power unit and cable management



A niche for storing items

50

51

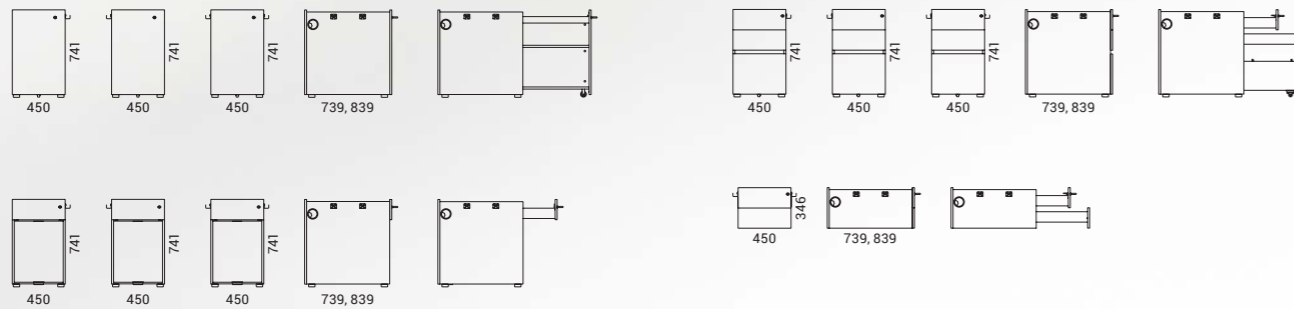

# Colourful shelves – stylish and practical

Bicoloured metal shelves create a distinctive and stylish look. Shelves of varying forms can be combined with each other and into higher compositions. That way you will also clear your desk of small items and be able to clean it easily as well as disinfect.

52

53

## An easily adaptable return table

Extend your desk possibilities with a rotatable return table that can be used for both temporary work while standing and short meetings due to its larger height.

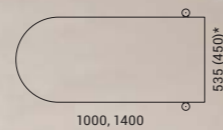

\* - desktop depth

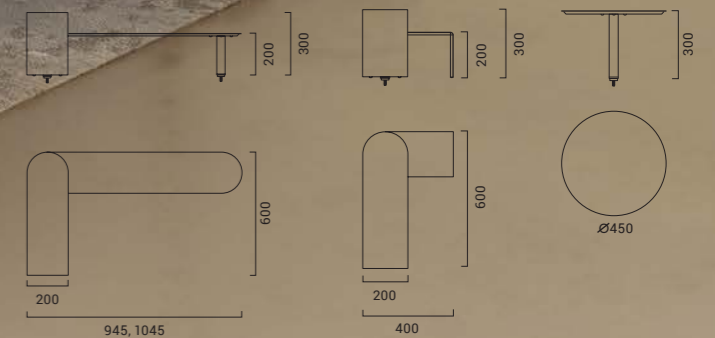

# ROUND

For effective workplace design

Use the office space effectively with a ROUND system which combines office desks, cabinets and screens. Creating open and private workplaces for your team was never as easy.



54

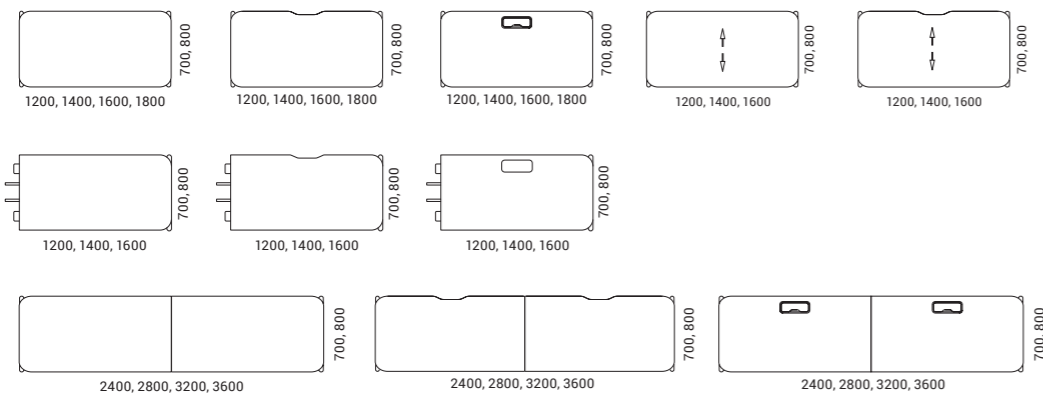

\* Desktops are also available with square corners.



RUNNER mesh  
FR04

STEP  
GL15

From single desk to bench desks for collaborative tasks

56



57

Create workplaces based on the number of employees and the nature of the tasks performed ranging from single desks to bench desks. The latter are very popular as they enable both small and large teams to create a workspace ideally suited for collaborative tasks.

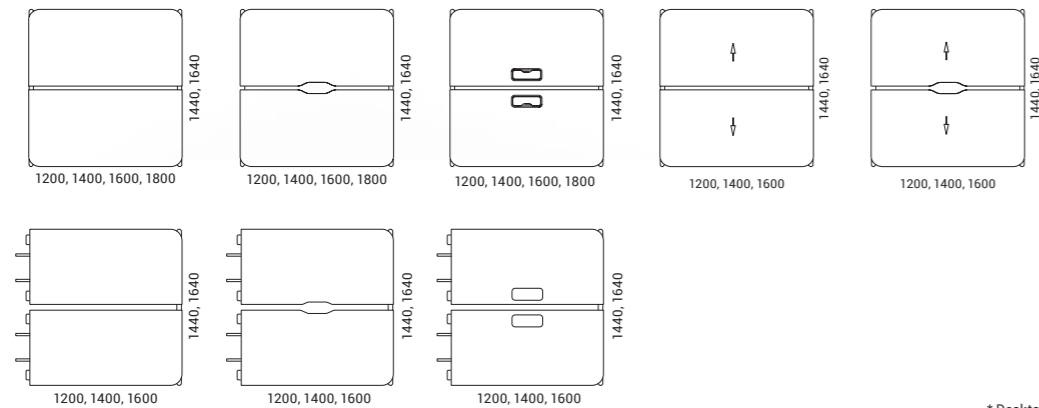

\* Desktops are also available with square corners.

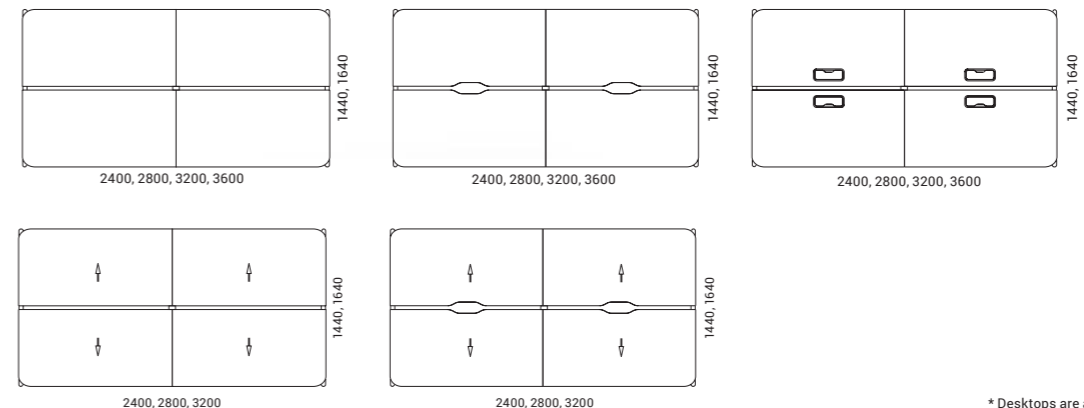

\* Desktops are also available with square corners.

# Modular cabinet system

Desk height cabinets can be made higher with additional shelving units and which can be single-sided or double-sided and open or closed.

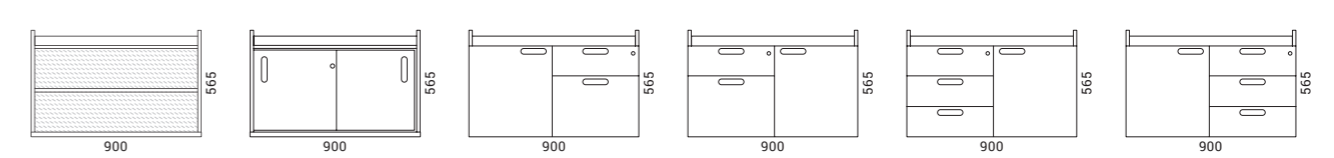
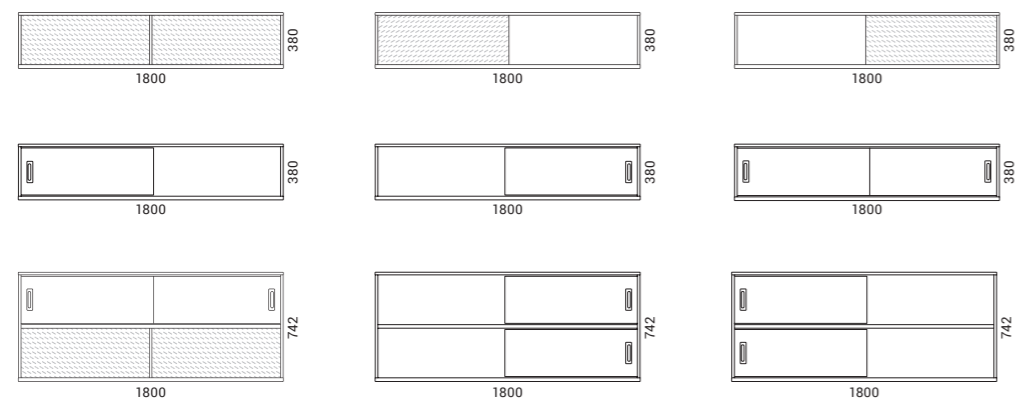

## DESKS

Power management solutions with wide range of applications



60

The ROUND desk system allows for easy connection of several workplaces into a single electrical circuit. Cabinets serve an important function in power supply and data transmission as they come with a grommet for wire and cable management.

ROUND



ROUND



PET felt  
BA10

AUSTEA  
GT07

DESKS

# NOVA Wood

> 102  
> 106  
CONFERENCE  
& MEETING  
TABLES

> 134  
> 136  
HIGH  
TABLES

> 146  
OCCASIONAL  
TABLES

A touch of nature  
in your office!

NOVA Wood is a desking system that adds a delicate sense of luxury to your office and brings you closer to nature and home atmosphere!

64

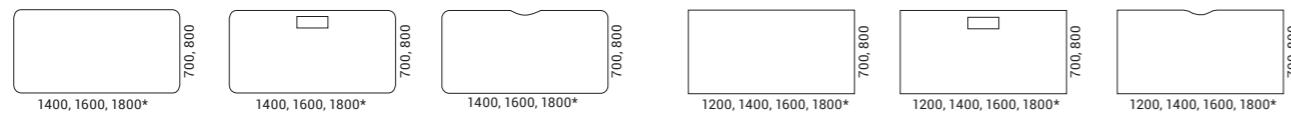

\* - only 800

NOVA Wood

INTERIA DISTRIBUTED BY  
PT INTERIA REGALIA NUSANTARA  
hello@by-interia.com



AUSTEA  
GT04

AUSTEA  
GT02

VALENCIA  
DV02

NOVA Wood

# Every table is unique

Wood texture and wide growth rings create a distinctive pattern. Stained and lacquered wood reveals the pattern even more. Natural wood tends to change its colour over time.



66

You can adapt bench desks consisting of two desks to your office dynamics by using supplementary partitions which allow you to easily increase the number of workplaces.



67

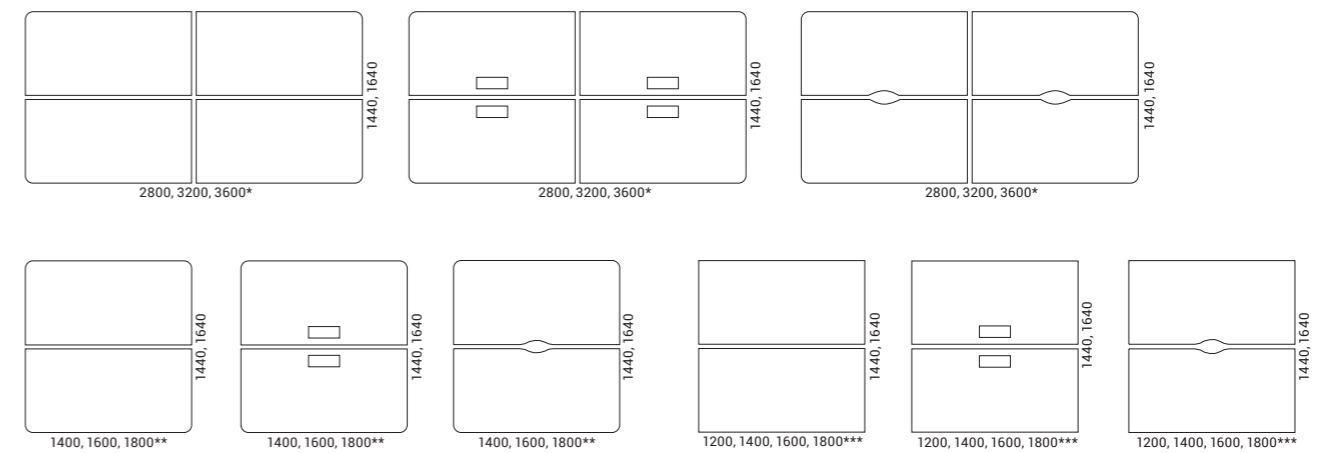

\* - only 1640  
 \*\* - only 800, 1640  
 \*\*\* - only 800



AUSTEA  
GT07

CYBER  
GB11

# NOVA

- > 112  
CONFERENCE  
& MEETING  
TABLES
- > 138  
HIGH  
TABLES
- > 146  
OCCASIONAL  
TABLES

## Modern classic

Even the name itself derived from the Latin word meaning something "new". If you change the desktop texture or leg colour, you will be able to create a whole new desk.

70



NOVA

## U

Regular U-shaped legs is a universal design solution.



## A

A-shaped legs are sure to add subtle look and elegance to NOVA A desks.



## O

O-shape desk legs are unique in that you can additionally order a special divider designed for two-seat and four-seat desks.



## H

Height adjustable feet allow you to easily change the desk height from 620 mm to 850 mm.



71

NOVA

# Sliding desktop

Choose functional NOVA U Slide desks with a push/pull desktop. The arrangement of the cable duct, the access to the power unit and cable management will be much more convenient. These desks are based on a very simple principle: to access the cable duct, pull the desktop toward yourself; if you want to conceal the cables, then simply push the desktop slightly.

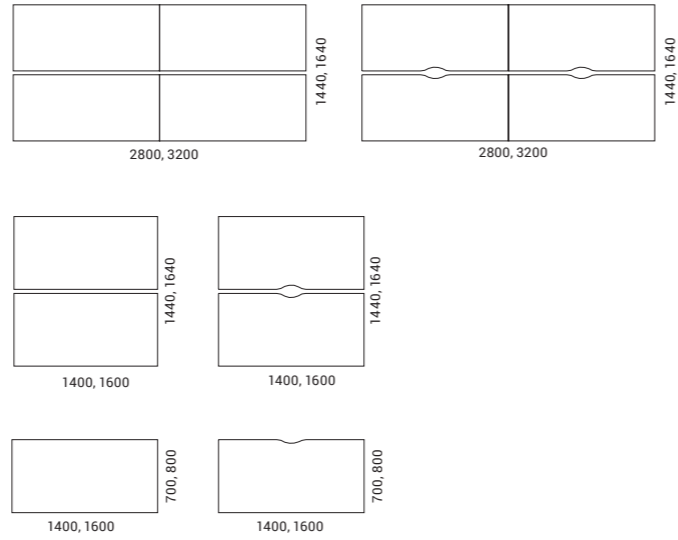

# Clover-shaped teamwork desk

Bench desk with cut-outs for wire management has a clover-like shape. Ideal for setting up a work-space for a team of three people.

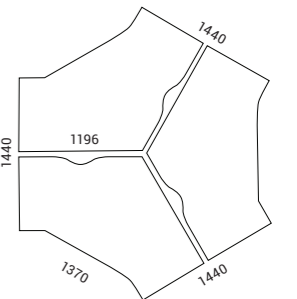
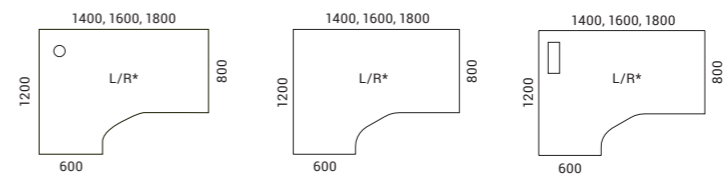

# DESKS

You can adapt bench desks consisting of two desks to your office dynamics by using supplementary partitions which allow you to easily increase the number of workplace.



74

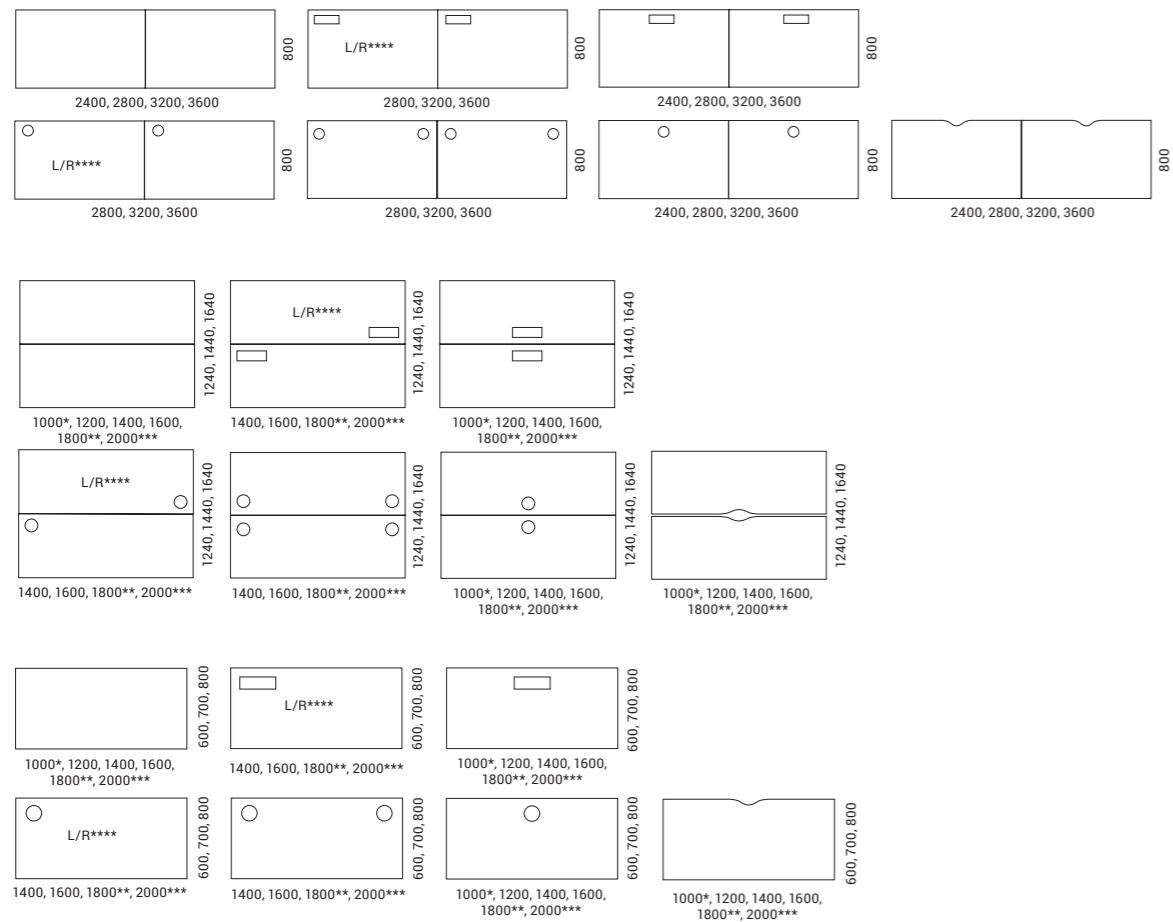

NOVA

\* - only 600  
 \*\* - 700 and 800  
 \*\*\* - only 800  
 \*\*\*\* - left/right



75

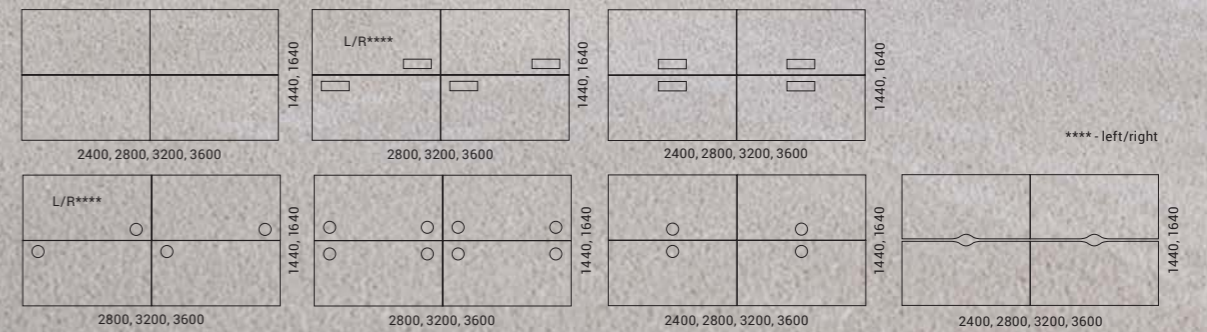

NOVA

# AIR

Design by Gediminas Juška

Furniture that appears as if floating in thin air

An exceptional feature of AIR desks is thin metal legs that convey a sense of lightness and at the same time ensure their durability and stability.



76

> 114  
CONFERENCE  
& MEETING  
TABLES

> 462  
EXECUTIVE  
FURNITURE

To make even more efficient use of space, choose a cabinet suspended at hand's reach above the desk for storing personal items and office supplies.



77

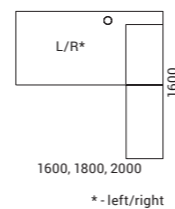
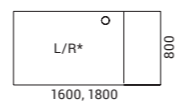
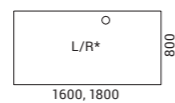
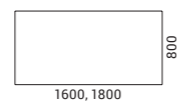
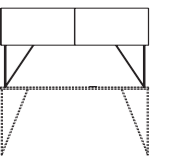

\* - left/right

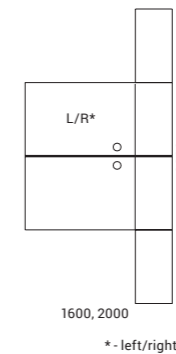
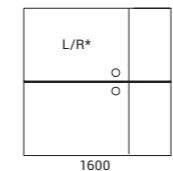
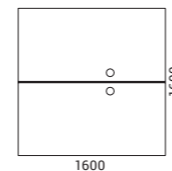

\* - left/right

Minimalist AIR designs, thought through solutions, combinations of different textures and colours – all this provides more creative freedom for architects who design office spaces.

DESKS

DESKS

“

*I think that a modern workspace should be functional and light just like pristine nature, crystal-clear water and fresh AIR.*

Gediminas Juška



AIR

AIR

# T-EASY

> 119  
 CONFERENCE  
 & MEETING  
 TABLES

Desks that do not restrict the user's freedom of movement

T-EASY desks are ideal for the office workspace design combines fixed-height desks (H=740 mm) for shorter working periods, and ergonomic electric adjustable desks for regular work which allow the users to change their posture using the sit-stand principle.

80

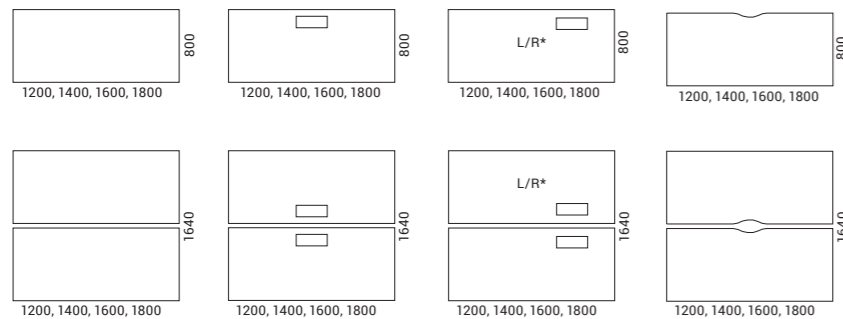

\* - left/right

T-EASY



T-EASY

# OPTIMA C

An optimal solution for your workplace

> 83  
DESKS

> 119  
CONFERENCE & MEETING TABLES

> 147  
OCCASIONAL TABLES

82



It allows you to create a comfortable, functional and well-organized work environment using minimum components. The desk has C-shape double cantilever legs and an insert for discreet management of wires and cables. Choose the type of desktop that meets your needs best.

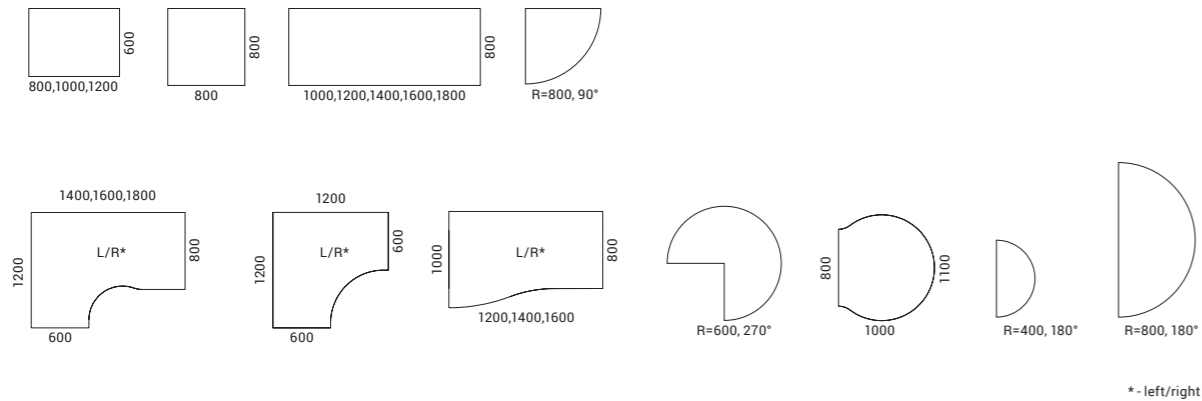

OPTIMA C

# OPTIMA Plus

> 82  
DESKS

> 119  
CONFERENCE & MEETING TABLES

> 147  
OCCASIONAL TABLES

83



The system includes panel end legs with levelling feet which provides stability on uneven flooring. Choose the type of desktop that meets your needs best: a rectangular desktop, a desktop with left- or right-handed configurations, a corner desktop or a wave desktop.

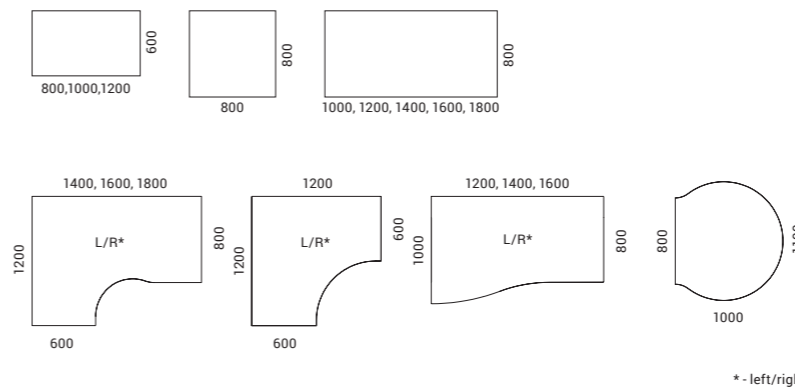

OPTIMA Plus

# ROUND

## Multipurpose

Designed for every  
work scenario

A system of tables designed for all types of meetings, team or individual work and provides mobility. These tables were created with the aim of meeting the need for flexible office furniture suitable for various situations. The collection consists of tables in three heights and two tabletop depths.



reddot winner 2025



84

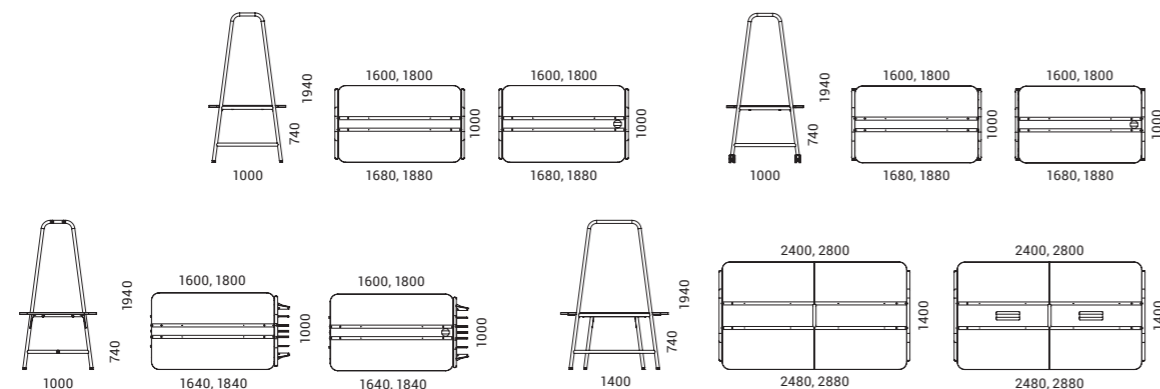

Light  
industrial  
design

The design of the table blends the usual features of a strict industrial design with a soft contemporary aesthetic. It combines the usual characteristics of strict industrial design with soft contemporary aesthetics. This style embraces the raw beauty of industrial materials, such as metal, while prioritising practicality and wide applicability.

## CONFERENCE & MEETING TABLES

### Create the look you want

The selected planter boxes will add style to your office space, creating a trendy biophilic interior. The perforated metal top and the decorations hanging from it will bring more coziness and individuality to the workspaces.



### A table that grows with the team

As the team expands, the demand for new employee spaces increases. For this, the tables with 1000 mm deep tabletops can be extended using supplementary units.

### For effective collaboration

A monitor attached to the table legs will ensure that meetings run smoothly and engage all participants. Opting for a whiteboard will provide a convenient way to manage key information.

**ROUND Multipurpose**

## CONFERENCE & MEETING TABLES

Collaboration will be facilitated by convenient shelves attached to the table legs, providing storage for essentials needed for meetings and individual tasks. The attachable hook is ideal for hanging your bag.



**ROUND Multipurpose**

> 132

HIGH  
TABLES

> 144

OCCASIONAL  
TABLES



88

## Architectural design

The main design element of the table is a sculptural cylindrical column resembling classical architecture. It is the unifying and distinctive design element of the PARTHOS table collection. Round tables are ideal for effective collaboration, because we can see and hear each other well and actively share ideas and information.

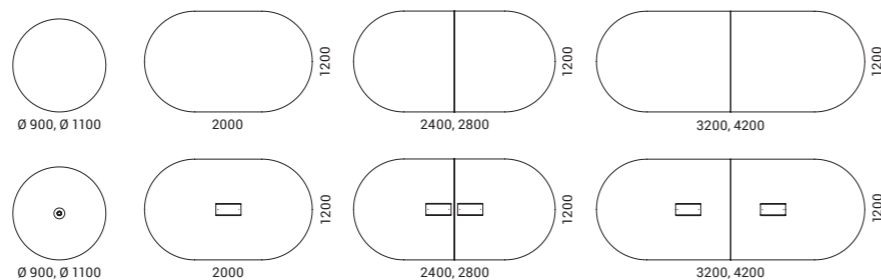

## Thoughtful functional solutions

You will not see any protruding cables on the PARTHOS tables, as they are hidden under the tabletop in a PET felt cable tray and column. For two and three column meeting tables, you can also choose a rectangular metal table grommet for wire management.



89

## Developed according to the sustainability principles

The tables are made from recyclable materials using energy from renewable sources. The furniture is durable and its design is well thought out. The tables that are no longer in use can be easily disassembled and their parts can then be recycled.

**CONFERENCE  
& MEETING  
TABLES**

Design with  
elegant shapes

The cylindrical column is covered with PET felt, whose textural pattern of vertical lines further emphasises the allusion to the element of classical architecture.



**PARTHOS**

INTERIA  
DISTRIBUTED BY  
PT INTERIA REGALIA NUSANTARA  
hello@by-interia.com

# ARQUS

Designer Orlandini Design

> 438  
EXECUTIVE  
FURNITURE

Modern luxury  
with character

Executive furniture collection with a modern luxury feel. Every piece of this furniture emphasises a flawless image and distinctive character.



92

Unique shapes  
of meeting  
tables

Meeting tables are available with two types of tabletops – rectangular and boat-shaped. The latter shape facilitates communication and collaboration among meeting participants, allows everyone seated around the table to have clear sightlines and encourages eye contact.

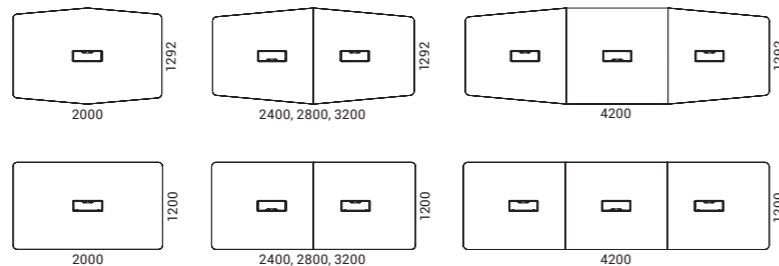

Modern luxury  
design

The sturdy structure of metal table legs is a distinctive design element that adds the piece of furniture a sense of lightness as well as longevity and durability. The collection is made from the highest quality materials. They symbolise luxury and refinement.



93

## Fully complete presentable image

By using the entire ARQUS collection for the interior, you can set up an exceptionally modern and presentable executive workspace that not only has an elegant style but also creates a very comfortable working environment.

AUSTEA  
GT02

Designer Annie Lee

> 140  
OCCASIONAL  
TABLES

> 432  
POUFS

## Make room for one more idea

Because of their low height, regular coffee tables are less convenient when used in meeting settings. Nevertheless, informal work meetings and discussions often happen in lounge areas. This poses a problem that the interior designer Annie Lee decided to solve by creating ZooZoo, a coffee table with an atypical height of 69 cm.



96



## Modern design

The ZooZoo collection was designed with inviting and friendly curvilinear shapes paired with light and clean lines of metal verticals. The knife edge tabletop brings out sleek and airy feel while the soft shape of the pouf maintains a welcoming atmosphere.

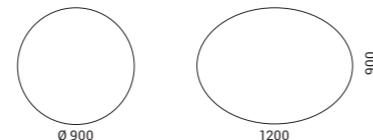

ZooZoo

INTERIA  
DISTRIBUTED BY  
PT INTERIA REGALIA NUSANTARA  
hello@by-interia.com

97



## Multitude of possible combinations

The wide choice of finishes and colours available will enable you to create the desired aesthetic that will align seamlessly with your interior design concept.

ZooZoo



AUSTEA  
GT08

SYNERGY  
GS32

Design by Paolo Pampanoni

For an inspiring  
workplace for  
meetings

Due to the original design, the ZEDO meeting table can be in a regular shape or, using a supplementary unit and shelves, transform into a unique combination.



100

Two forms

ZEDO meeting tables are available with square or rounded edges. Depending on the chosen desk size, four to six people can comfortably collaborate at a desk.

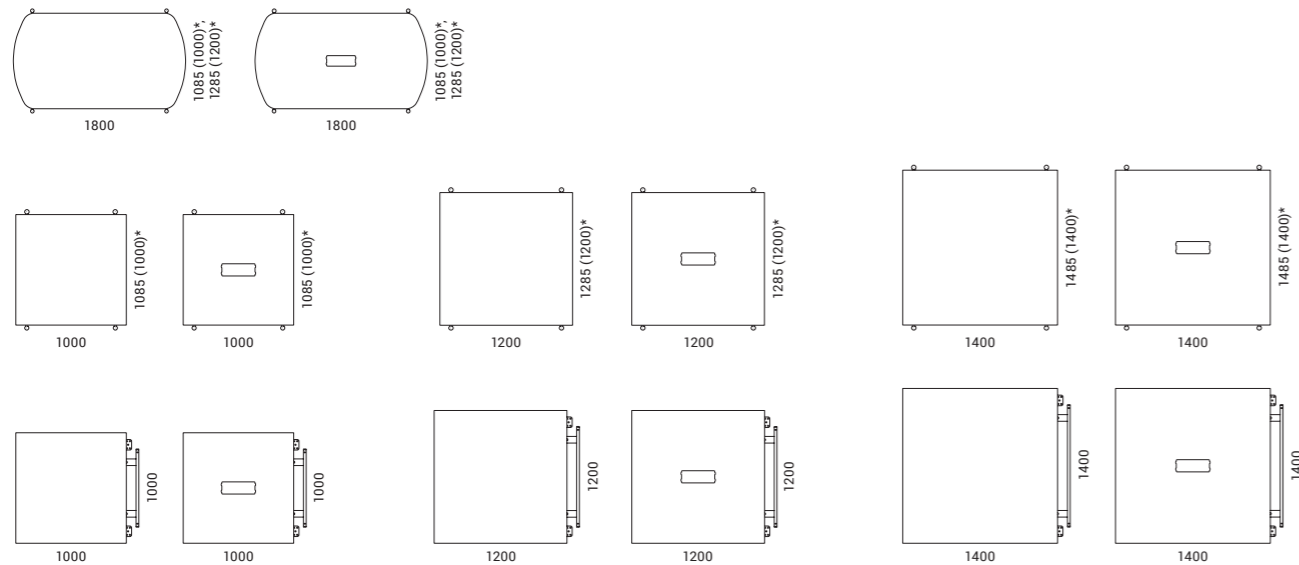

\* - tabletop depth

ZEDO

Flexible adjustability

Flexibility is an integral feature of a modern workplace. You will easily adjust ZEDO meeting tables to your changing needs and the size of your team. With supplementary units, you can extend a meeting table and set up to 20 workspaces.



101

ZEDO

# NOVA Wood

NOVA Wood tables offer a subtle sense of luxury and create warm atmosphere thanks to their natural elements. The key distinct feature of these tables are elegant and uniquely patterned solid ash wood legs.



reddot award 2019  
winner

- > 64  
DESKS
- > 106  
CONFERENCE  
& MEETING  
TABLES
- > 134
- > 136  
HIGH  
TABLES
- > 146  
OCCASIONAL  
TABLES

The meeting table has an ash tree veneer insert which is a well-thought out cable management solution for a meeting space.



102

103

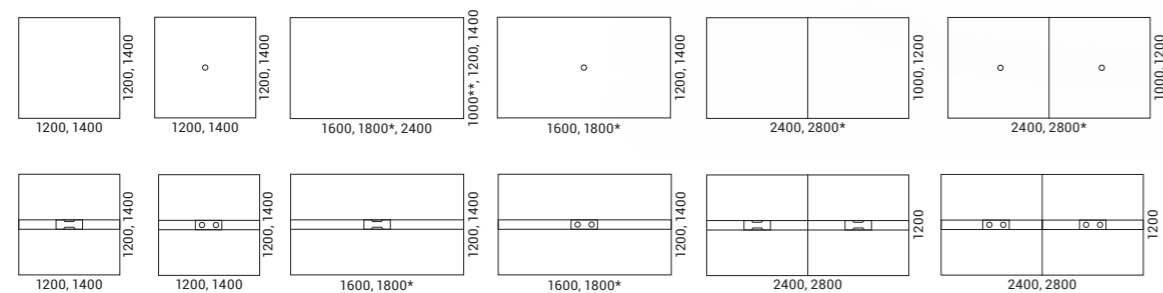

\* - only 1200  
\*\* - only 2400

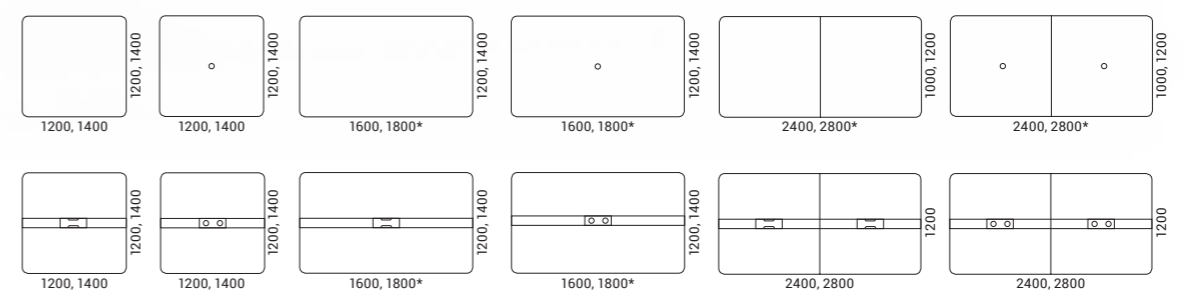

\* - only 1200

CONFERENCE  
& MEETING  
TABLES

CONFERENCE  
& MEETING  
TABLES



PET felt  
BA11

VALENCIA C5  
DV07



CONFERENCE  
& MEETING  
TABLES

# NOVA

## Wood

## Multipurpose



106

A cosy multipurpose island for efficient meetings

The multipurpose meeting table can serve as a cosy island for convenient team meetings in an open-plan office. Thanks to the three different height options of the tabletop and the well-designed accessories, the multipurpose NOVA Wood table will enable you to create a more private, practical space for both long meetings or spontaneous stand-up meetings for coming up with quick solutions or generating ideas.

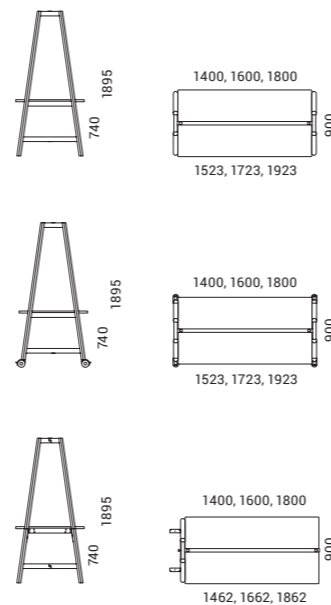

\* Tabletops are also available with cut out for power socket.

- > 64 DESKS
- > 102 CONFERENCE & MEETING TABLES
- > 134 HIGH TABLES
- > 146 OCCASIONAL TABLES

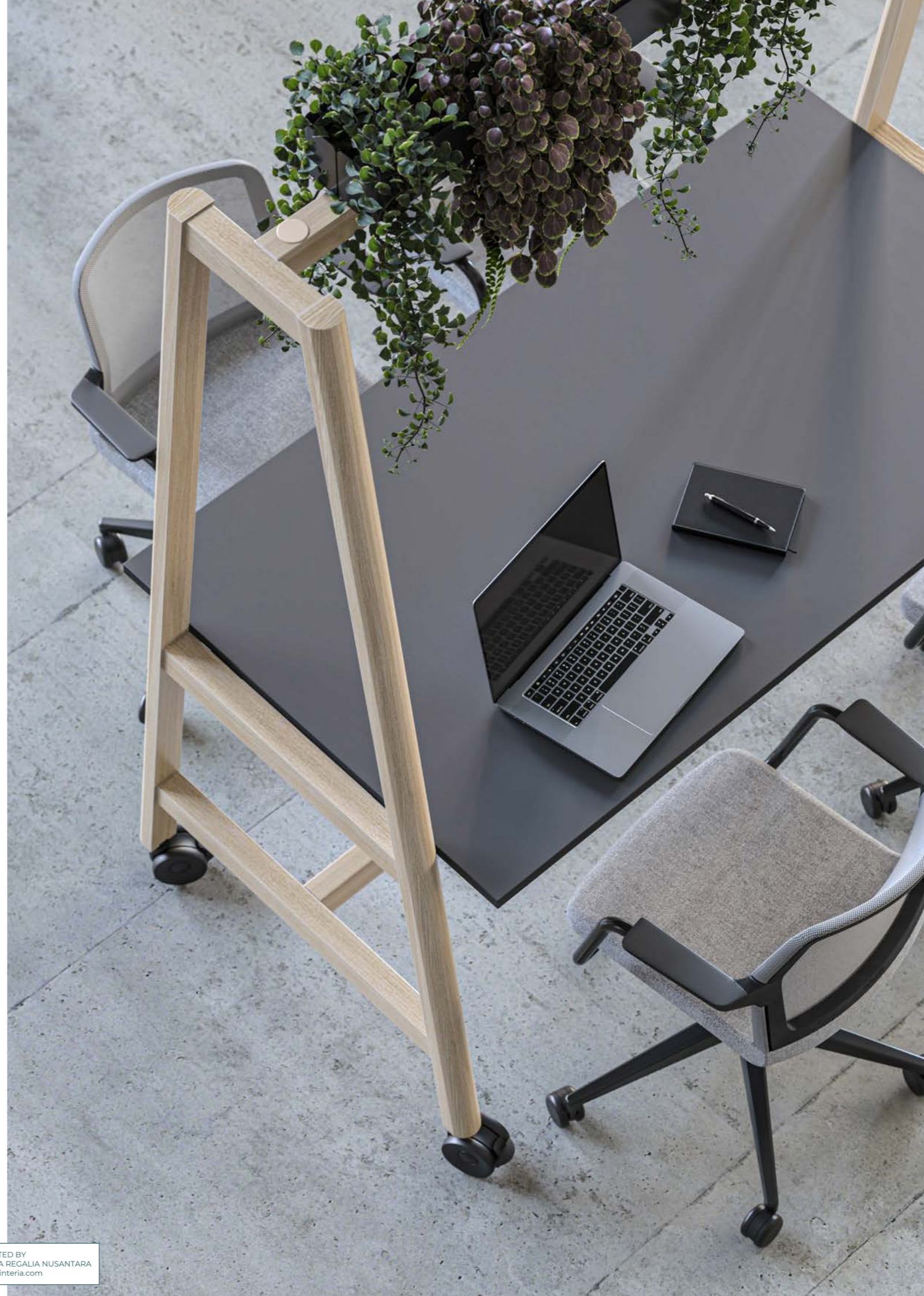

Design by Roberto Lucci & Paolo Pampanoni

## Exclusive meeting tables

The Italian design of the tables is based on the harmony of straight and curved lines.

## Quality is in the details

The rectangular tables come with soft closing grommet, beautifully framed in metal and concealing the box for wire management. This functional detail becomes invaluable in long meetings.



108

109

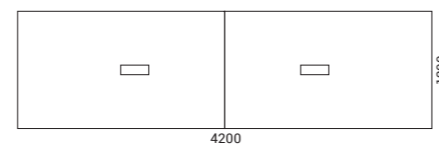
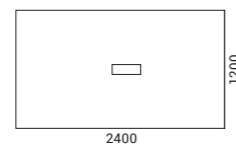

The elegant three-part curved steel legs are crafted using difficult technology and are the ultimate distinctive feature of the system. The solid thick tabletop increases the sturdiness and the visual impact of the tables.

110

AUSTEA  
GT04

111



## A universal choice

Intelligently designed solutions allow you to create aesthetically pleasing and well-organized meeting areas.



112

Special desk inserts are functional and playful elements which can be of a different colour than the desktop and can efficiently conceal internet and power boxes. In addition, each cable under the table passes through horizontal and vertical cable ducts.

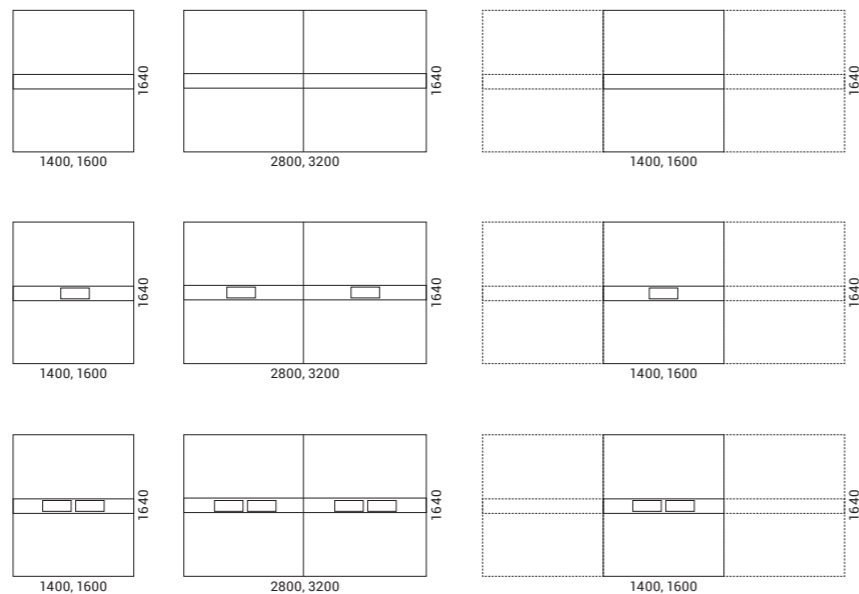

NOVA

> 70  
DESKS

> 138  
HIGH  
TABLES

> 146  
OCCASIONAL  
TABLES

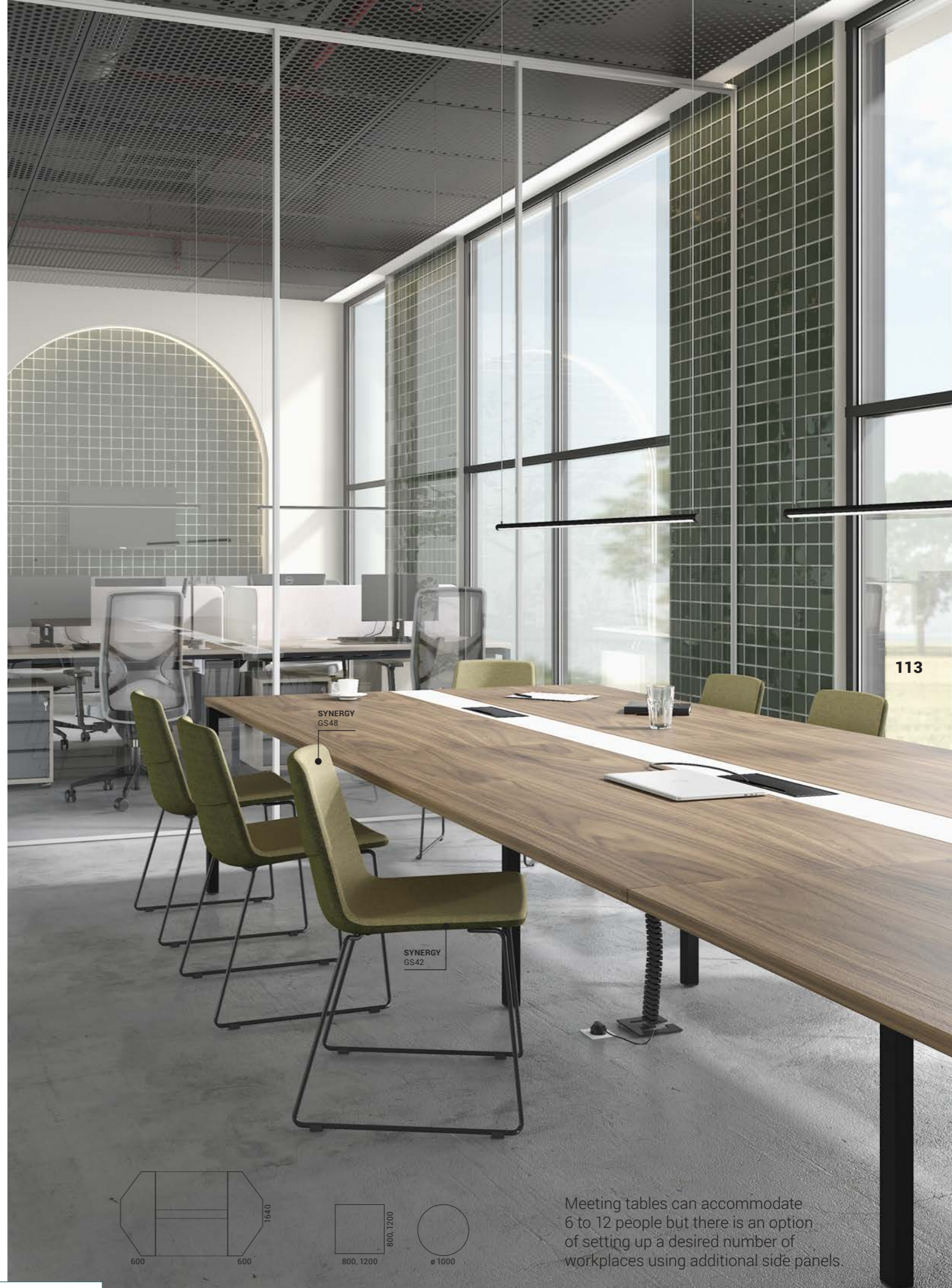

113



Meeting tables can accommodate 6 to 12 people but there is an option of setting up a desired number of workplaces using additional side panels.

CONFERENCE  
& MEETING  
TABLES

# AIR

Design by Gediminas Juška

> 76  
DESKS

> 462  
EXECUTIVE  
FURNITURE

AIR meeting tables offer a variety of different shapes and capacities ranging from round tables for a few people to rectangular tables which can be joined together to form a large conference space. These tables have an option for hidden cable management so you can keep the tabletop as tidy as possible while charging your laptop or mobile phone.



114

The central cover can be removed to reveal a channel that holds accessories and closed for a neat and tidy conference table.

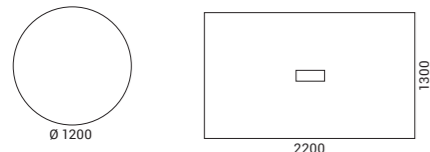

AIR



STEP Melange  
GL17

STEP Melange  
GL20

PET felt  
BA08

# FLIP-TOP FLIP-TOP.II

Space-saving  
meeting tables

A FLIP-TOP desk has a desktop that can be flipped up in a vertical position and comes with casters. This will not only enable you to save space but also easily prepare the office space for meetings, conferences, trainings or collaborative work.

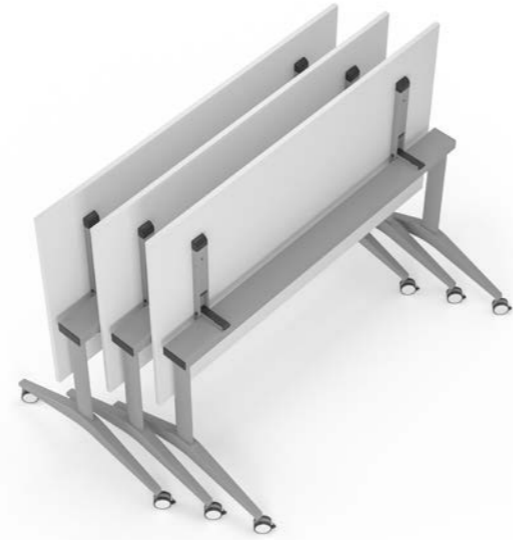

116

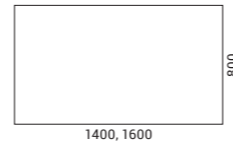

## FOLDING

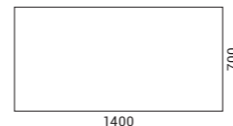

FLIP-TOP / FLIP-TOP.II / FOLDING



\* only 600

FLIP-TOP.II

# FORUM

> 146  
OCCASIONAL  
TABLES

Affordable, durable  
and long-lasting  
meeting tables



118

Round tabletops and bases ensure efficient use of the entire table area and facilitate communication with your colleagues and partners. Choose from our extensive range of table sizes to find an option that will offer the most comfort to you and meet your specific needs.

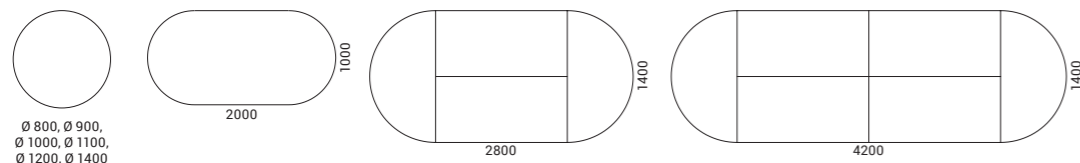

FORUM

# OPTIMA

> 82  
> 83  
DESKS  
> 147  
OCCASIONAL  
TABLES

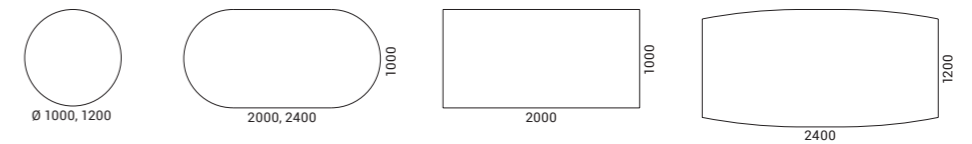

119

# T-EASY

> 80  
DESKS

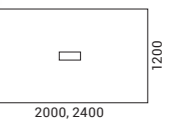

OPTIMA / T-EASY

# WORKLAB

Design by Baldanzi & Novelli designers

“

The idea arose from the need to have a dynamic workspace and to break free from orderly office schemes. It has been designed to fit in all those spaces that need to be modified on demand.

Baldanzi & Novelli designers

Distinctive design and ensured mobility

This multifunctional piece of furniture was designed by the Italian design studio Baldanzi & Novelli designers. The construction of WORKLAB is based on a metal frame that is robust, durable and easy to clean. Its shape is simple, but also stands out in a traditional work environment. Large castors are an integral part of the WORKLAB design, ensuring the mobility of this piece of furniture and enhancing its unique image.

120



121



## Power solutions

The cable tray and well-thought-out placement of the power socket and power cord outlet ensure that convenient access to electricity is maintained when changing the WORKLAB's location.

Make your workspace more dynamic

WORKLAB is a multifunctional piece of furniture that allows you to comfortably use a conference wall, whiteboard, temporary workplace, shelves or make a private space where it is needed the most. Combining all these functions creates a modern and dynamic environment where there is a flow between individual work and team work.

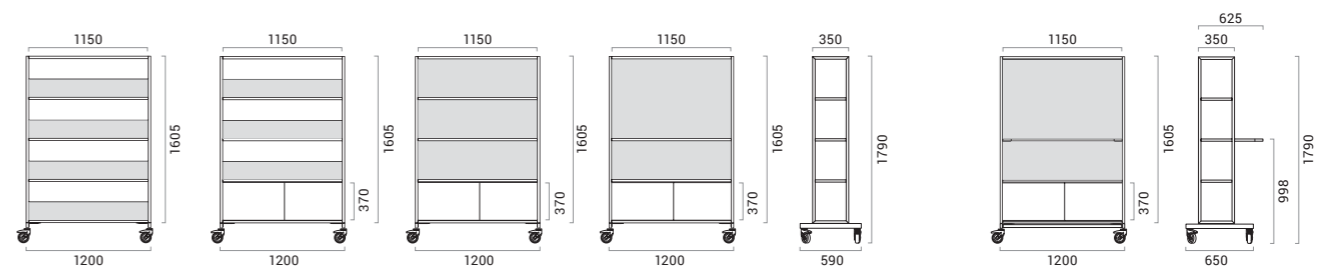

## For user convenience and cosiness

Once you have customised the model that is right for you, you can also order a hook, shelf or side panels for additional functionality. Using these accessories, you will be able to conveniently store things or create more private spaces. They will also become playful design elements in the interior.



# MEDIA

A smart solution  
for meeting areas

It gives you an easy way to show presentations and to participate in video conferences and meetings. The conference wall can be attached to various types of meeting tables or high tables. You can also choose MEDIA wall with a power socket and with a cable port for wire management.

124

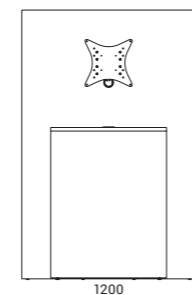
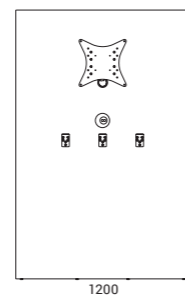
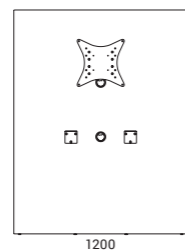
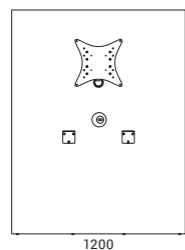

HIGH TABLES

# ROUND Multipurpose

> 84  
CONFERENCE  
& MEETING  
TABLES

Features for  
all scenarios

The ROUND Multipurpose tables are ideal for short or longer meetings, informal discussions, creative work in a team or individual work. The collection consists of tables in three heights and two tabletop depths.



reddot winner 2025



GERMAN  
DESIGN  
AWARD  
WINNER  
2025

126

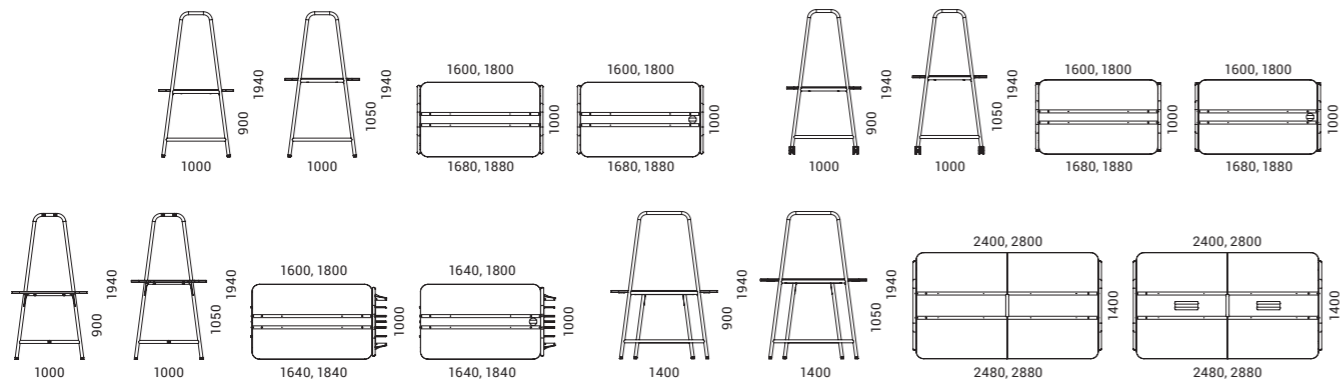

ROUND Multipurpose

INTERIA DISTRIBUTED BY  
PT INTERIA REGALIA NUSANTARA  
hello@by-interia.com

HIGH TABLES

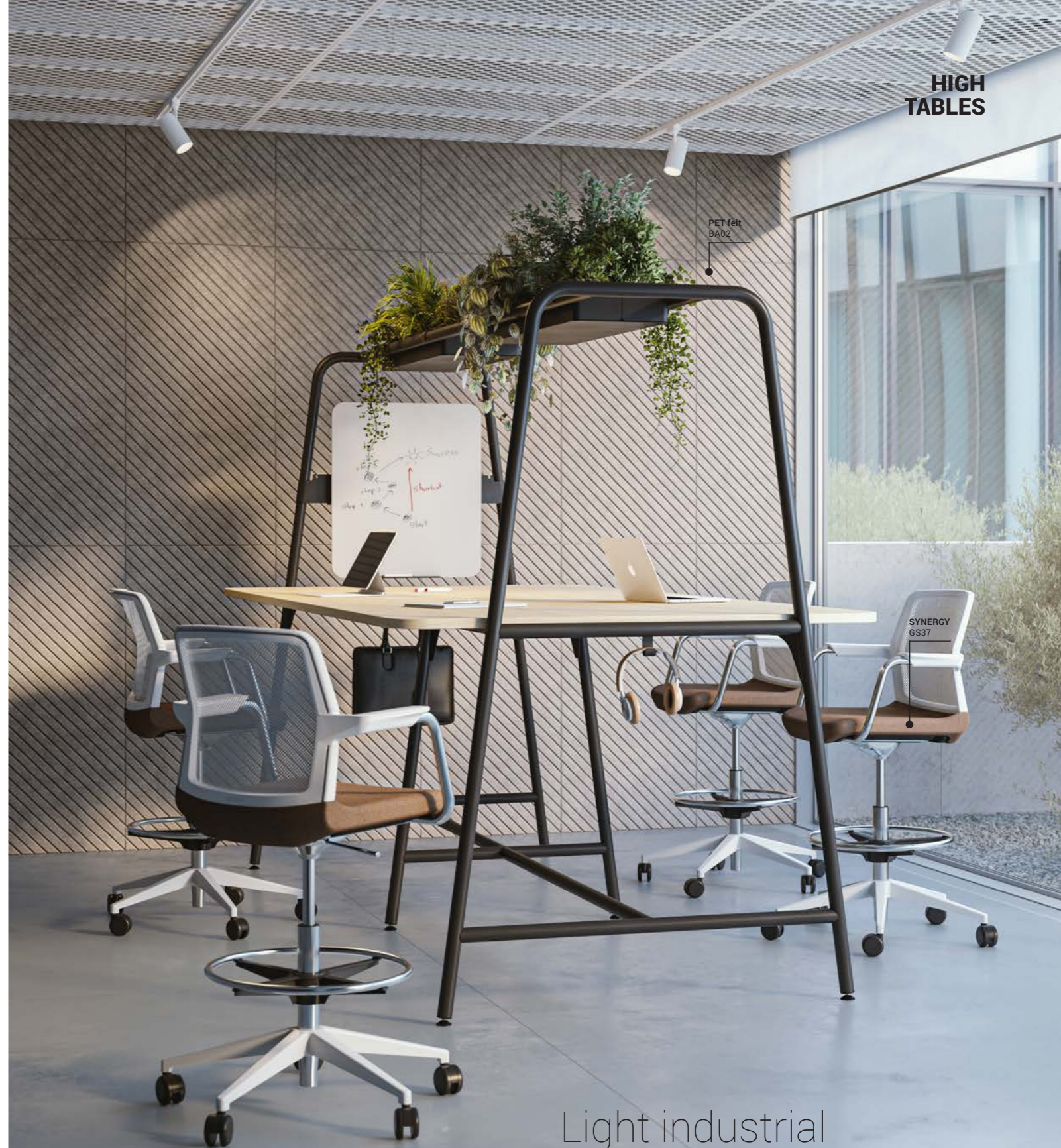

Light industrial  
design

The design of the table blends the typical characteristics of strict industrial design with a gentle contemporary aesthetic. The bent metal legs, rounded corners of the table tops, and chamfered edges reflect subtle rounded shapes. The curved metal table legs lend the furniture a sense of elegance.

ROUND Multipurpose

## HIGH TABLES

### Variety of functional solutions

A monitor hung on the table's metal legs allows you to integrate technology into your meeting spaces, while a whiteboard will help you ensure that every idea is recorded.

Side shelves hung on the table's legs are ideally suited for storing small items needed for meetings or daily tasks, while an attachable hook is perfect for hanging your bag.

### For a stylish workplace

You can complete the look of your table by incorporating planter boxes, where the plants bring a cozy and inviting atmosphere to the room. You can also choose a perforated metal top cover. It can be used to decorate the workplace with garlands of light bulbs or plants for added style.

## HIGH TABLES

### Irreplaceable in dynamic environments

The multifunctional tables with 1000 mm deep tabletops can be fitted not only with supports but also with castors. This makes it easy to move these tables to different areas of the office.



HIGH  
TABLES



VALENCIA C5  
DV01

The ROUND Multipurpose tables are ideal for short or longer meetings, informal discussions, creative work in a team or individual work.

# PARTHOS

> 88  
CONFERENCE  
& MEETING  
TABLES

> 144  
OCCASIONAL  
TABLES

## Architectural design

The main design element of the table is a sculptural cylindrical column resembling classical architecture.



132

## Round tables for enjoyable work and conversations

This furniture brings people together and becomes an eye-catching interior accent in both formal and informal environments. Tables like these allow us to see and hear each other and actively share ideas and information.

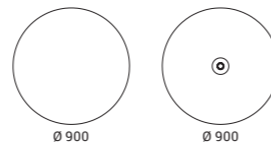

## Improving the acoustic environment

PET felt features acoustic properties. The porous surface absorbs sound, while the vertical cut-outs disperse some of the sound waves. We recommend combining these tables with the PARTHOS acoustic columns. This will ensure a better acoustic environment.



133

HIGH TABLES

# NOVA

## Wood Multipurpose



134

### Functional accessories and power options

With the help of accessories, you can create a functional and uniquely styled space. You can easily attach a display screen or a writing board to the table legs. Meanwhile, the shelving units will be a perfect place to accommodate water bottles or small office supplies. The office plants placed on top of the shelving units will help to create a more homely and private atmosphere. The electrical solutions integrated into the tabletop will ensure convenient access to power for your meeting equipment.

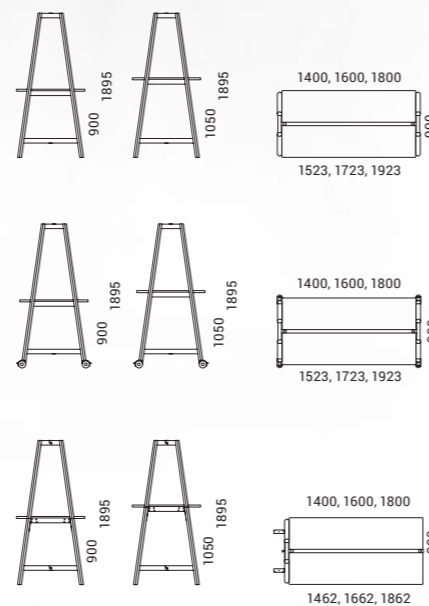

\* Tabletops are also available with cut out for power socket.

NOVA Wood Multipurpose

> 64

DESKS

> 102

> 106

CONFERENCE & MEETING TABLES

> 136

HIGH TABLES

> 146

OCCASIONAL TABLES

HIGH TABLES



NOVA Wood Multipurpose

INTERIA DISTRIBUTED BY PT INTERIA REGALIA NUSANTARA hello@by-interia.com

HIGH  
TABLES

# NOVA Wood

A touch of nature  
in your office!

Perfect for spontaneous meetings with colleagues or a short coffee break, the NOVA high meeting table can become a subtle accent and provide your office interior with some extra warmth.



reddot award 2019  
winner

136



Table height allows you to have a meeting in either sitting position while using high chairs, or standing position which increases the team's engagement, work efficiency, and even health. These tables can also be combined with conference walls, that will let you use multimedia devices while presenting or simply charge your laptop and phone.

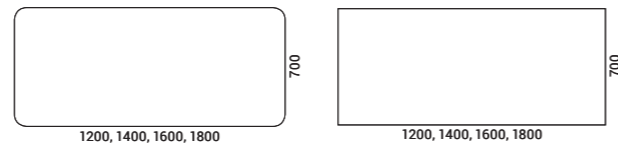

NOVA Wood

> 64  
DESKS

> 102

> 106

CONFERENCE  
& MEETING  
TABLES

> 134

HIGH  
TABLES

> 146

OCCASIONAL  
TABLES



VELITO  
GV04

INTERIA DISTRIBUTED BY  
PT INTERIA REGALIA NUSANTARA  
hello@by-interia.com

NOVA Wood

HIGH  
TABLES

# NOVA

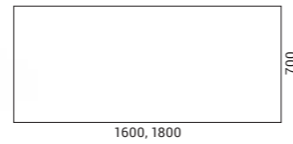
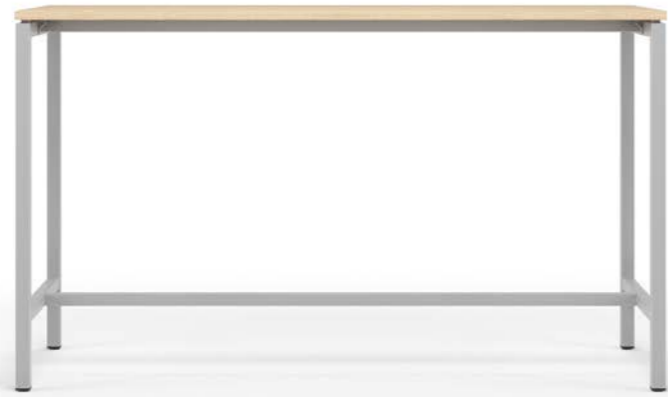

> 70  
DESKS

> 112  
CONFERENCE  
& MEETING  
TABLES

> 146  
OCCASIONAL  
TABLES

HIGH  
TABLES

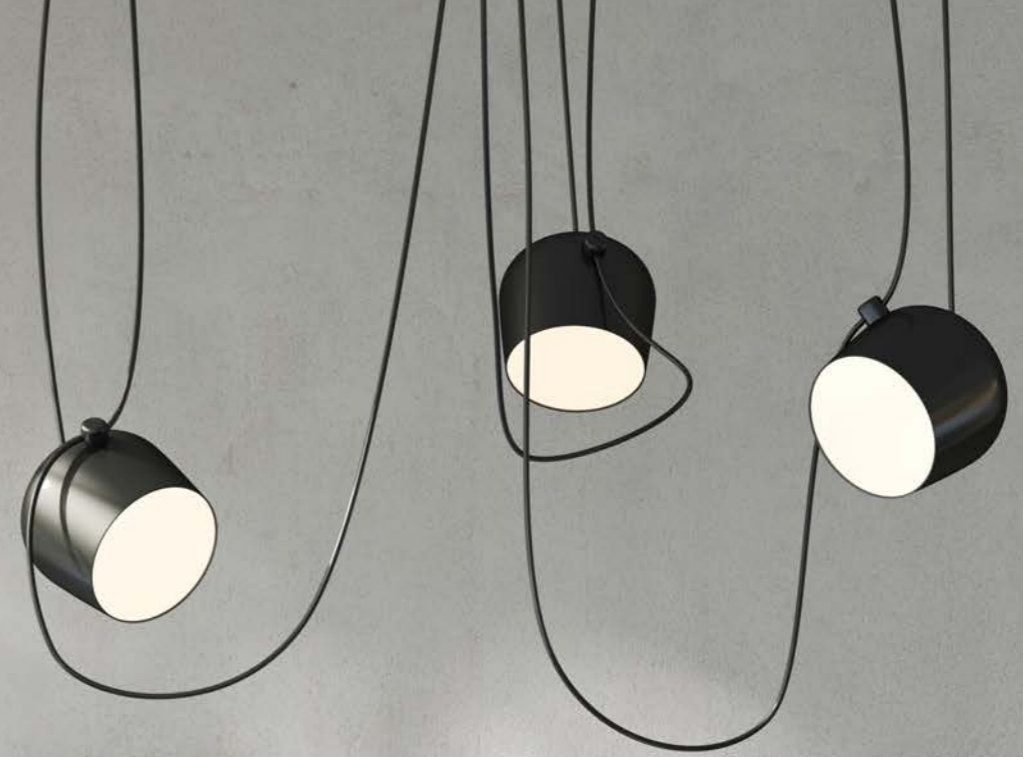

138

# LIGHT

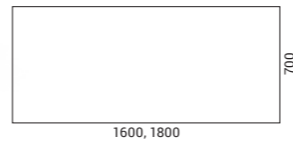
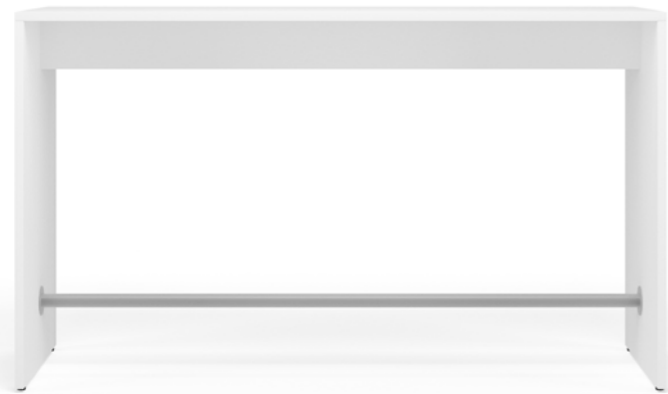

NOVA / LIGHT

NOVA

# ZooZoo

Designer Annie Lee

> 96  
CONFERENCE  
& MEETING  
TABLES  
  
> 432  
POUFS

“

*True collaborations happen when we embrace different ideas, include one another, and make room for one more.*

Annie Lee



140

Make room for  
one more idea

With a modern and light design, the ZooZoo collection of tables and poufs that fit easily under them invite you to sit down, have a conversation and share ideas.

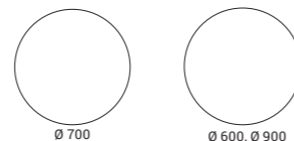

Coffee tables  
for rest breaks  
and informal  
meetings

With an atypical height of 69 cm, the ZooZoo coffee tables can be used for putting down a cup of coffee, a magazine or a smart device during a rest break or writing down ideas during an informal meeting.





VALENCIA C5  
DV01



SYNERGY  
GS17

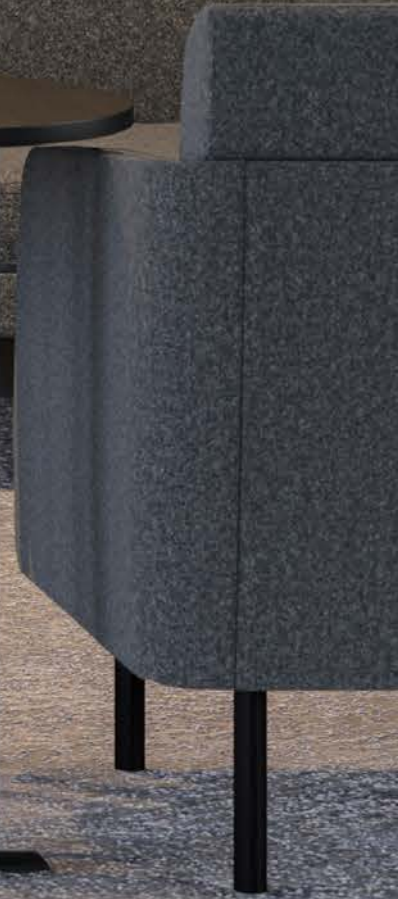

# PARTHOS

> 88  
CONFERENCE  
& MEETING  
TABLES

> 132  
HIGH  
TABLES

Architectural  
design

The main design element of the table is a sculptural cylindrical column resembling classical architecture. The coffee tables are perfect for cosy and enjoyable conversations over a cup of coffee or tea.



144



Many stylish  
combination  
options

The wide range of PET felt colours is another important distinctive quality of the collection. A wide choice of combinations gives you plenty of creative options for furnishing various spaces and maintaining a consistent style throughout the interior.

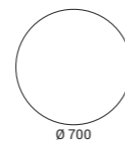

SYNERGY  
GS48

PET felt  
BA10

# NOVA Wood

A well-designed and compact addition to any lounge area. These tables come in round and rectangular shapes which will definitely find a place in your interior.



# OPTIMA

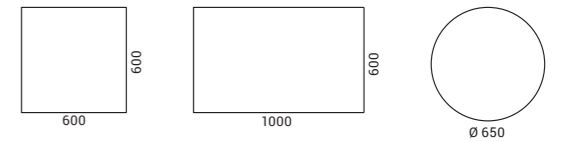

# NOVA

146

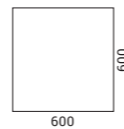

# AMBER

147

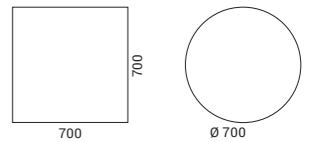

# FORUM



# MOBI

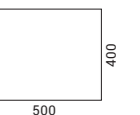

OCCASIONAL  
TABLES

OCCASIONAL  
TABLES



ERA  
GC02



ERA  
GC02

# STORAGE

## CABINETS & SHELVING

---



COMBUS

> 152



WORKLAB

> 120

150



CHOICE

> 158



UNI

> 166



NOVA

> 170

## LOCKERS

---



CHOICE

> 178



NOVA

> 184

## PEDESTALS

---



NOVA

> 186



OPTIMA

> 187

151

## TOWERS

---



BOXI

> 174

# COMBUS

More than just a shelf

COMBUS is a modular shelving system that not only serves the function of a traditional shelf, but is also a good solution for shaping and dividing spaces. It consists of different types of shelving, which are designed to be placed in an open space, against a wall or on top of cabinets. The COMBUS collection has all the key features required to become an essential part of the modern office, where different types of spaces are intertwined – it is functional, has an easily adaptable design and is environmentally friendly.



152



153



COMBUS

COMBUS

Different options for different needs

The COMBUS shelving system consists of freestanding shelving units, planter shelf units, shelving units for mounting on cabinets. This shelving system can be used in the middle of a space, against a wall or shaped as a corner.



154



Shelving units for mounting on cabinets – ready-made configurations

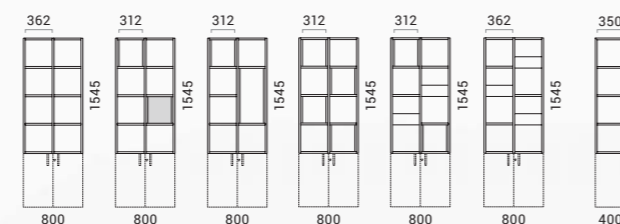
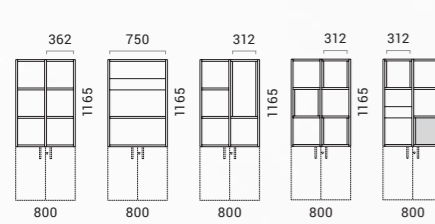
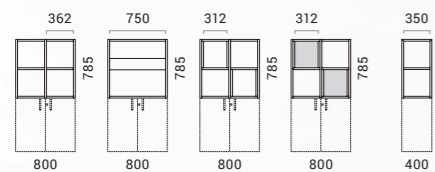

Shelves

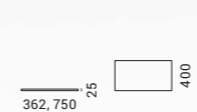

Open and closed shelf boxes

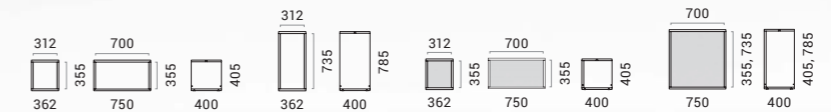

Planter boxes

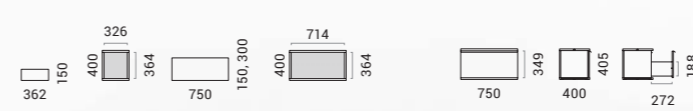

Cabinet with drawer

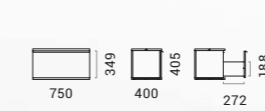

Shelving units – modular configurations

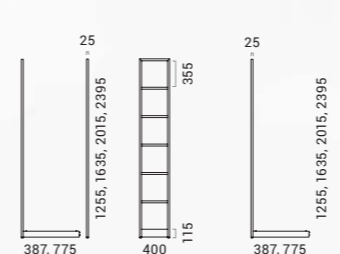

Planter shelf units – ready-made configurations

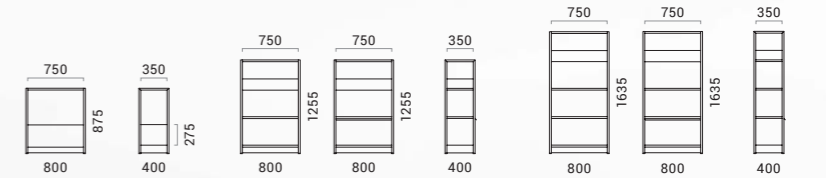



Your freedom of choice!

We offer a wide range of storage solutions and functionality thus you will be able to select or create customized cabinets best suited for your office space.

158



159

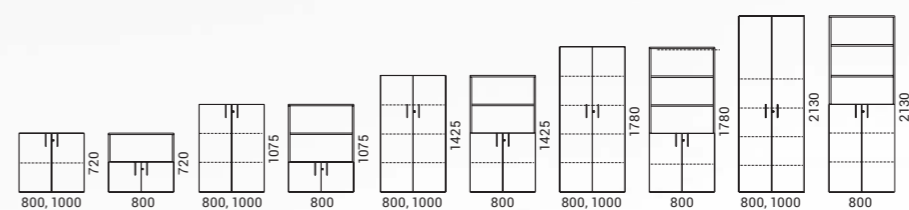
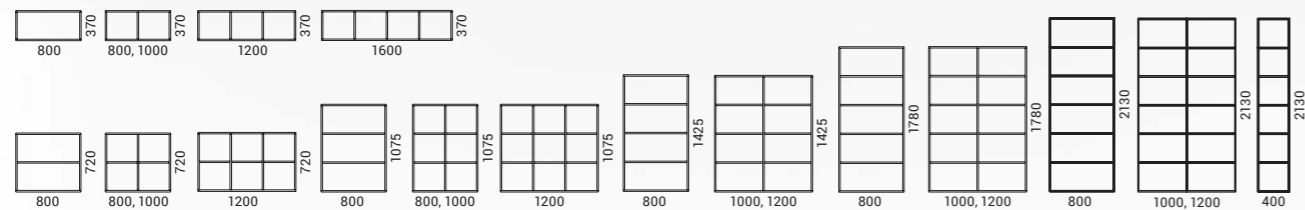

**CABINETS & SHELVING**

Wide array of cabinets

The system of cabinets offers a choice from as many as 6 different cabinet heights, 3 options of doors and widths, and even 7 different types of bases. Enjoy a complete freedom to choose the one that suits you best!

You can use acoustic doors, cabinets with sliding doors, cabinets with hinged doors and open bookcase storage.

160

Metal baseboard or metal legs will be perfect for those who want to create a minimalist office style. Legs made of natural ashwood will bring you closer to nature in a very subtle manner. Castors will make it easy to rearrange office furniture. Each solution can be your best choice.



3 door types



Open book cases      Hinged doors      Sliding doors



4 widths



7 base types

**CABINETS & SHELVING**

6 heights



**CHOICE**

**CHOICE**

## Practical approach

One of the greatest advantages of CHOICE storage units is that they offer a convenient and practical internal layout.

## Endless combinations

You can easily create your own unique design by combining different cabinets. Also, a good idea is to combine different types of textures: tapestry, melamine and natural veneer. Choose from a wide range of materials and colors to create desired combinations that will blend nicely into your office.

162

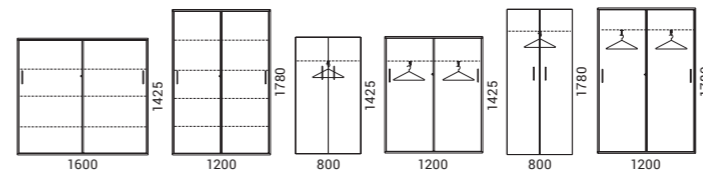
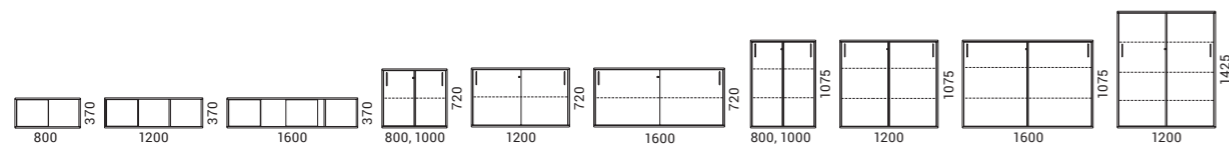



## Well-organized storage of office materials

A large selection of accessories allow you to arrange the inside of the cabinets based on your individual needs.

166

167

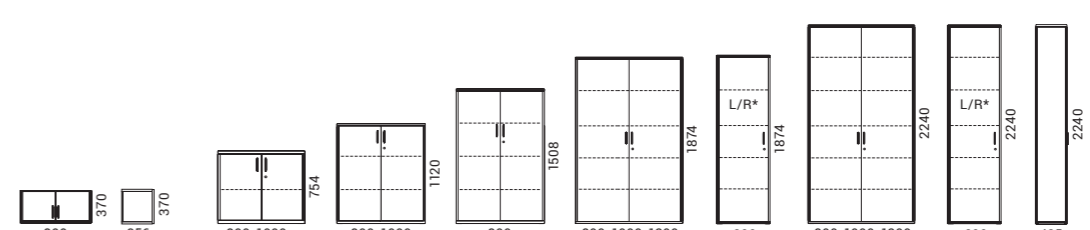
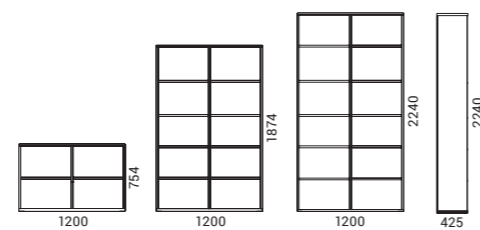
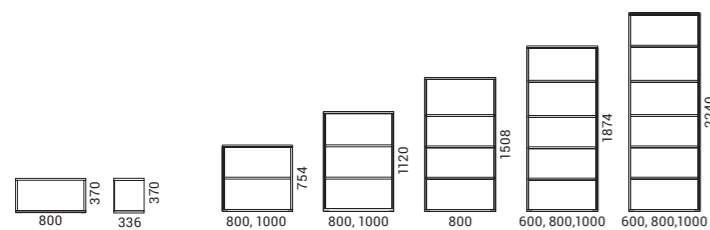

\* - left/right

## Colourful details

An upholstered back of the cabinet adds colour to your office space and absorbs noise. If you choose a cabinet with a special back suitable for writing on it, you will have an additional space to capture your ideas.

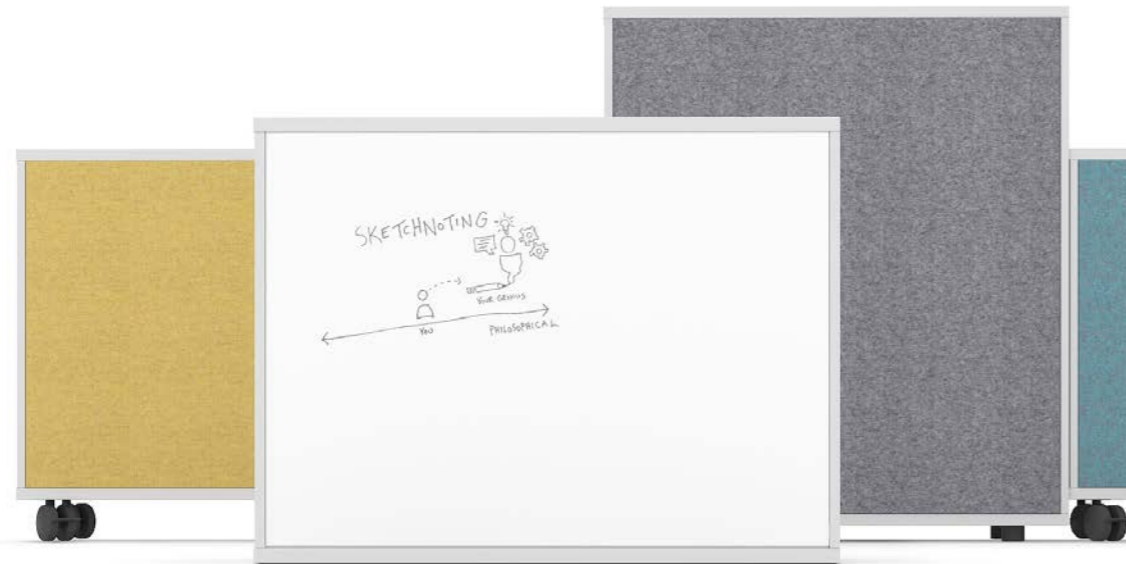

168

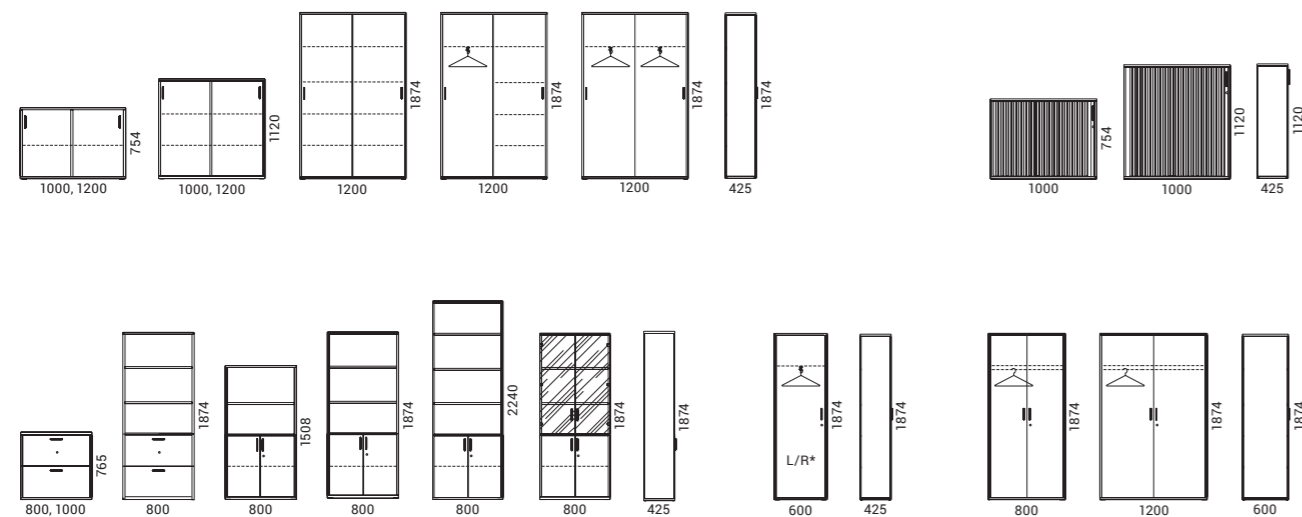

\* - left/right



Wonderful simplicity

Simple and ergonomic solutions are ideal for setting up large office spaces and help to create a coherent interior style.

170



171

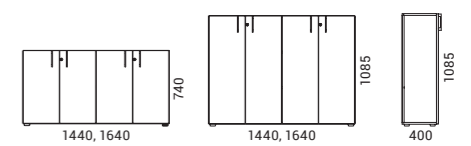
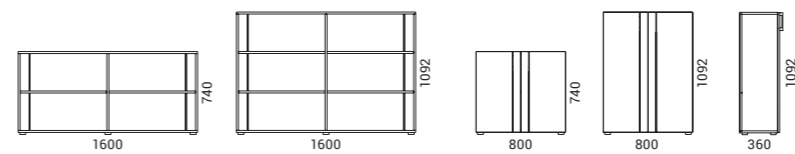
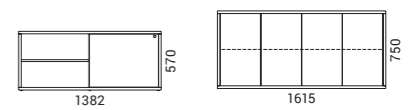
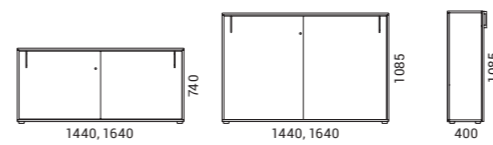
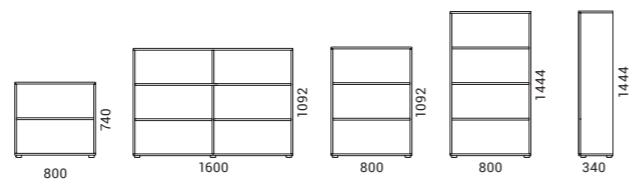
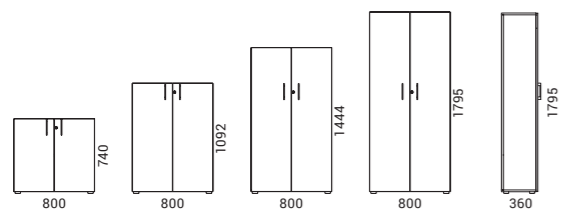

**CABINETS & SHELVING**

# Adapted to desk height and depth

The height and depth of the cabinets match the bench desks available in the product line.



172

# Decorative elements

Choose decorative Plexiglas inserts and handles for your cabinet to add a nice touch to it.



**NOVA**

**CABINETS & SHELVING**



# BOXI

Minimalist style – unlimited possibilities

BOXI storage tower is a simple and universal solution designed to accommodate all office essentials for the daily needs in the office.



174



\* - left/right

BOXI

Flexible arrangement of work spaces

Choose a preferred tower height: a 740 mm storage tower can serve as an extension to a fixed-height desk, whereas 1090 mm or 1200 mm options will be a great addition to the sit-stand desks or can be used as a workspace divider. BOXI storage towers with shelves can have either right-hand or left-hand configuration thus they can be easily re-arranged if you decide to change the workspace layout.



175

All storage towers are available in two depths of 800 mm or 820 mm, thus they can be combined with single desks or bench desks.

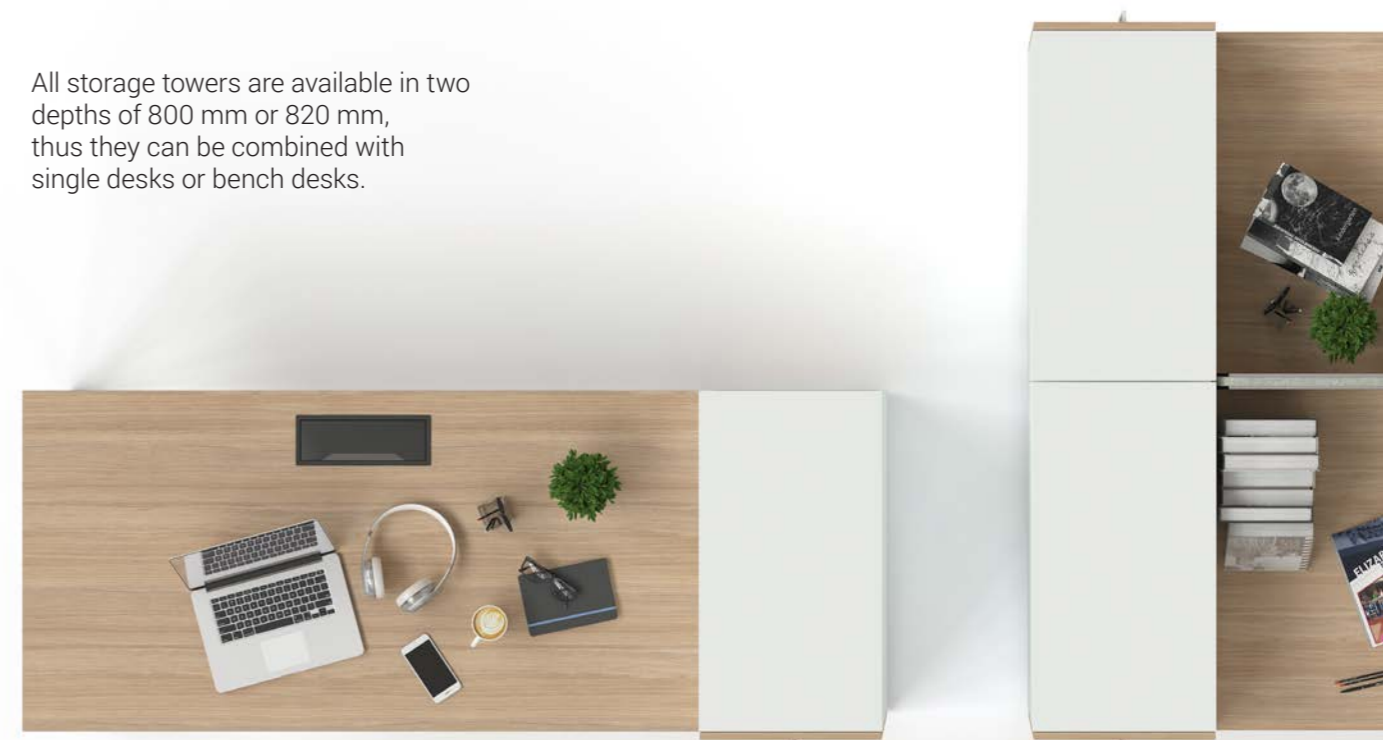

BOXI

## TOWERS

Make the most of  
all available options

Choose spacious shelves or universal file drawers, small shelves with an upholstery lining or small drawers for storing small items. BOXI storage towers with USB or plug sockets will allow you to charge your mobile devices.

176



## Visual versatility

Mix and match various melamine covers or use a planter box to transform the BOXI storage towers into green islands with flourishing greenery which will be a great way for employees to rest their eyes during a break.

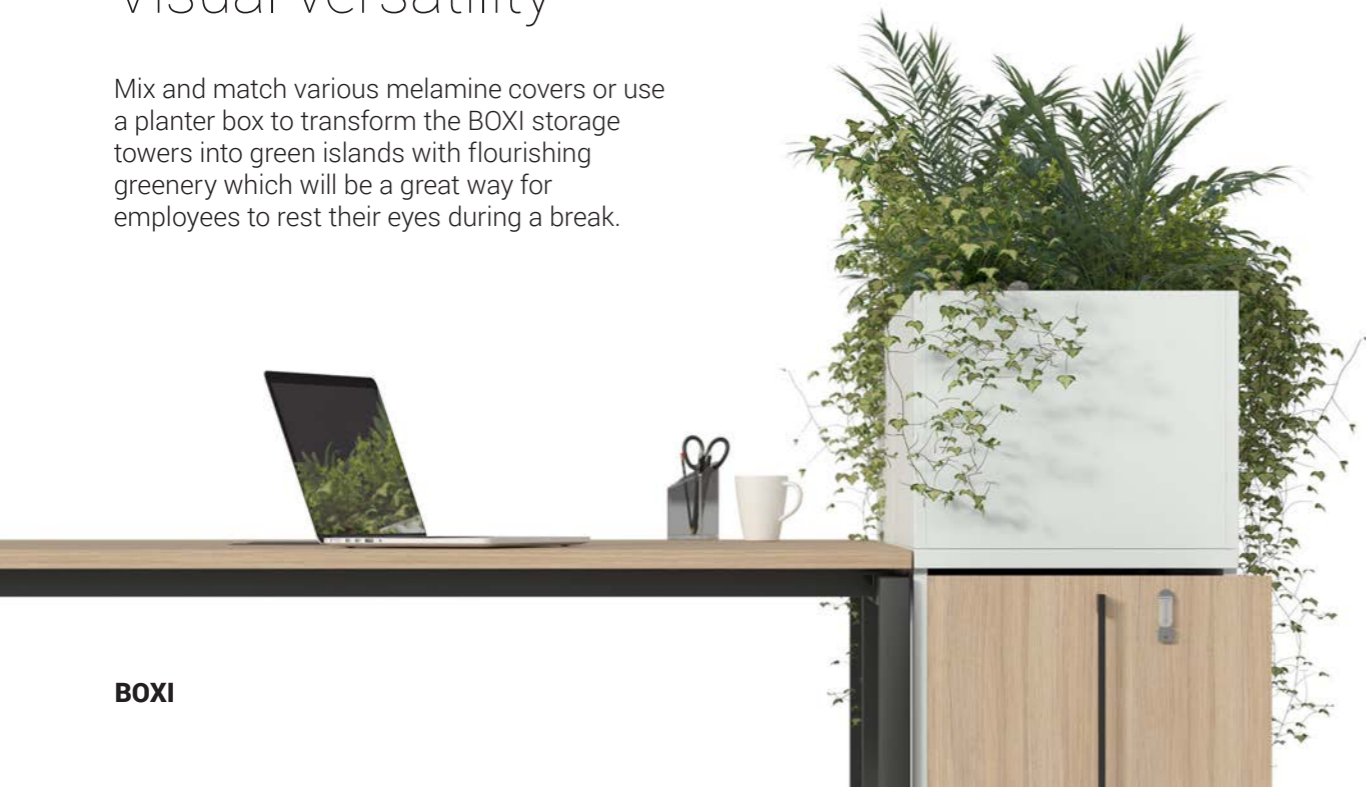

BOXI

BOXI



## Unlock your personal space

Modular lockers are a versatile solution for the secure storage of personal and office items, whether for temporary or all-day use. The CHOICE lockers are ideal for both mobile employees and those with a permanent workplace or office visitors.

178

## Easily customisable modular system

Segments of lockers in different sizes and types will meet various needs, such as storage of both small and larger personal items and office supplies. Combine modules of the same height to create the combination you want. Choose from two available door heights and types – standard or with cut-outs for mail or air circulation.



Fulfilling individual needs

The CHOICE collection offers a wide array of cabinet types, from lockers of three different heights to cabinets with niches for hanging clothes or a short rest break. To complete your locker combination, you can choose planter boxes which are available in two different sizes. You can also choose the minimalist option with a top panel that will give lockers a harmonious look. Metal shelves, a name card holder, or a hook for clothes help create the most practical locker for each user.

Everything you need to create your chosen image

Lockers are a great way to convey your company's image. Use different finishes (melamine, HPL, veneer or even perforated metal) and a wide range of colours to create your chosen image. These lockers can be customised in your company's corporate colours.



Four types of locks

In addition to traditional key-operated locks, we also offer combination locks and electronic locks. Lockers with electronic locks can be intended for personal use or temporary storage by several users.

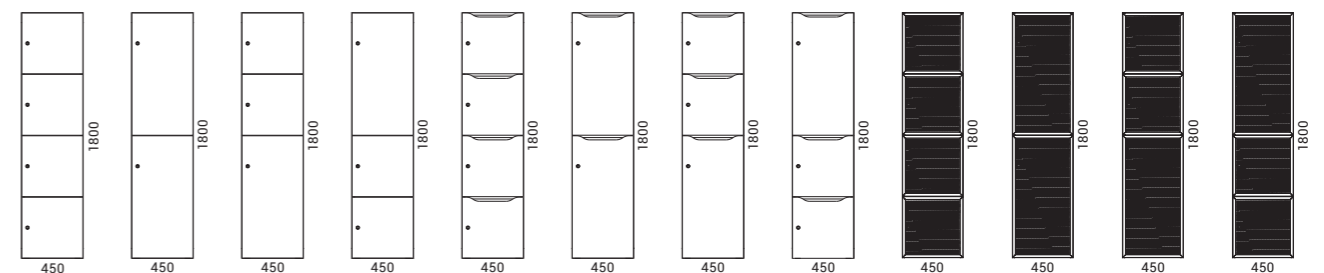
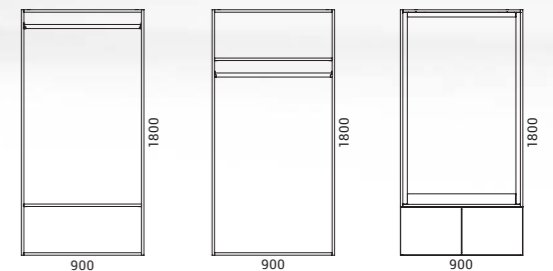
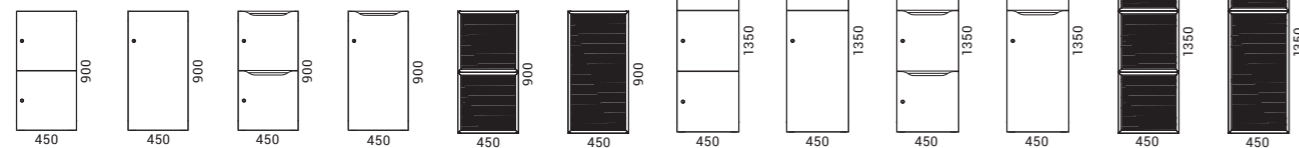



CHOICE

INTERIA  
DISTRIBUTED BY  
PT INTERIA REGALIA NUSANTARA  
hello@by-interia.com

LOCKERS

# NOVA

> 170 CABINETS & SHELVING  
> 186 PEDESTALS

## A privacy feature for any workplace

NOVA is a simple and cost-effective storage solution. With heights of both 1092 mm and 1444 mm, these lockers feature either 6 or 8 compartments. Each compartment is lockable for keeping personal items secure. Locker doors and carcasses are available in a range of Melamine finishes which allows you to easily fit this furniture to the desired office design.

184

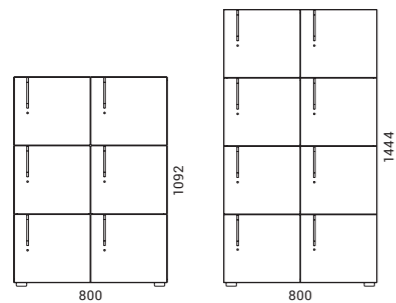

NOVA



LOCKERS



NOVA

# NOVA

> 170  
CABINETS &  
SHELVING

> 184  
LOCKERS

## Universal storage cabinets

We offer suspended cabinets, mobile under-desk cabinets or fixed desk-height cabinets. Cabinets can come with conventional drawers or hanging file drawers.

186



## Customizable design

Design options featuring minimalist handles or no handles allow you to create a neat and "clean" office space. You can also add a playful touch to your workplace by combining different colours of doors or cabinet frames or by incorporating a cushion so that employees could take a seat on the cabinet for a short rest break.

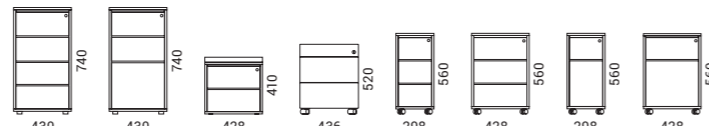

# OPTIMA

## Essential furniture for every workplace

OPTIMA pedestals will definitely expand your workspace and provide convenient storage for files and small items. You can choose from desk height, under desk or mobile pedestals based on your needs and preference. Clear design and high functionality will make OPTIMA pedestals a great addition to any personal working area.

187

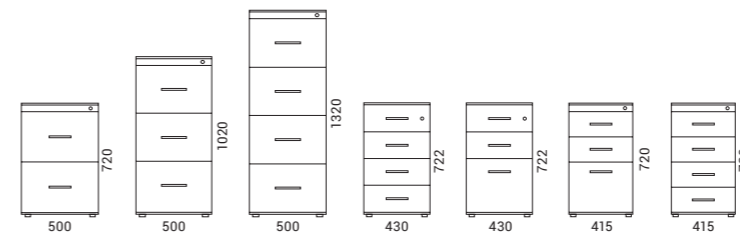

# ACOUSTIC SOLUTIONS

## ACOUSTIC PODS



188



## ACOUSTIC FURNITURE

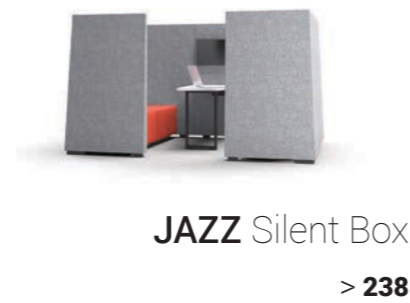

## ACOUSTIC SCREENS & PANELS

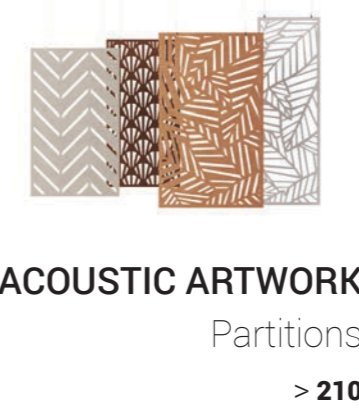
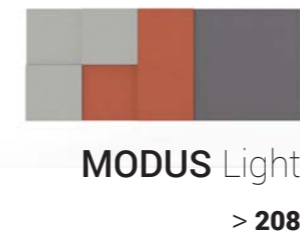
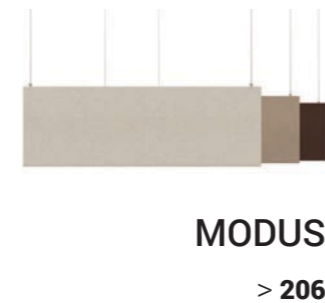

## ACOUSTIC DESK SCREENS

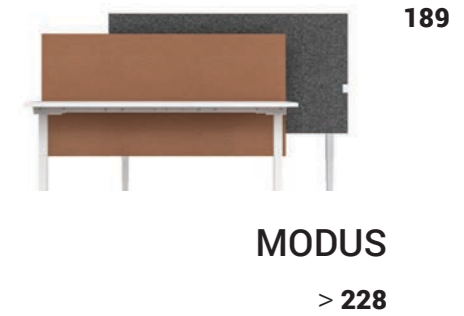

189

# SONUS S

Sleek design,  
ultimate focus

The SONUS S acoustic pods offer excellent sound insulation, creating a pleasantly quiet environment. According to ISO 23351-1:2020, the acoustic pod is classified as sound insulation class B. With the SONUS S door closed, you are shielded from disruptive office noises, and your private conversations remain confidential.

190



Acoustic pod with PET felt back wall



Acoustic pod with glass back wall

Two types for  
different situations

Opt for a configuration with a glass back wall for increased transparency. A glass insert in the back wall not only allows more light into the pod but also preserves visibility into the space behind it, making it an ideal choice for placement in open-plan offices, adjacent to glass partitions, or even next to windows. An acoustic pod with a PET felt back wall is suitable for placement against a wall.

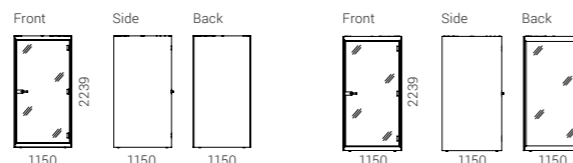

191



## Acoustic pod on castors for enhanced flexibility

If you have a SONUS S model without castors, you can always order them as an option. An acoustic pod on castors offers a highly convenient solution, providing flexibility. These types of acoustic pods not only can be placed side by side but also relocated to different locations as needed, adapting to changes in office layout or requirements. This does not require disassembling the SONUS S.

192



Effective lighting reduces eye strain and ensures a presentable appearance on camera.

The quiet and efficient ventilation system ensures your comfort, even during extended periods of work.

System control – adjust your acoustic pod to your needs.

A power socket with AC and USB fast charger type-A and type-C connectors ensures that you can charge your devices at any time.

**SONUS S**

## What features of SONUS S create an ergonomic environment?

The SONUS S is designed to provide employees with a work environment that is not only comfortable and aesthetically pleasing but also ergonomic. The pod is spacious, allowing you to feel free and unconfined. Use your laptop with ease and place your essentials conveniently on the desktop. Underneath, you will find an intuitively accessible built-in power socket that doesn't occupy space in your work area.

193



**SONUS S**

ACOUSTIC  
PODS

ACOUSTIC  
PODS

194

PET felt  
BA01

VALENCIA C5  
DVO1

195

PET felt  
BA08

SONUS S

SONUS S

INTERIA  
DISTRIBUTED BY  
PT INTERIA REGALIA NUSANTARA  
hello@by-interia.com

ACOUSTIC  
PODS

# SILENT ROOM

ACOUSTIC  
PODS

Choose SILENT ROOM acoustic pods to create functional work areas by dividing or opening interior spaces as necessary. This piece of furniture can be set up in the middle of the office space, near the walls or partitions or inside a wall niche maintaining a clearance of just 300 mm at the top for air circulation.

## S

## M

## L

## XL

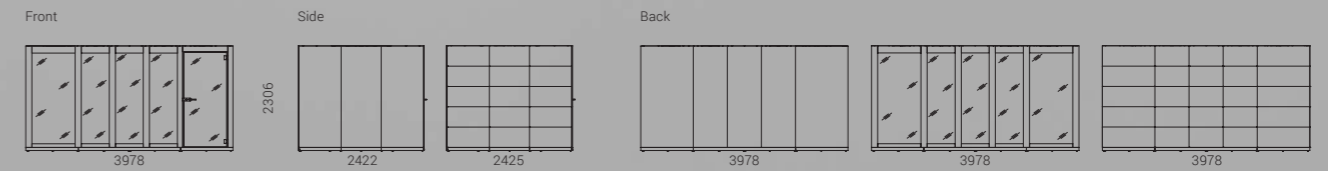
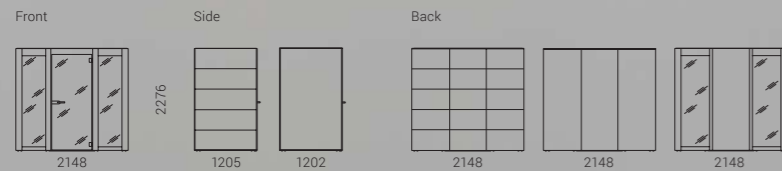
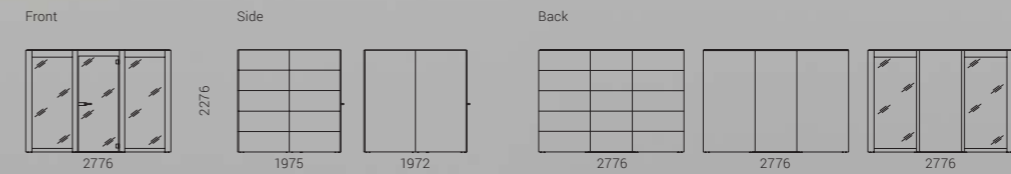

SILENT ROOM

SILENT ROOM

## Less noise, less chaos

Multilayered SILENT ROOM wall structure, hermetic door and ceiling ensure sound insulation. The inner layer of the panels is made from high-class acoustic material that eliminates echo and has excellent sound absorption properties. The upholstered exteriors block out noise effectively and create an acoustically-optimized working environment.

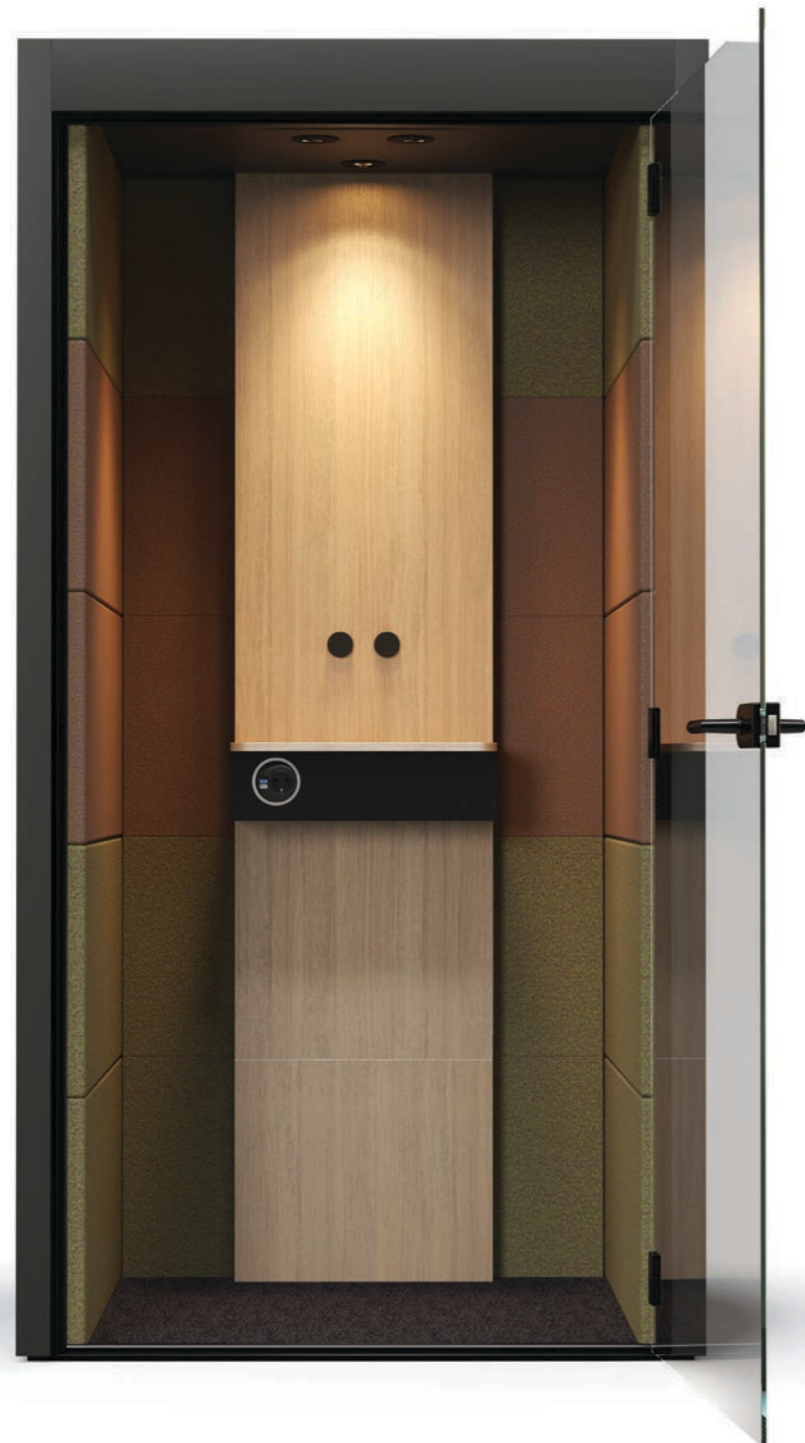

198

SILENT ROOM

## Creative freedom to customise your design

SILENT ROOM offers a variety of design options for you to be able to create a personalised design and desired office mood. The interior and exterior finish can be selected separately. Both melamine and upholstery can be used for the exterior panels.



199

SILENT ROOM

A powerful ventilation system installed at the floor level and in the ceiling of the SILENT ROOM acoustic pod efficiently removes excess heat and high levels of CO2 concentration. A smart control unit selects an optimal ventilation and illumination level, and, if necessary, allows for individual adjustment. Once an employee leaves the SILENT ROOM, intense ventilation is automatically activated to prepare the room for the next user.

## ACOUSTIC PODS

SILENT ROOM is easily adapted to a variety of activities. The acoustic pods come in four different sizes with selectable options such as glass back-wall inserts, high or standard tables, seating, monitor holders, etc.

For users' convenience, the room can be equipped with a power outlet (USB type A and C connectors) or 3-plug power block. The power block can come with in-built sockets, LAN or USB ports in various configurations.

200

## ACOUSTIC PODS

201

SILENT ROOM

ACOUSTIC  
PODS

ACOUSTIC  
PODS

SILENT ROOM

SILENT ROOM

INTERIA  
DISTRIBUTED BY  
PT INTERIA REGALIA NUSANTARA  
hello@by-interia.com

# FREE STANDING

Multifunctional  
acoustic screens

FREE STANDING acoustic screen system offers unlimited possibilities to divide your office with visual and acoustic barriers and even quickly create new areas for specific types of activity.

204



Thanks to their simple configuration, these acoustic screens allow you to easily divide your office space into desired areas. You can choose free standing screens with support feet or mobile screens on casters. The panels are available in a broad selection of sizes and can also serve as workspace dividers.

The screens are filled with a special sound-absorbing foam and provide a class C sound absorption. They can be upholstered with the fabric of your choice. The special connectors can be used to combine, align and hold the screens in place.

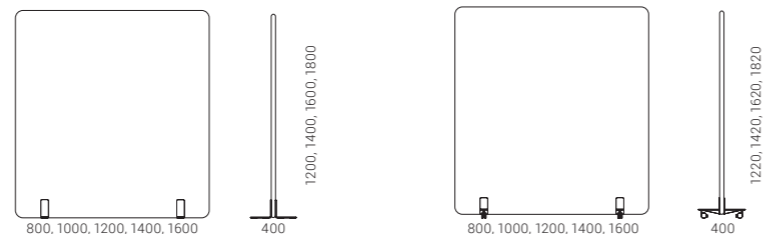

FREE STANDING



# MODUS

206

MODUS acoustic panels will improve your working environment and workplace well-being by absorbing background noise and by creating acoustically private spaces as well as bringing character to the interior space. The acoustic panel system includes wall panels, ceiling (horizontal) panels, and ceiling (vertical, double-sided) panels.

The panels come in different sizes, as large as 1200x1200mm, and are very easily joined together. The panels contain a special patented and certified material designed to efficiently absorb sound.

Double-sided (vertical) panels

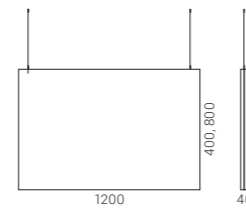

Wall panels

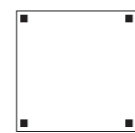

Ceiling (horizontal) panels

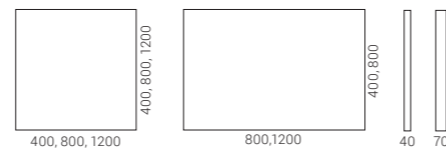

You can choose acoustic panels with different fabric colours on each side to create your own unique interior design. Select from from six different sizes and mix and match different panel depths (40 or 70 mm).



# MODUS Light

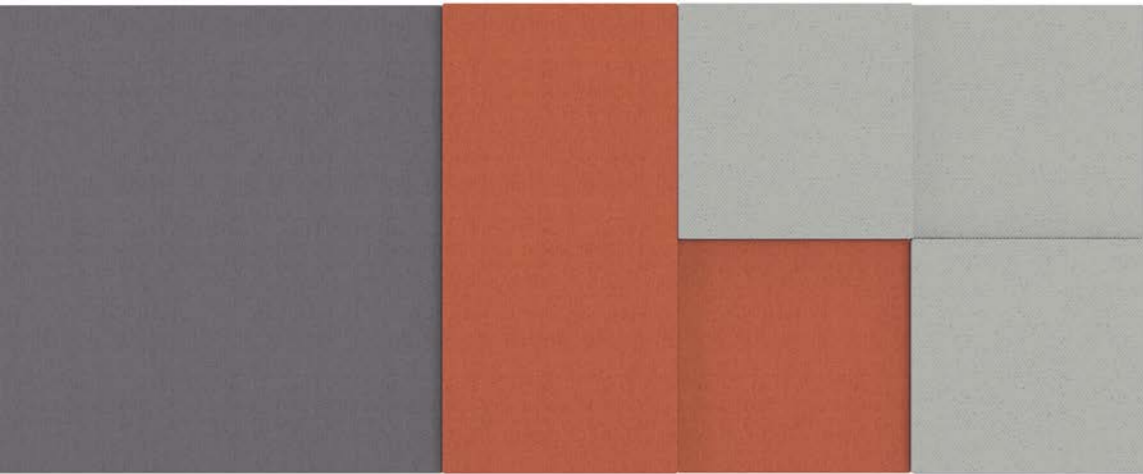

208

## Acoustic comfort in open-plan offices

MODUS Light are lightweight, sound-absorbing wall and ceiling panels that improve office acoustics and serve as an inspiring and functional interior solution.

Panels are made of acoustic foam offering class A (for a 68 mm panel) or class C (for a 48 mm panel) sound absorption.

Thanks to their lightweight design, these acoustic panels are easy to transport and easy to install. MODUS Light are available in three design options: wall and ceiling panels, hanging panels, and Armstrong ceiling panels (integrated or hanged on a wire rope). The panels have multiple different fitting options and can be attached to a number of surfaces, even glass.

Implement your creative ideas by using acoustic panels of three different sizes and two different depths. You can also choose from our wide range of fabrics and a variety of colour options.

Acoustic panel with metal fittings to be fixed to suspended ceiling "Armstrong"

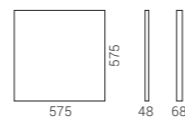

Wall panels



Ceiling (horizontal) panels

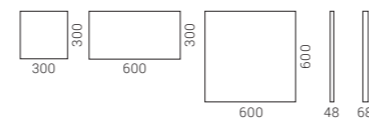

# ACOUSTIC ARTWORK Partitions

> 212

> 214

> 221

ACOUSTIC  
SCREENS &  
PANELS

A creative  
space-dividing  
solution

The acoustic products are made from PET felt and are designed to improve room acoustics. In addition to improved acoustics, these products are also perfectly suited for other functions. For example, partitions offer an easy way to separate workplaces from passages with more intense traffic of people.



210

Wide array of patterns  
and colours

Choose your favourite partition design and colours and set up unique office spaces which will be both visually and acoustically pleasing for your employees.

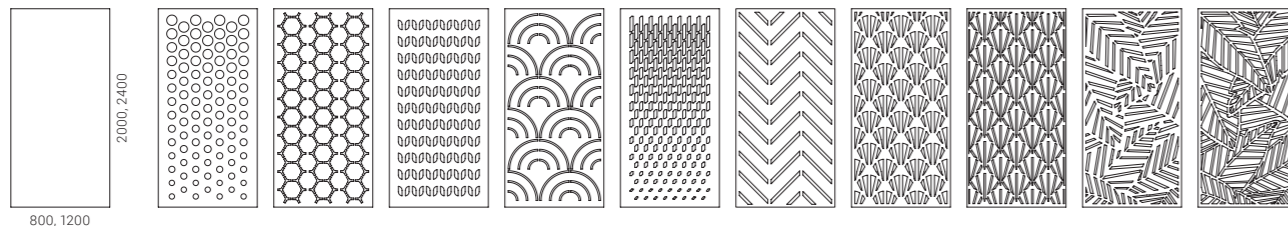

ACOUSTIC ARTWORK Partitions

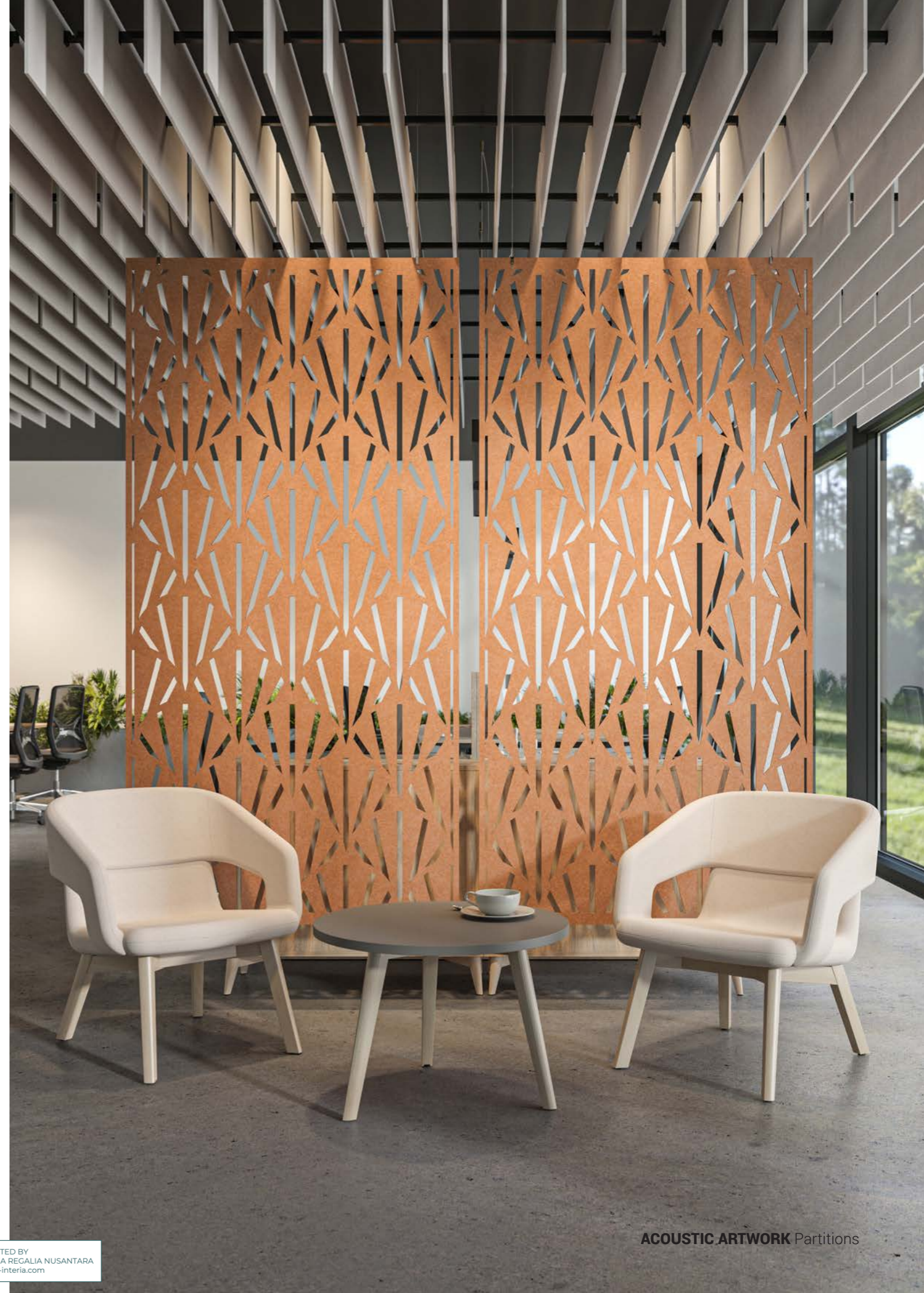

# ACOUSTIC ARTWORK Tiles

> 210

> 214

> 221

ACOUSTIC  
SCREENS &  
PANELS

Acoustics and  
wide range of  
applications

Wall panels will absorb some ambient sounds, reduce reverberation and add a sense of acoustic comfort to your space. The acoustic panels are ideal as decorative elements for a variety of different office spaces: the walls of work areas and lounge zones or corridors and niches.

212



Walls that speak  
for themselves

Acoustic panels which come in five different shapes and a selection of sizes will unleash your creative side. ACOUSTIC ARTWORK Tiles will add a lively touch to your office walls and will help you shape the image of your company.

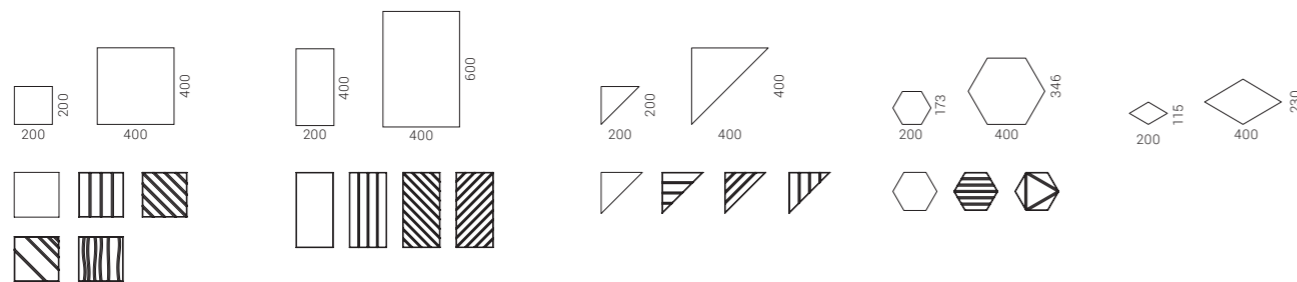

ACOUSTIC ARTWORK Tiles



PET felt  
BA02

# ACOUSTIC ARTWORK Ceiling

> 210

> 212

> 221

ACOUSTIC  
SCREENS &  
PANELS

A fusion of  
acoustics  
and design

The collection consists of three types of acoustic products for ceilings: PET felt acoustic clouds, PET felt acoustic baffles and PET felt acoustic panels for ceiling. Choose your desired colour and this acoustic product will serve as a unique interior design element for your office.

214



## PET felt acoustic clouds

PET felt acoustic clouds are a ceiling solution that improves office acoustics. Just like a shadow, this acoustic cloud is always here to efficiently absorb ambient sounds. With the help of these acoustic elements, you will be able to create an acoustically comfortable environment for both work and relaxation.

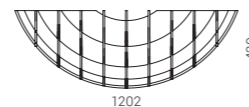

**ACOUSTIC  
SCREENS &  
PANELS**

PET felt  
acoustic baffles

216

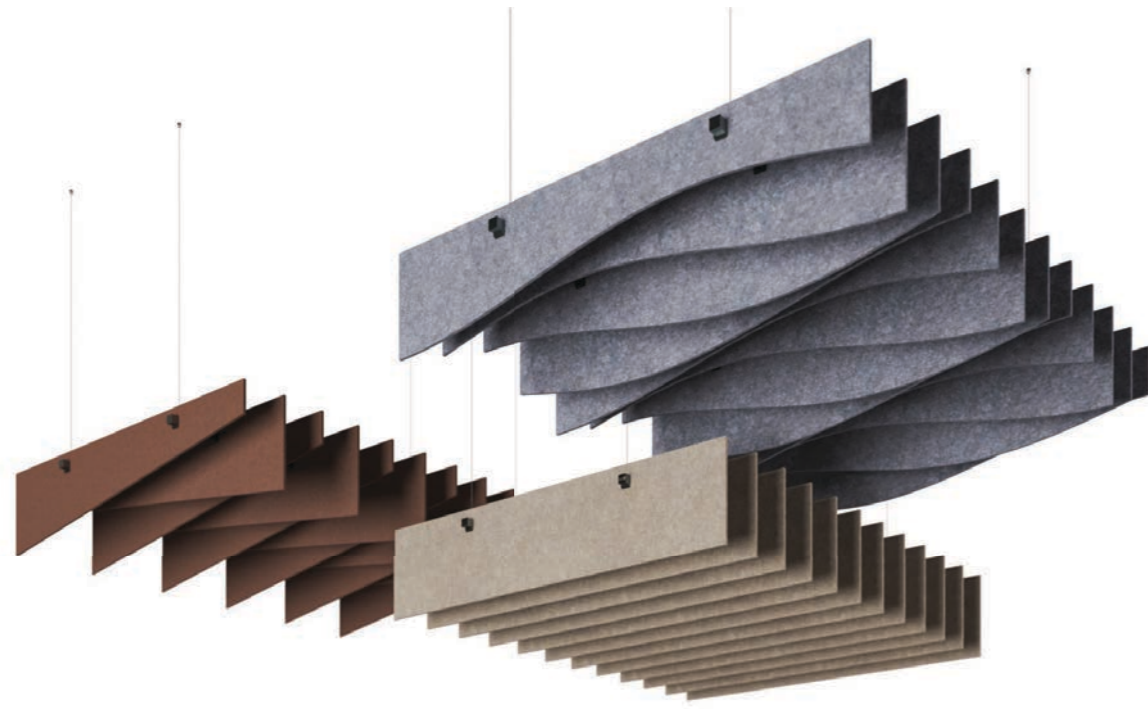

These acoustic segments are formed from PET felt pieces available in three different shapes (Plain, Blade, Wave). It is an effective interior solution for rooms with high acoustic requirements, such as open-plan offices.

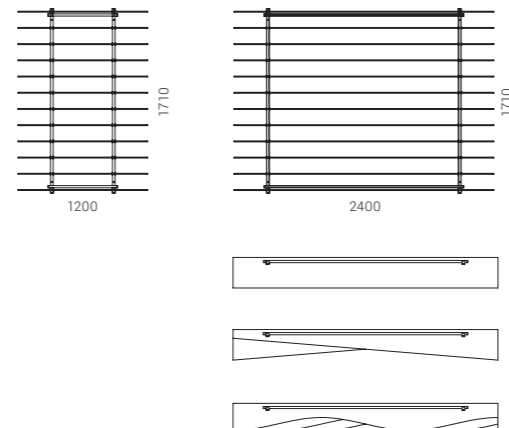

**ACOUSTIC ARTWORK** Ceiling

INTERIA DISTRIBUTED BY  
PT INTERIA REGALIA NUSANTARA  
hello@by-interia.com

**ACOUSTIC  
SCREENS &  
PANELS**

PET felt acoustic  
panels for ceiling

Available in two different shapes (round and rectangular) and a variety of colours and sizes, the panels not only improve the acoustics of a room but also "adapt" flexibly to the functional and aesthetic requirements of a given space, creating an attractive and modern interior design.



218

Sustainable design

PET felt acoustic products encourage responsible use of resources and waste reduction, as they are made from recycled materials and are also recyclable. These products feel similar to wool to the touch, but the PET felt is in fact made from plastic and uses more than 50 percent of recycled plastic.

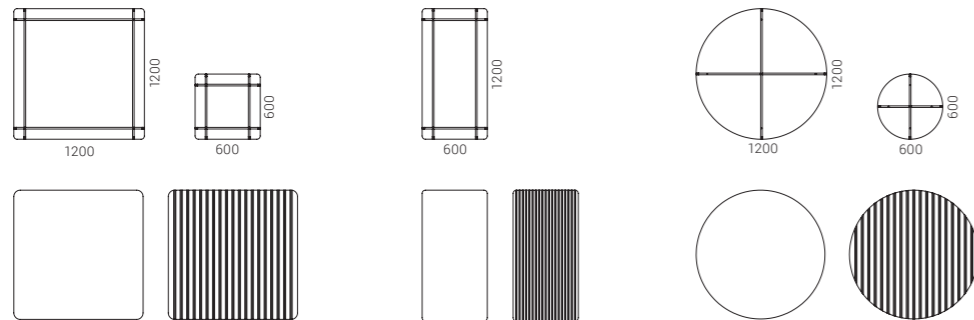

**ACOUSTIC ARTWORK** Ceiling



## PET felt tiles for suspended ceiling "Armstrong"

They are a functional acoustic solution for ceilings with a wide choice of colours and easy installation. Easily match a colour or colour combination to a specific interior design concept.



# ACOUSTIC ARTWORK Accessories

> 210

> 212

> 214

ACOUSTIC  
SCREENS &  
PANELS

For creating  
a comfortable  
workplace

The collection consists of PET felt free-standing desk screens and a PET felt basket.



The PET felt free-standing desk screen is a mobile, compact and stylish acoustic accessory for temporary workplaces or noisy and distracting spaces that prevent concentration.

221

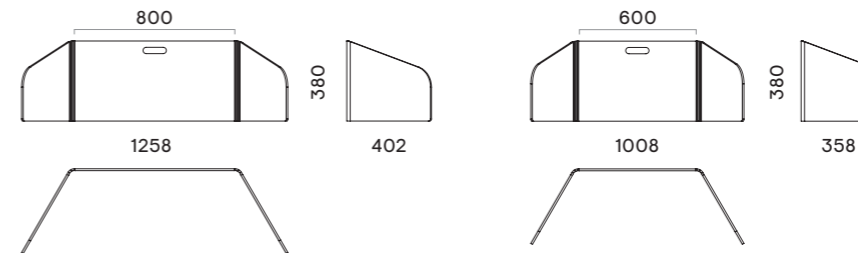

The design and colour range of PET felt baskets match PET felt free-standing desk screens. It is the perfect comprehensive solution for a functional and aesthetically pleasing temporary workplace with any type of desk.

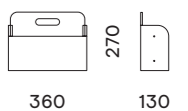

# ZEDO PET

Design by Paolo Pampanoni

ZEDO PET are exclusive acoustic screens which are integral part of a modern, aesthetic and comfortable workplace.

## Thoughtful design

Non-typical felt sheet bending totally hides its supporting structure, while the extended edge covers the cable tray and wires. This way a workplace looks neat and aesthetic.



222



## Fast assembly

Thanks to the ZEDO PET screen holders, you can assemble your screen quickly and easily, and disassemble and relocate if circumstances change.

ZEDO PET

## Playful accessories

A magnetic board and a shelf for small objects or plants can be attached to the screen if necessary. Functional metal accessories echo the colour combinations of the ZEDO desk system. Distinctive accessories add a unique and playful touch to your workplace. Also, they are a very suitable tool to personalize your workplace.

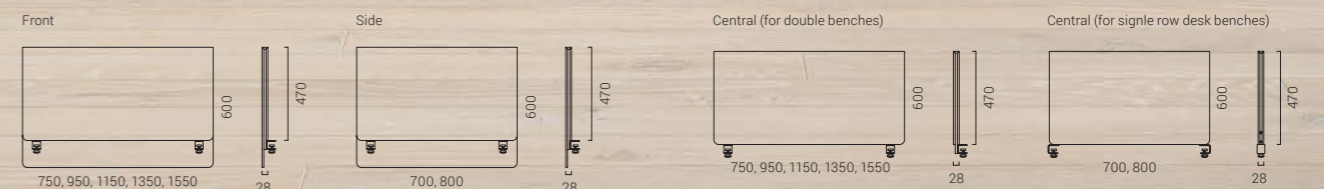

ZEDO PET

# ROUND PET

A sustainable solution for acoustic comfort and privacy

ROUND PET acoustic desk screens are an excellent solution to ensure a greater level of privacy and acoustic comfort for employees, while at the same time giving them sufficient freedom to share their ideas with other team members. The product encourages circular economy as it is made from recycled materials and it is also suitable for recycling.



224  
530 mm  
screen height above the desktop.



330 mm  
screen height above the desktop.

## PET felt features

This sustainable material possesses excellent sound absorption properties. PET felt is soft and light, yet strong and durable material is ideal for desk screens. Due to the structure PET felt can be easily cleaned and disinfected.

### SCREEN PATTERN TYPES

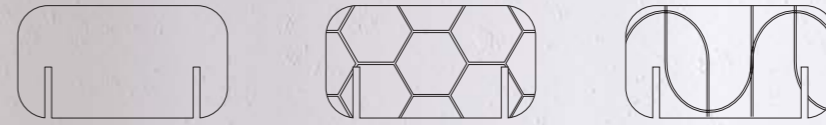

### SCREEN TYPES

For fixed desktops

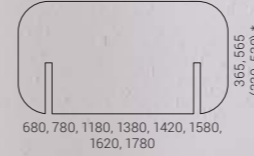

Mobile

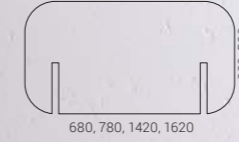

For sliding desktops

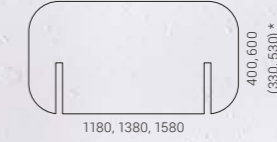

\* - screen height above the desktop

## Rounded design sequel

ROUND PET acoustic screens are a part of ROUND desk system. Therefore, they share the rounded shapes as the main design element.



PET felt  
BA10

**ACOUSTIC  
DESK  
SCREENS**



## Privacy and comfort at the workplace

Height-adjustable or fixed-height MODUS acoustic desk screens will offer both privacy and sound absorption sheltering users from general office noise.



228



MODUS

MODUS acoustic desk screens are double-sided. Thanks to this construction, you will be able to choose a combination of two different colours.

Height-adjustable screens will allow you to adjust the height of these acoustic screens by releasing and tightening the metal holders. Choosing a fixed-height will ensure a uniform look of the workspace even with one employee standing and another sitting at the desk.

The screens provide Class D sound absorption. Class C sound absorption is available for MODUS desk screens specifically designed for our MOTION two-desk benches.



Height adjustable screens suitable for desk systems:  
ACTIVE, single MOTION desks, single EASY desks, ONE, NOVA A, T-EASY, ONE H

Screens suitable for MOTION bench desks with leg columns type 2.  
515 mm - screen height above the desktop.

Screens suitable for MOTION bench desks with leg columns type 3.  
660 mm - screen height above the desktop.



MODUS

# DESK 760

## Privacy without isolation

The DESK 760 acoustic panel system improves visual and sound comfort of the workplace without separating team members from one another thus allows them to communicate freely. The system offers screens to cover all sides of the desk. Thanks to a wide range of colour options and functionality, these panels work well in various spaces.

230



DESK 760

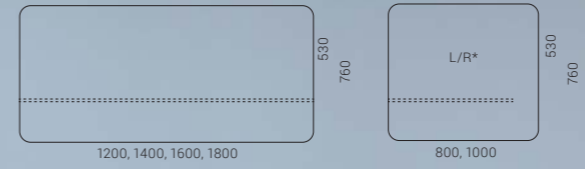

Screens suitable for desk systems:  
NOVA U, NOVA H, NOVA A, NOVA O, EASY,  
T-EASY, ONE, ACTIVE, AIR, NOVA Wood  
(Melamine; only single desks)

\* - left/right



DESK 760

## Acoustic comfort and privacy at the workplace

TOP 530 acoustic desk screens add privacy to your workplace and absorb background office noise. This solution enables employees to better focus on their tasks yet still allows communication and doesn't separate team members from one another. The system offers screens to cover all sides of the desk.

Because of the sound-absorbing material TOP 530 acoustic desk screens have a class C rating for sound absorption. The screens are perfect for both single desks and bench desks and come in a variety of colours and materials to match any interior.

232

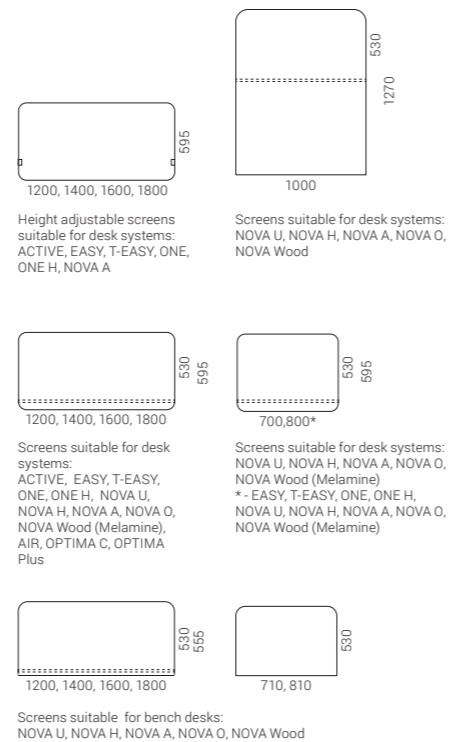
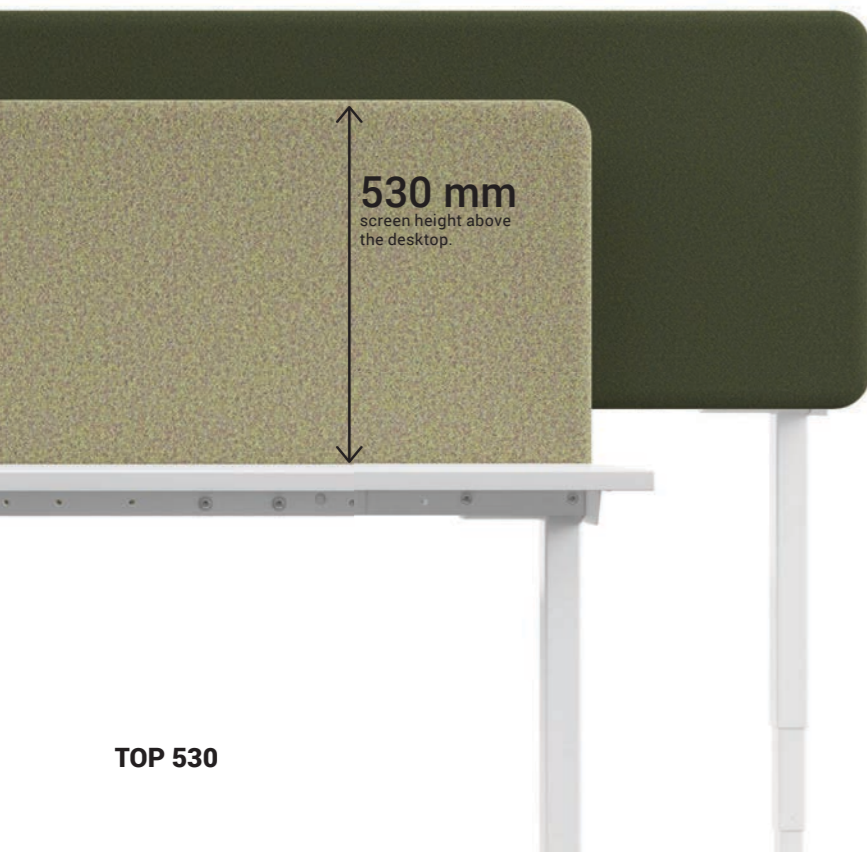

# PARTHOS



## Wide range of functional applications

The PARTHOS collection consists of four types of acoustic columns. By combining them with different NARBUTAS acoustic solutions, you can create acoustic comfort and a stylish environment for your employees.



234

## Ensured acoustic features

PARTHOS ensures that high-, medium- and low-frequency sounds are attenuated. It is covered with PET felt, which is porous and enhances these properties. The choice of pattern also contributes to the improvement of acoustics by dispersing some of the sound waves.

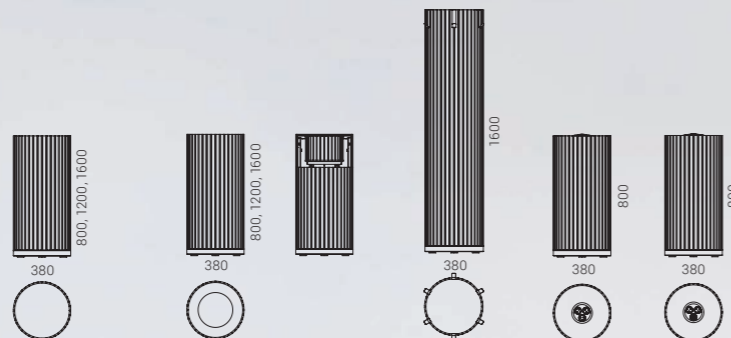

235



## Sustainable design

For the filling of the acoustic columns, we used textile offcuts left over from the manufacturing process. The acoustic columns are covered with PET felt made from more than 50% recycled plastic.

PET felt  
BA11

PET felt  
BA10

PET felt  
BA07

PET felt  
BA07

PET felt  
BA07

AUSTEA  
GT04

# JAZZ Silent Box

Design by Christina Strand and Niels Hvass

> 430  
MODULAR  
SYSTEMS  
AND POUFS



238

## A private and quiet space for meetings

JAZZ Silent Box is a quiet place of retreat in your office environment designed for meetings, brainstorming, individual work or relaxation. JAZZ Silent Box is made of special sound-absorbing material which delivers class D sound absorption.

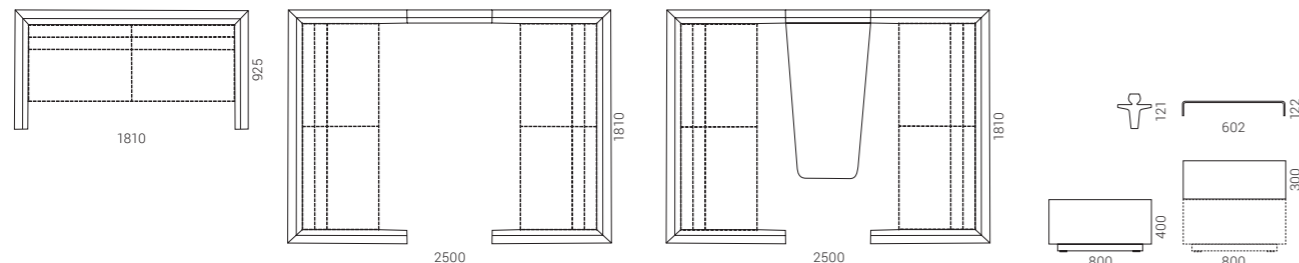

JAZZ Silent Box



SYNERGY  
GS08

Silent Box option with a table and a monitor holder will enable you to work on your computer conveniently and to display visual information on the screen during meetings. The furniture can also be equipped with a power outlet and a USB connection.

SYNERGY  
GS84

JAZZ Silent Box



SYNERGY  
GS17

SYNERGY  
GS16

Choose the acoustic walls of JAZZ Silent Box without the integrated soft furniture or table. Place your own customized combination of furniture within the acoustically pleasant and private environment of JAZZ Silent Box.

# MY SPACE

## Create your space with MY SPACE

From private mini-rooms for concentration to collaboration areas for teamwork, this system provides a comfortable workplace, allows you to distance yourself from ambient noise, and opens up new "office-within-office" possibilities.

242

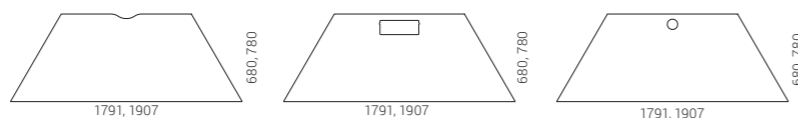

MY SPACE

## Proven acoustic characteristics

MY SPACE is a great choice to reduce the overall noise level of the office as the acoustic screens are filled with a special sound-absorbing foam and covered with upholstery of your choice.



MY SPACE

# Make your office stand out

Different size and shape desktops make MY SPACE a flexible solution for almost any working environment while height-adjustment function helps create a convenient workplace for individual tasks.

Thanks to the modular construction, this acoustic furniture allows you to electrify up to 6 workplaces with a single power socket. MY SPACE is available with a 3 socket power unit that can be used for standard power supply, USB, or LAN connection in different configurations.

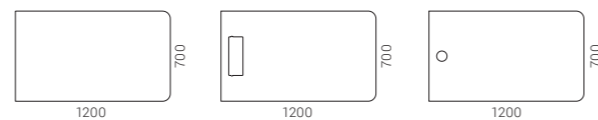
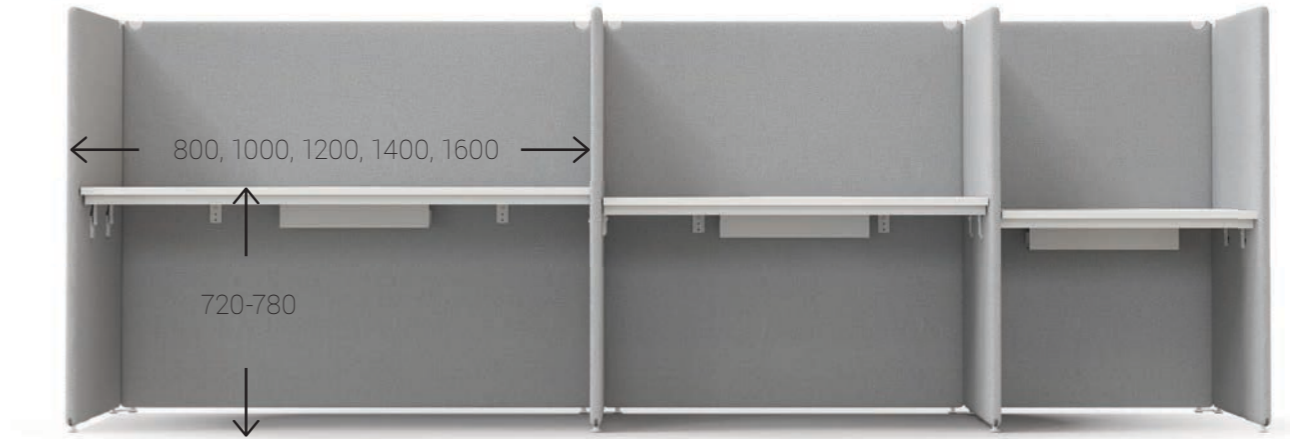
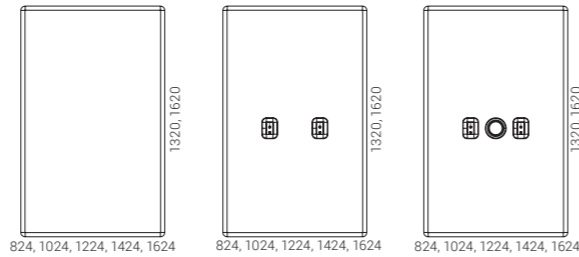

You can choose different interior and exterior colors for MY SPACE screens. Use your desired color combinations to create individual spaces or group workspaces.

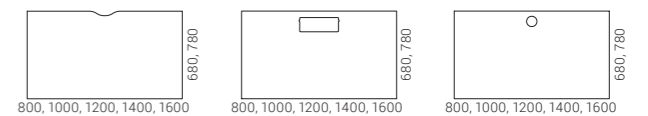



ACOUSTIC  
FURNITURE

# ARCIPELAGO Wood

Design by Baldanzi & Novelli designers

> 396  
SOFAS,  
LOUNGE  
CHAIRS,  
MODULAR  
SYSTEMS AND  
POUFS

## Escape busy office environment

ARCIPELAGO Wood lounge seating is ideal for creating an enclosed "room within a room" in open-plan offices. It serves as a meeting and work space where you can isolate yourself from ambient noise. This lounge seating is ideal for multiple uses: brief tasks or longer work sessions, meetings, teamwork or relaxation.

248



ARCIPELAGO Wood

## Design

ARCIPELAGO Wood has been designed by the Italian design studio Baldanzi & Novelli Designers. Aesthetic design, smooth shapes and natural elements bring a sense of warmth to the office.

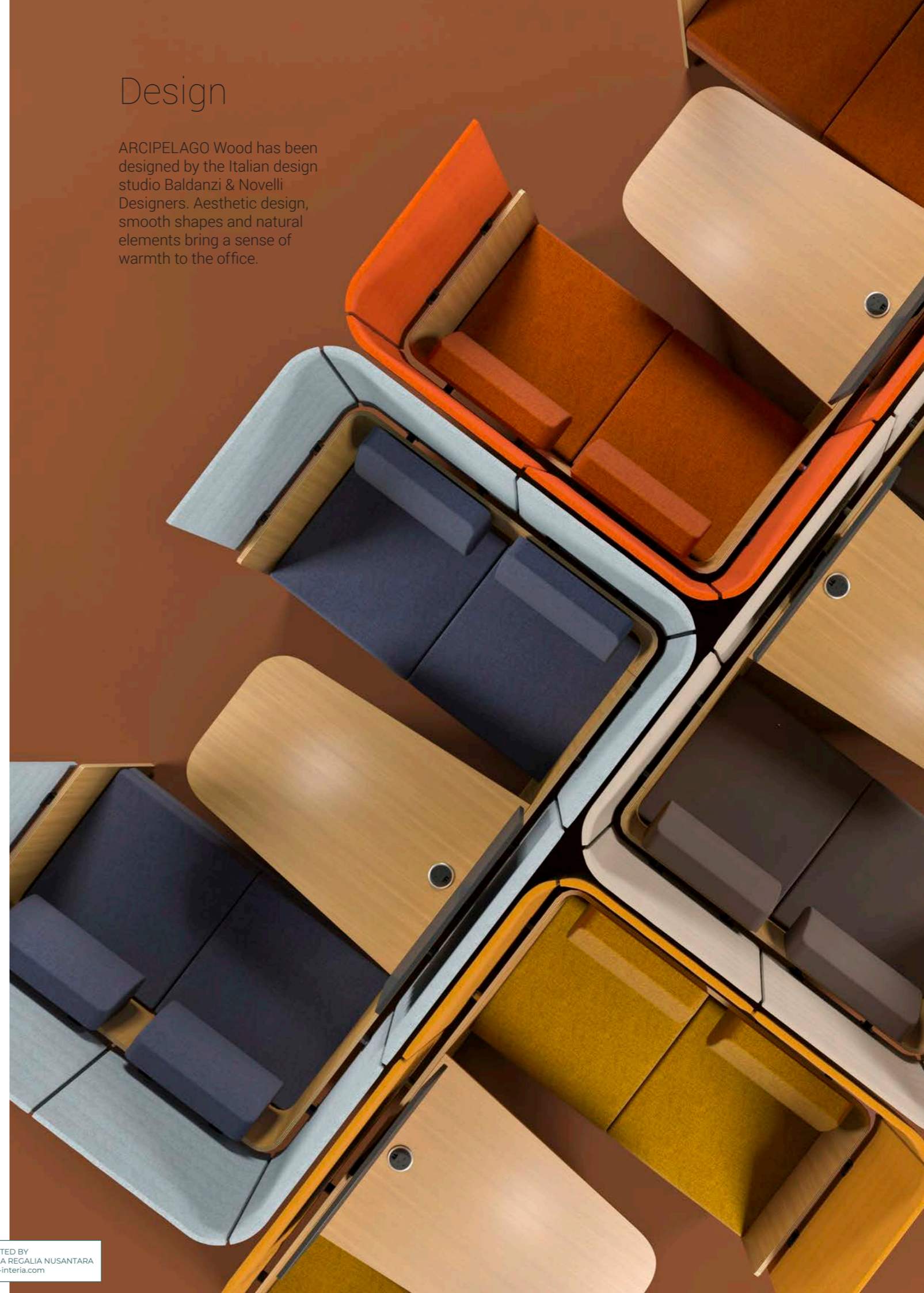



## Functionality

The seating unit can accommodate a monitor screen for convenient presentation of information during business meetings. The table is equipped with a power socket with integrated USB type A and C connectors for any work devices to make sure you never run out of energy.

251

## Comfort

Baldanzi & Novelli Designers who created ARCIPELAGO Wood compares this piece of furniture to an island which offers a natural retreat. ARCIPELAGO Wood high panels serve as barriers shielding employees from background noise while comfortable seating creates a laid-back and private environment.

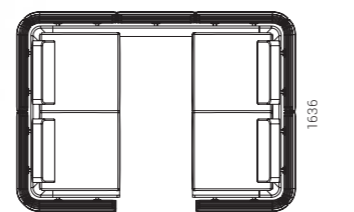

2276

1636

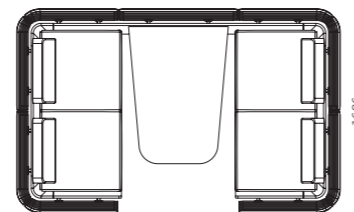

2596

1636

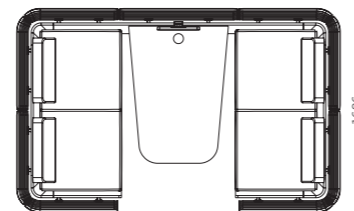

2596

1636



# CHAIRS

## TASK CHAIRS



D-CHAIR  
> 256



WIND  
> 278



MOON  
> 294



OFY  
> 262



NORTH CAPE  
> 284



DIVA  
> 296



SANDIE  
> 268



EVA  
> 288



AURA  
> 298



SURF  
> 272



EVA.II  
> 290

## HIGH SWIVEL CHAIRS



WOBBY  
> 300



WIND  
> 302

## EXECUTIVE CHAIRS



D-CHAIR  
> 304



AURA  
> 324



OFY  
> 308



EVA.II  
> 326



SANDIE  
> 314



NORTH CAPE  
> 318

252

253

# VISITOR, CONFERENCE & DINING CHAIRS



**D-CHAIR**  
> 328



**POLYTONE-C**  
> 352



**GAMA**  
> 366



**OFY**  
> 332



**POLYTONE-L**  
> 354



**EVA**  
> 368



**SANDIE**  
> 336



**POLYTONE-O**  
> 356



**AURA**  
> 370



**WIND**  
> 340



**MOON**  
> 358



**DIVA**  
> 371



**TWIST&SIT**  
> 344



**MOON Wood**  
> 362



**NORTH CAPE**  
> 346



**WAIT**  
> 364

# HIGH CHAIRS & STOOLS



**TWIST&SIT**  
> 372



**MOON Wood**  
> 378



**CANNIE**  
> 374



**WAIT**  
> 380



**POLYTONE-L**  
> 376



**MOON**  
> 378

# D-CHAIR

Design by Baldanzi & Novelli designers

> 304  
EXECUTIVE  
CHAIRS

> 328  
VISITOR,  
CONFERENCE  
& DINING  
CHAIRS



reddot winner 2024



256

## Seamless minimalist design

The seat merges gracefully with the backrest and is shaped to follow the curves of a sitting body. The elegant curve of the frame begins at the top and flows down to the sides in an ergonomic sinuosity.

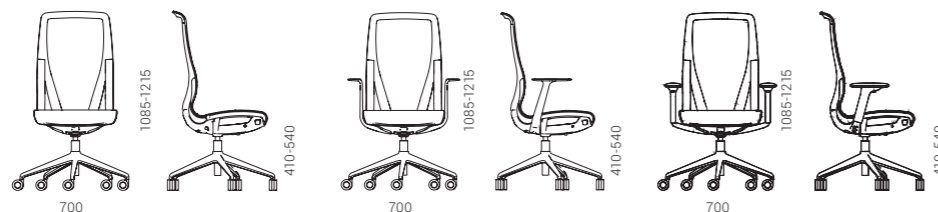

D-CHAIR

“

We wanted a linear, continuous and simple structure. We were inspired by herons flying lightly above the water and resting on it. We thought of bamboo reeds, so slender and so strong in the wind.

Baldanzi & Novelli designers



257

D-CHAIR

## TASK CHAIRS

Features that ensure a pleasant sitting experience

A variety of choices to create the desired image

The backrest, seat and synchro mechanism integrated into the chair work together to form a flexible structure for exceptional user comfort. You can also choose from non-adjustable armrests or 2D and even 4D adjustable ones.

Choose from three available chair frame colors, and explore six mesh colors carefully selected by the design team to perfectly reflect contemporary office trends. With this choice of plastic and mesh colours, you can create both colourful and monochromatic combinations.



## TASK CHAIRS



## Experience the sensation of lightness

D-CHAIR is a collection of chairs that harmoniously combines minimalist design with innovative engineering solutions. This collection consists of two types of chairs - an executive chair with a high backrest and a task chair with a lower backrest.

PET felt  
BA02

SS Mesh  
FW03

261

TASK  
CHAIRS

# OFY

Designer Alegre Design

> 308  
EXECUTIVE  
CHAIRS

> 332  
VISITOR,  
CONFERENCE  
& DINING  
CHAIRS

Exceptionally cosy  
design embracing  
office spaces

A well-designed and comfortable office chair is among the key elements contributing to a cosy office environment by prioritising the physical well-being and satisfaction of employees. OFY is a wide collection of chairs with an exceptionally cosy design that meets the needs of a modern employee in different office spaces. It consists of executive chairs, traditional and low-back task chairs and visitor chairs with a pyramid-shaped base with glides or castors.



262



OFY



“

*OFY stands for 'Only For You'. When designing the chair, we tried to ensure that it could be used by different companies in different architectural spaces and that each employee could have 'their own' chair.*

Alegre Design

**TASK  
CHAIRS**

Armrests with  
different designs  
and functionalities

A broad selection of armrests will make it easy to find the right solution for different workspaces. The two types of non-adjustable armrests have a graceful and elegant design. If you want to be able to adjust the armchairs to find the most comfortable position for your arms, you can choose between 1D (moves up/down) and 3D (moves up/down, forwards and backwards, sideways up to 30°) adjustable armrests.

Easy adjustment  
of the task chair

Each user can customise the chair to achieve the desired level of comfort. When designing this chair, we took into account what is most needed to feel comfortable when sitting for extended periods of time.

264



SYNCHRONOUS  
MECHANISM



WEIGHT-SENSITIVE  
MECHANISM



SEAT DEPTH  
ADJUSTMENT



ADJUSTABLE  
LUMBAR  
SUPPORT



LOCKING  
POSITIONS

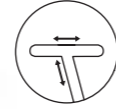

ADJUSTABLE  
ARMRESTS

OFY



265



OFY

TASK  
CHAIRS

TASK  
CHAIRS



AUSTEA  
GT04

AUSTEA  
GT02

OFY

OFY

INTERIA DISTRIBUTED BY  
PT INTERIA REGALIA NUSANTARA  
hello@by-interia.com

# SANDIE

Designed by "Baldanzi & Novelli designers"

> 314  
EXECUTIVE  
CHAIRS

> 336  
VISITOR,  
CONFERENCE  
& DINING  
CHAIRS

> 406  
LOUNGE  
CHAIRS

Where comfort  
reigns

As employees spend more and more time not only in their workplaces, but also in meeting and relaxation areas, modern offices are being designed and furnished with comfort and style. Introducing SANDIE, a collection of elegant furniture, designed to transform modern offices into stylish and comfortable spaces. It consists of high-back executive chairs, medium-back task chairs and low-back meeting chairs.

“

*SANDIE was inspired by the lightness of wind-shaped dunes. It is the result of an extensive process of aesthetic and functional exploration.*

Baldanzi & Novelli designers

268

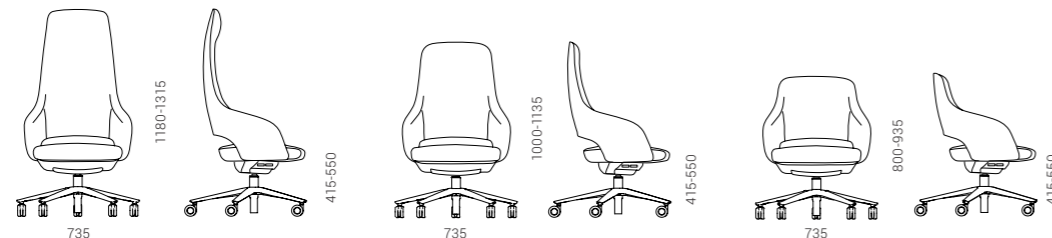

# Innovative synchronous mechanism

The new synchronous mechanism integrated in the task, executive and meeting chairs ensures seating comfort. The backrest can recline up to 18 degrees, while the seat moves up to 6 degrees, allowing the user to lean back without lifting their feet off the ground.



SYNCHRONOUS  
MECHANISM



LOCKING POSITIONS



PNEUMATIC HEIGHT  
REGULATION



270

SANDIE

# A set of elegant lines

There are no straight lines in SANDIE chairs, only soft and sleek curves that blend into an expressive whole. Every detail of the collection has been well thought out to achieve a dynamic yet subtle minimalist design.

PET felt  
BA11

CYBER  
GB12



SANDIE

# SURF

An excellent design and undeniable sitting comfort

When it comes to style and comfort there's no need for compromise. This chair offers it all. Its main distinctive feature is an appealing backrest silhouette resembling a windsurfing sail. The backrest and lumbar support were created by the German designer Justus Kolberg.



272

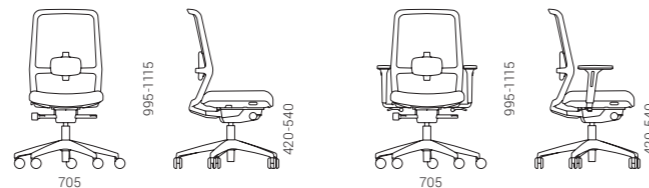

## Unique mesh

The mesh design combines functionality and aesthetics. It is a breathable, soft and light material with a special 3D structure. A wide mesh colour palette expands the possibilities of creating the perfect fit.



## Fine-tune your comfort level

SURF task chair provides great comfort and allows users to stay focused even after long hours of work.

274

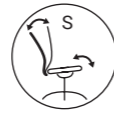

SYNCHRO  
MECHANISM



BACKREST TRAVEL  
LIMITATION



LOCKING  
POSITIONS



TENSION  
ADJUSTMENT



ADJUSTABLE  
LUMBAR SUPPORT

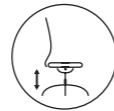

PNEUMATIC HEIGHT  
REGULATION

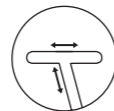

ADJUSTABLE  
ARMRESTS



TASK  
CHAIRS

BERTA  
GA12

BERTA  
GA11

BERTA  
GA12

RUNNER Mesh  
FR03

BERTA  
GA12

SURF

INTERIA  
DISTRIBUTED BY  
PT INTERIA REGALIA NUSANTARA  
hello@by-interia.com

# WIND

Design by Baldanzi & Novelli designers

> 302

HIGH  
SWIVEL  
CHAIRS

> 340

VISITOR,  
CONFERENCE  
& DINING  
CHAIRS

“

*We felt the need to give this product a decisive character – an element defining its identity. Thus, we came up with an idea to create a back support made from a transparent and flexible material and to make it an anthropomorphic shape instead of a technical shape which would be pleasing to the eye and as clear as the wind blowing onto the sails of a ship or making leaves tremble.*

Baldanzi & Novelli Designers

278



WIND



WIND

WIND family of chairs offers a combination of ergonomic features, functionality and unique design. Task chairs, high swivel chairs and visitor chairs designed for dynamic and efficient work and collaborative use are ideally suited for modern office spaces characterized by a unifying and unique WIND design.

280



**WIND**



## Unique lumbar support

WIND has an instantly recognizable X-shape transparent lumbar support uniquely designed to enhance the chair's visual appeal and serve a very important function. Its height can be adjusted and it conforms to the user's lumbar shape due to the elastic properties of silicone to provide exceptional comfort.

281



**WIND**

3 types of backrests

The backrest with a flexible mesh easily adapts to the natural shape of the user's spine. The aesthetic breathable mesh material ensures all-day comfort, no matter what seating position you use.



Micro-mesh

The mesh features a unique 3D structure which gives this chair a dynamic and distinctive look. This eye-catching and breathable fabric allows free circulation of air and helps prevent overheating. The soft and lightweight mesh adapts to the user's lumbar shape in order to keep the user comfortable throughout the day.



Runner mesh

The upholstered backrest is shaped with the principles of ergonomic seating in mind to ensure maximum workplace comfort. Its polyurethane insert with uniquely designed horizontal seams on both sides gives a totally different character to the chair. The backrest comes in a variety of upholstery options.



Fabric / leather look

Choose a backrest with a unique knitted mesh created by an Italian design studio Baldanzi & Novelli designers. The mesh design pattern follows the X shape to further enhance the lumbar support that creates the WIND chair's identity. The knitted mesh is made using cutting-edge technology which allows us to manufacture chairs with seamless backrest corners so no scrap material is left behind.



Knitted-mesh

Simple and intuitive adjustments

WIND encourages an ergonomically correct sitting position and provides the functionality you need. Thanks to its simple and intuitive adjustment, the chair can be easily adapted to individual user needs and offers maximum comfort for long stints at the desk.



SYNCHRONOUS MECHANISM



WEIGHT-SENSITIVE MECHANISM



SLIDE SEAT



LOCKING POSITIONS



ADJUSTABLE LUMBAR SUPPORT



HEADREST

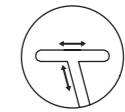

ADJUSTABLE ARMRESTS



# NORTH CAPE

Design by Baldanzi & Novelli designers

> 318  
EXECUTIVE  
CHAIRS

> 346  
VISITOR,  
CONFERENCE  
& DINING  
CHAIRS

## Stylish, modern and adaptable

NORTH CAPE design is a combination of simple but at the same time strict lines and soft curves. Rectangular armrests made of polyurethane fit the backrest harmoniously. Unique, laconic curve of the backrest fluently going down to the line of the seating part, creates a subtle silhouette of the chair, which has already become the identity of this chair.

284



KNEE TILT  
MECHANISM



TENSION  
ADJUSTMENT



LOCKING  
POSITIONS



“

*When two different cultures with the same goal meet, a wonderful result is achieved. The aim of the project was to create a chair, having an exceptional identity, which would combine and reveal Italian and Lithuanian styles.*

Baldanzi & Novelli designers

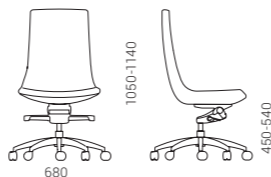
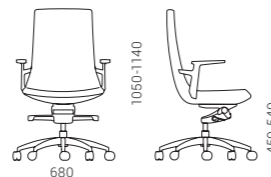

TASK  
CHAIRS

SYNERGY  
GS49



## Graceful style work chair

The chair's name EVA is a female name derived from the Hebrew name, meaning "life", may also have the meaning "lively". This is exactly what this task chair is, whose graceful shape is emphasized by the integrity of the backrest and seat.



288





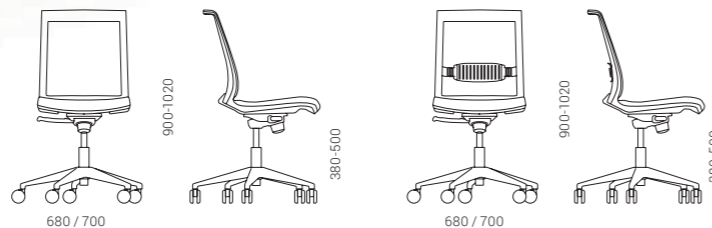

## Easy to feel comfortable

The back of the chair with a light, breathable polyester mesh adapts to the curves of the back and ensures comfortable support and constant air circulation. A stiffer plastic mesh for the back provides more support. The model with height-adjustable lumbar support - even better adapted to the shape of the user's back.



The EVA task chair has a tilting mechanism, it means that the backrest and the seat are connected, and when the backrest is reclined, the whole chair tilts. For the convenience of the user, the backrest can be locked in four different positions.



-  TILT MECHANISM
-  TENSION ADJUSTMENT
-  LOCKING POSITIONS
-  LUMBAR SUPPORT
-  ADJUSTABLE ARMRESTS

289

## Contemporary universal task chair

EVA.II's impetuous modern design, wide range of functionality and universal features make it a great choice for work environments both in the office and at home.



290



SYNCHRONOUS MECHANISM



TENSION ADJUSTMENT



LOCKING POSITIONS

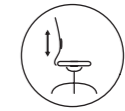

ADJUSTABLE LUMBAR SUPPORT

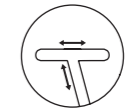

ADJUSTABLE ARMRESTS

## Comfortable backrest

The backrest with a light, porous polyester mesh moulds itself to the curvature of the user's back, ensuring comfort and constant airflow, while a firmer plastic mesh grants additional support. For a yet even better fit to the the shape of the user's back we recommend EVA.II with height-adjustable lumbar support.



291

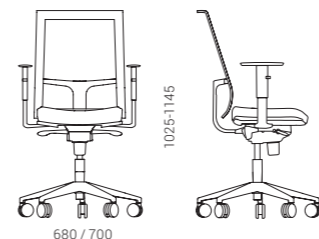

680 / 700

1025-1145

415-535

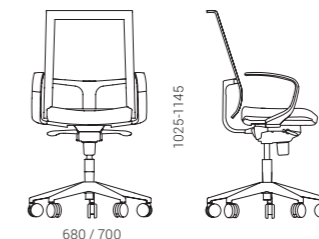

680 / 700

1025-1145

415-535

TASK  
CHAIRS

TASK  
CHAIRS



SYNERGY  
GS32

SYNERGY  
GS37

PET felt  
BA02

EVA.11

EVA.11

INTERIA  
DISTRIBUTED BY  
PT INTERIA REGALIA NUSANTARA  
hello@by-interia.com

TASK  
CHAIRS

# MOON

> 358  
VISITOR,  
CONFERENCE  
& DINING  
CHAIRS

> 378  
HIGH  
CHAIRS

MOON chair integrate perfectly into the modern office environment, in which does not dominate, but by choosing brighter color solutions – it may become a stylish interior accent.

294



## For a shorter working day

The user will be able to quickly and easily adjust the chair for a comfortable seat, and start work immediately.



TILT  
MECHANISM



TENSION  
ADJUSTMENT

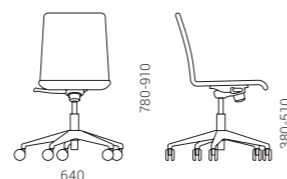

MOON



MOON

## Guaranteed ergonomics

The main goal of this ergonomic chair is to become an indispensable partner for the user during the working day, ensuring dynamic sitting positions, exceptional comfort, and ease of use.



296



The chair is available with either black polyamide or polished aluminum 5-star base with castors. Thanks to its simple and intuitive design, DIVA can be easily adapted to individual user needs.

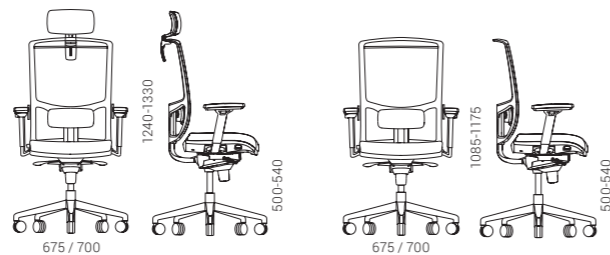

-  SYNCHRONOUS MECHANISM
-  TENSION ADJUSTMENT
-  BACKREST HEIGHT ADJUSTMENT
-  SLIDE SEAT
-  LOCKING POSITIONS
-  ADJUSTABLE LUMBAR SUPPORT
-  HEADREST
-  ADJUSTABLE ARMRESTS

297

# AURA

> 324  
EXECUTIVE  
CHAIRS

> 370  
VISITOR,  
CONFERENCE  
& DINING  
CHAIRS

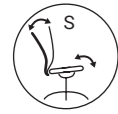

SYNCHRONOUS  
MECHANISM



TENSION  
ADJUSTMENT



LOCKING  
POSITIONS



SLIDE SEAT

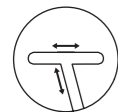

ADJUSTABLE  
ARMRESTS



AURA is designed to let you find a comfortable position for work as well as for relaxation. The seating part and the backrest are soft and give enough space to ensure comfort for a user.

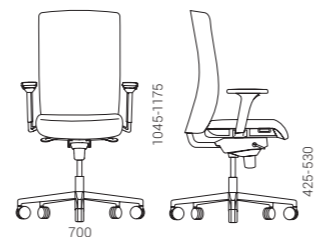

ERA  
GC02

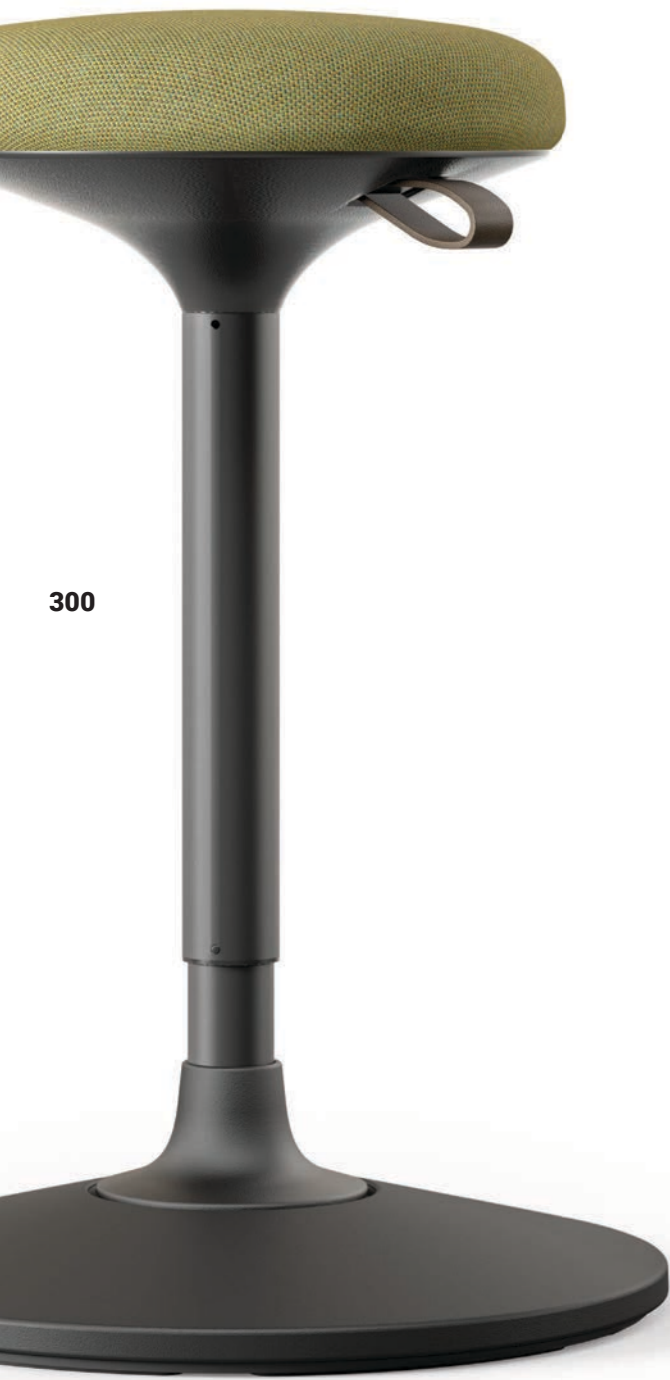

300

## Your best office partner

The WOBBY pivoting stool is a great choice for those looking for healthier sitting alternatives. It is a perfect active sitting solution for dynamic work and cooperation areas. The upper part of the stool swings and moves together with its user, so it can also be used as a support when standing. This allows you to change the position of the body at the workplace throughout the day without distracting from important tasks. Due to its modern and sleek design, this balance chair will fit into any contemporary office space.

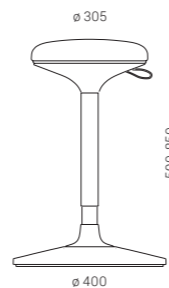

## A unique pivoting system

The distinctive feature of this chair is its unique pivoting system, hidden inside an elegant black plastic base. With the help of this system, the seat can be tilted up to 8 degrees in all directions and rotated 360 degrees. Having a non-skid surface, the base of the stool will always remain stable, while the high-quality materials will ensure safe and long-lasting use.

## Easy to use and safe

A pneumatic lift mechanism lets you fine-tune the perfect level for different work surface heights. The seat height can be adjusted from 600 mm to 850 mm with an elegant brown leather strap. Having a non-skid surface, the base of the stool will always remain stable, while the high-quality materials will ensure safe and long-lasting use.



301



## Dynamic and flexible work setting

The standards of ergonomic in modern office spaces are constantly changing, just as our understanding as to what work environment is best for the performance and well-being of office workers. One thing is clear: it is important to change one's body posture throughout the day and avoid staying in the same position for extended periods of time. WIND high task chair is great because it can be easily adapted to a variety of work settings, whether it is a sit-stand desk, a high desk or reception furniture.

## Keeping you comfortable and safe

With their soft, comfortably shaped seat and ergonomically designed mesh backrest, WIND chairs are comfortable to sit on even for long periods of time. Ring-shaped adjustable-height leg rest allows you to adjust the chair to your height, maintain a correct seating position and avoid unpleasant back and neck pain. The castors will provide extra safety and stability as they will be locked in place while you sit.

302



ADJUSTABLE LUMBAR SUPPORT

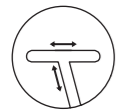

ADJUSTABLE ARMRESTS



PNEUMATIC HEIGHT REGULATION



FOOTRING HEIGHT ADJUSTMENT

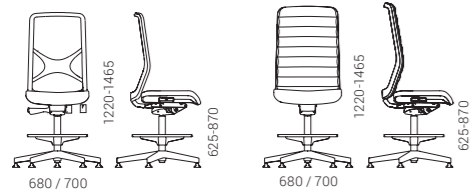

303



PNEUMATIC HEIGHT REGULATION

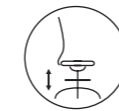

FOOTRING HEIGHT ADJUSTMENT

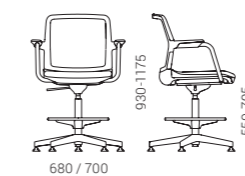
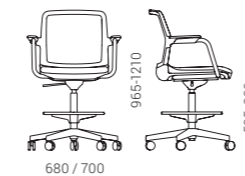

# D-CHAIR

Design by "Baldanzi & Novelli designers"

> 256

TASK  
CHAIRS

> 328

VISITOR,  
CONFERENCE  
& DINING  
CHAIRS

Minimalist design with  
innovative engineering  
solutions

All the details of the D-CHAIR chair not only create a modern aesthetic and a sensation of lightness, but also ensure the ultimate seating comfort. The professional product development team has meticulously designed every curve, rounded shapes, joints of the chair and thickness of its components, so that D-CHAIR ensures seating comfort and easy recline for the seated person.



reddot winner 2024

304

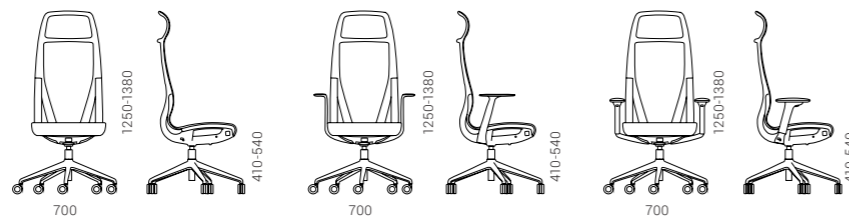

D-CHAIR



“

*The soft yet firm movement gives a pleasant sensation of lightness. Lean back and feel how naturally the chair adapts to your body's movements and weight – as if it were a living organism.*

Baldanzi & Novelli designers

D-CHAIR

## Headrest for even more comfort

The D-CHAIR executive chair with a high backrest has an integrated headrest. This additional part of the executive chair helps to relieve the neck tension and provides support and comfort for the head and neck when leaning back. The headrest is recommended for people who work in a sitting position for long periods. In addition, you can easily move the chair from one place to another by holding it by its upper frame.

In addition, you can choose a height-adjustable lumbar support with a smooth range of motion of 100 mm. It is made of a flexible PET plastic material that adapts well and gives your back even more support and comfort. This is particularly important when we spend long hours sitting.

306

## Transparent continuous mesh adds lightness to the design

The backrest and seat of the chair are made of a continuous mesh that is transparent. This gives the chair a sense of lightness and emphasises the beauty of its structure.



## All the parts of the chair come together to form a unique, indivisible unity

The professional product development team has meticulously designed every curve, rounded shapes, joints of the chair and thickness of its components. The seamless seat monoblock is made up of many different yet interacting parts that come together to form an indivisible unity, creating an innovative design. This is the main feature of D-CHAIR that makes it so unique and guarantees maximum sitting comfort.



SYNCHRONOUS  
MECHANISM



WEIGHT-SENSITIVE  
MECHANISM



TENSION ADJUSTMENT



LOCKING POSITIONS



PNEUMATIC HEIGHT  
REGULATION

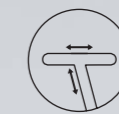

ADJUSTABLE ARMRESTS



HEADREST

# OFY

Designer Alegre Design

> 262

TASK  
CHAIRS

> 332

VISITOR,  
CONFERENCE  
& DINING  
CHAIRS



308

Concept inspired  
by the resimericial  
design trend

People want their workplace to feel like home, which is why resimericial design, combining two concepts: residential and commercial, is becoming popular in offices. OFY successfully bridges this gap and creates a cosy environment that responds to changing workplace design preferences and improves the overall well-being and productivity of employees. With its delicate, soft shapes, cosy upholstery and excellent ergonomic qualities, the chair collection perfectly reflects this trend.



OFY



OFY

## EXECUTIVE CHAIRS

### Meeting the most important ergonomic needs

OFY is more than just a chair with a distinctive design, easily adaptable to different interiors. It has all the essential features to meet today's ergonomic needs.



SYNCHRONOUS  
MECHANISM



WEIGHT-  
SENSITIVE  
MECHANISM



SEAT DEPTH  
ADJUSTMENT

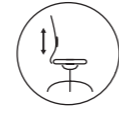

ADJUSTABLE  
LUMBAR  
SUPPORT



LOCKING  
POSITIONS

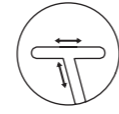

ADJUSTABLE  
ARMRESTS

### Cosiness through synthesis of design elements

Every detail has been chosen to contribute to a feeling of cosiness. Unlike most of our office chairs, OFY does not use a mesh for the backrest. The synthesis of the upholstered backrest and the soft, rounded-shape seat creates a sense of cosiness.

310



OFY

311



OFY

EXECUTIVE  
CHAIRS

EXECUTIVE  
CHAIRS

CYBER  
GB13

CYBER  
GB04

OFY

INTERIA  
DISTRIBUTED BY  
PT INTERIA REGALIA NUSANTARA  
hello@by-interia.com



# SANDIE

Designers „Baldanzi & Novelli designers“

> 268

TASK  
CHAIRS

> 336

VISITOR,  
CONFERENCE  
& DINING  
CHAIRS

> 406

LOUNGE  
CHAIRS

Exceptional  
design and  
comfort

Executive office shapes the image of the whole company. This space is held to the highest standards of comfort and representativeness, which is why the right choice of furniture is so important. The SANDIE collection has been designed with particular attention to design and comfort, ensuring that each product not only looks sophisticated, but also allows the user to relax and feel comfortable.



314

Integrated  
armrests create  
an image of  
gravitas

The armrests of the furniture subtly merge with the backrest, seeming to embrace the user from behind. The continuous surfaces in SANDIE's design not only create an image of gravitas, but also emphasise the elegant lines that add luxury to the chairs.

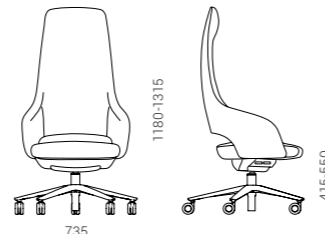

SANDIE

Features for  
your well-being

An innovative synchronous mechanism allows the seamless backrest and seat with integrated armrests to move in unison. The backrest can recline up to 18 degrees, and the seat up to 6 degrees, enabling the user to recline without lifting their feet off the ground, ensuring an ergonomic sitting position. In an executive office, where long working hours and important meetings demand exceptional comfort, these functionalities help maintain productivity and well-being.



315

SANDIE

EXECUTIVE  
CHAIRS

PET felt  
BA02

AUSTEA  
GT01

AUSTEA  
GT03

316

317

SANDIE

SANDIE

INTERIA  
DISTRIBUTED BY  
PT INTERIA REGALIA NUSANTARA  
hello@by-interia.com

EXECUTIVE  
CHAIRS

# NORTH CAPE

Design by Baldanzi & Novelli designers

> 284  
TASK  
CHAIRS

> 346  
VISITOR,  
CONFERENCE  
& DINING  
CHAIRS

In harmony with modern  
elegance and comfort

Creating the manager's office using these chairs, you will  
ensure not only a stylish workplace but also comfort.



reddot winner 2021  
office design

318

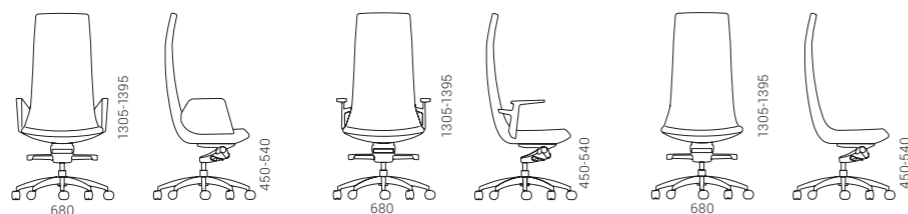

NORTH CAPE

INTERIA DISTRIBUTED BY  
PT INTERIA REGALIA NUSANTARA  
hello@by-interia.com

EXECUTIVE  
CHAIRS



NORTH CAPE

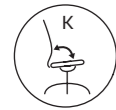

KNEE-TILT  
MECHANISM



TENSION  
ADJUSTMENT



LOCKING  
POSITIONS

## Create different images

In order to accomplish desired style for the executive office, you can choose from 2 models: laconic, simple but elegant design or much more sophisticated silhouette with a bigger backrest, softer seating pad and unique pattern of horizontal stitching lines.

320

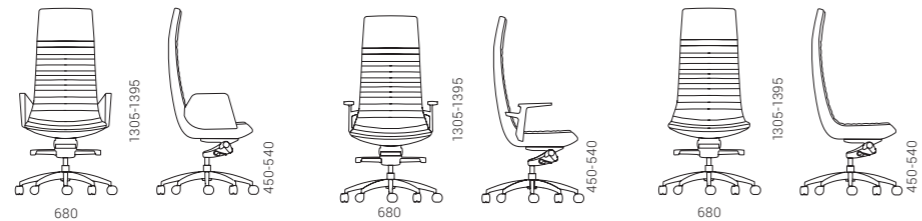

EXECUTIVE  
CHAIRS



NORTH CAPE

INTERIA  
DISTRIBUTED BY  
PT INTERIA REGALIA NUSANTARA  
hello@by-interia.com

NORTH CAPE

# AURA

> 298

TASK  
CHAIRS

> 370

VISITOR,  
CONFERENCE  
& DINING  
CHAIRS

Good aura at work is  
essential just like air

Aura chair harmoniously combines timeless, universal  
design and comfort, which is ensured by ergonomic  
functions of the chair and spacious seating part.

324

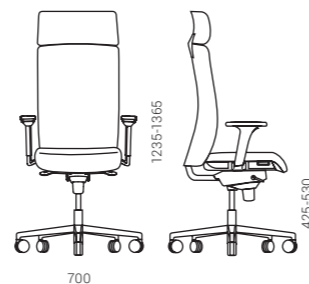

AURA



325

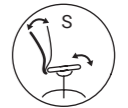

SYNCHRONOUS  
MECHANISM



TENSION  
ADJUSTMENT



SLIDE SEAT



LOCKING  
POSITIONS



HEADREST

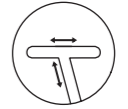

ADJUSTABLE  
ARMRESTS

AURA

## Universal task chair for executives

EVA.II's impetuous modern design, wide range of functionality and universal features make it a great choice for work environments both in the office and at home. This chair can easily be adjusted to suit various different needs.

326



## Comfortable back and head rests

The backrest with a light, porous polyester mesh moulds itself to the curvature of the user's back, ensuring comfort and constant airflow, while a firmer plastic mesh grants additional support. The executive chair variant also has a soft polyurethane headrest, which helps reduce neck muscle tension during long work hours.

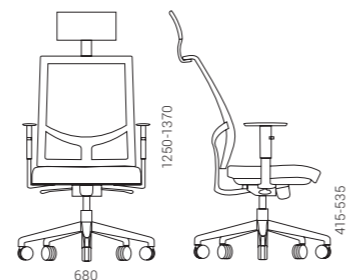

## Different variations and images

Design EVA.II according to your own preference by choosing between the various frame, mesh and seat colour, as well as base options.



SYNCHRONOUS  
MECHANISM



TENSION  
ADJUSTMENT



LOCKING  
POSITIONS

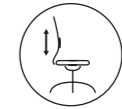

ADJUSTABLE  
LUMBAR SUPPORT



HEADREST

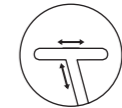

ADJUSTABLE  
ARMRESTS

327



VISITOR,  
CONFERENCE  
& DINING  
CHAIRS

# D-CHAIR

Designed by "Baldanzi & Novelli designers"

> 256  
TASK  
CHAIRS

> 304  
EXECUTIVE  
CHAIRS

Sit back, close your eyes  
and let yourself be lulled  
by the sensations the  
chair creates

The chair's continuous silhouette and  
subtly integrated adjustment mechanism  
create a feeling of exceptional lightness.



reddot winner 2024

328

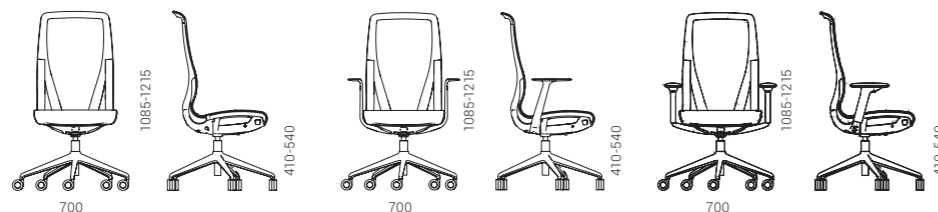

D-CHAIR

INTERIA DISTRIBUTED BY  
PT INTERIA REGALIA NUSANTARA  
hello@by-interia.com

VISITOR,  
CONFERENCE  
& DINING  
CHAIRS



SYNCHRONOUS MECHANISM



WEIGHT-SENSITIVE MECHANISM



TENSION ADJUSTMENT



LOCKING POSITIONS



PNEUMATIC HEIGHT REGULATION

## Two types of chairs

This collection consists of two types of  
chairs - an executive chair with a high back-  
rest and a task chair with a lower backrest,  
which can also be a comfortable choice for  
meeting spaces. The chairs in the D-CHAIR  
collection can be easily used in a variety of  
modern office spaces while maintaining a  
stylish overall look.



D-CHAIR

VISITOR,  
CONFERENCE  
& DINING  
CHAIRS

PET felt  
BA01

SS MESH  
FW08

330

331



D-CHAIR

D-CHAIR

INTERIA  
DISTRIBUTED BY  
PT INTERIA REGALIA NUSANTARA  
hello@by-interia.com

VISITOR,  
CONFERENCE  
& DINING  
CHAIRS

# OFY

Designer Alegre Design

> 262

TASK  
CHAIRS

> 308

EXECUTIVE  
CHAIRS

VISITOR,  
CONFERENCE  
& DINING  
CHAIRS

Recognisable  
collection thanks  
to its unique  
backrest frame

All chairs in the OFY collection share a sculptural backrest frame that seems to embrace the chair from behind. This makes them easy to mix and match in different spaces while maintaining a consistent style. The frame of the OFY chair comes in two colours: black and grey. It can be paired with a base of the same colour, along with integrated or fixed armrests boasting a graceful and elegant design.



332

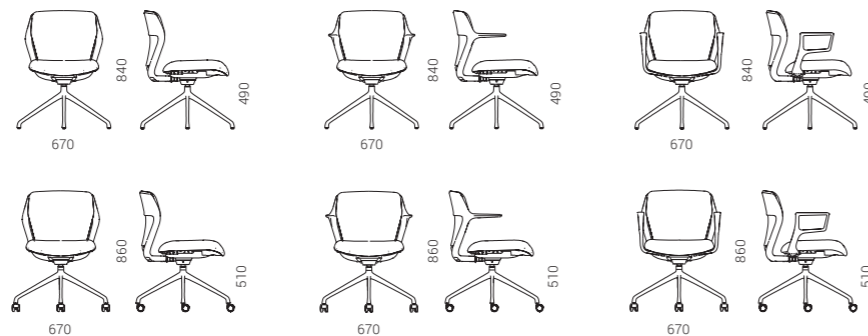

OFY

Prioritising health  
and comfort

Although we usually spend less time in visitor chairs than in task chairs, we made sure that you will be just as comfortable when you do. The OFY visitor and conference chairs have a built-in tilt mechanism that allows the user to sway gently and feel more relaxed.



333

OFY

The chair that flows through any space

Available in three heights, the chairs can be mixed and matched in a variety of workspaces and meeting spaces. The OFY chairs are ideal for team workplaces in open-plan offices, as well as in smaller, boutique-style offices and executive workspaces.

334

AUSTEA  
GT07

AUSTEA  
GT08

AUSTEA  
GT04

335

OFY

OFY

VISITOR,  
CONFERENCE  
& DINING  
CHAIRS

# SANDIE

Designed by "Baldanzi & Novelli designers"

> 268

TASK  
CHAIRS

> 314

EXECUTIVE  
CHAIRS

> 406

LOUNGE  
CHAIRS

VISITOR,  
CONFERENCE  
& DINING  
CHAIRS

“

*Our goal was to create comfort that conveys elegance with just a glance at the furniture.*

Baldanzi & Novelli designers



336

## Combining chairs in different spaces

SANDIE chairs feature a distinctive lightweight design, making them versatile for use in various office spaces. By incorporating chairs of three different heights in meeting, work, and executive areas, they help create an aesthetically cohesive office that ensures comfort for both employees and guests.



SYNCHRONOUS MECHANISM



LOCKING POSITIONS

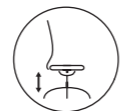

PNEUMATIC HEIGHT REGULATION



SANDIE

## The backrest design that unites the collection

SANDIE's visual identity is defined by its unique backrest, which is separate from the seat and gives the collection an expressive and modern look. This design solution creates a feeling of lightness, making the backrest the main accent that attracts attention and enhances the uniqueness of the collection.

## Innovative synchronous mechanism

As hybrid working model becomes more popular, employees move around the office daily, spending increasing amounts of time in various meetings. In such situations, we want to feel comfortable, as our well-being and productivity are directly influenced by it. The new synchronous mechanism integrated into SANDIE chairs ensures comfortable sitting. The backrest and seat tilt simultaneously up to 18 degrees and 6 degrees respectively, allowing the user to lean back without lifting their feet off the floor.



SANDIE



CYBER  
GB15

## Continuous yet distinctive design

One of the main features is its uniform design including the structure of the back and armrests as well as the upholstered seat.

Blends in any office  
environment



4-legs

4-star

Cantilever

5-star

340



341



STACKABLE

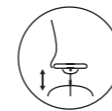

PNEUMATIC HEIGHT  
REGULATION

WIND visitor chairs are extremely versatile and perfectly suited for meeting, conference or reception areas. These chairs come in four different base options which can be easily adapted to a variety of office settings.

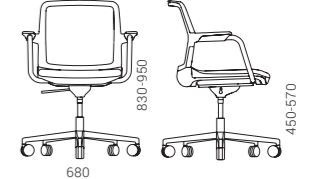
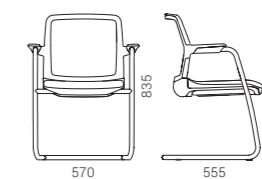
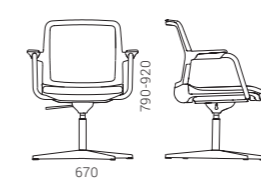
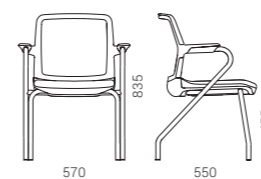

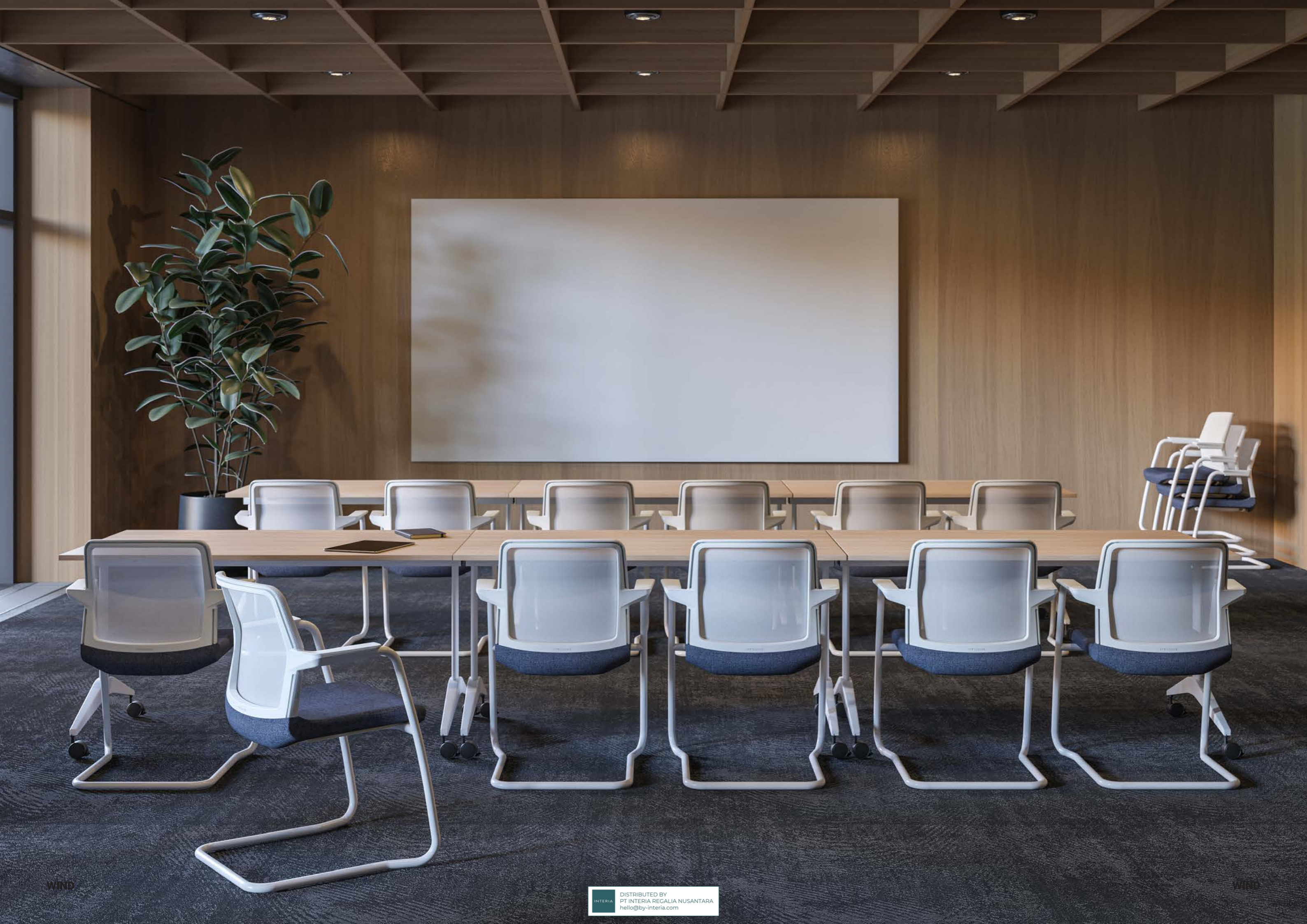

VISITOR,  
CONFERENCE  
& DINING  
CHAIRS

# TWIST&SIT

Design by Christina Strand and Niels Hvass

> 372

HIGH  
CHAIRS

> 392

SOFAS

> 416

> 418

LOUNGE CHAIRS

> 424

ARMCHAIRS



STACKABLE



344

Distinctive character and freedom of expression for your style

These chairs can be adapted based on the desired interior style as you can choose between industrial style metal legs and Scandinavian style wooden legs. The curved shell and ergonomic seating position makes collaboration process even more comfortable.

The TWIST&SIT chair can be used on its own or in large groups that look great in any space either it's a reception, conference hall or a meeting room.

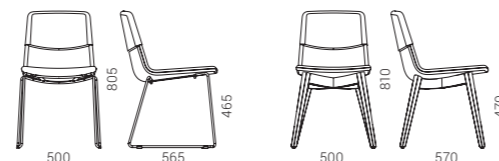

TWIST&SIT

INTERIA DISTRIBUTED BY  
PT INTERIA REGALIA NUSANTARA  
hello@by-interia.com

VISITOR,  
CONFERENCE  
& DINING  
CHAIRS

“

*Elegant and divided back enlarges the comfort of the chairs and at the same time the chair has a strong iconic expression.*

Christina Strand and Niels Hvass



VALENCIA C5  
DV04

PET felt  
BA11

VALENCIA C5  
DV02

TWIST&SIT

VISITOR,  
CONFERENCE  
& DINING  
CHAIRS

# NORTH CAPE

Design by Baldanzi & Novelli designers

> 284  
TASK  
CHAIRS

> 318  
EXECUTIVE  
CHAIRS

NORTH CAPE chairs are refined and stylish, thus can perfectly represent company in meeting and guest areas.

VISITOR,  
CONFERENCE  
& DINING  
CHAIRS

2 sizes for  
different needs

Chairs with lower backrests do not have armrests and are perfect for sitting comfortably in waiting or smaller meetings areas. Conference chairs with the same seating part proportions and armrests like those of task chairs are suitable for more spacious meetings rooms, where longer, more important and likely representative meetings take place.



A choice from  
4 bases



346



347

There are four options for NORTH CAPE visitor chair base, which suit different needs and office areas. Swivel, 4-leg base in polished aluminium provides elegance and sophistication. Chairs with cantilever base or 4-leg base are convenient for smaller, cosier meeting areas.

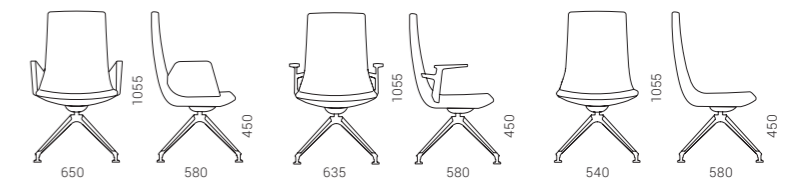
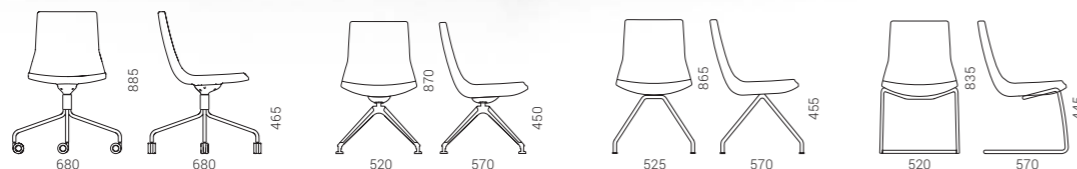

NORTH CAPE

NORTH CAPE

INTERIA DISTRIBUTED BY  
PT INTERIA REGALIA NUSANTARA  
hello@by-interia.com

VISITOR,  
CONFERENCE  
& DINING  
CHAIRS

VISITOR,  
CONFERENCE  
& DINING  
CHAIRS

PET felt  
BA11

CYBER  
GB12

348

349

NORTH CAPE

NORTH CAPE

INTERIA  
DISTRIBUTED BY  
PT INTERIA REGALIA NUSANTARA  
hello@by-interia.com

VISITOR,  
CONFERENCE  
& DINING  
CHAIRS

# POLYTONE

> 352

> 354

> 356

VISITOR,  
CONFERENCE &  
DINING CHAIRS

> 376

HIGH  
CHAIRS

The modern  
rhythm of  
work

A modern work environment – is more than just a comfortable and ergonomic personal workstation. It encompasses a wide range of different activities which revolve around a practical, functional and stylish chair. POLYTONE collection consists of three types of visitor, conference and dining chairs made of plastic: POLYTONE-C, POLYTONE-L and POLYTONE-O.

Practical  
and durable  
material

POLYTONE chairs are made of premium-grade polypropylene plastic. Plastic is one of the most versatile materials which is appreciated not only for its affordable price but also for easy maintenance and durability.

350



VISITOR,  
CONFERENCE  
& DINING  
CHAIRS

POLYTONE

VISITOR,  
CONFERENCE  
& DINING  
CHAIRS

# POLYTONE-C

Design by Sandonà and Sabrina Bettini

> 354

> 356

VISITOR,  
CONFERENCE &  
DINING CHAIRS

> 376

HIGH  
CHAIRS

Timeless modern  
classics

These chairs embody modern classics with timeless elegance. They add a lively and warm feel both to formal meeting spaces or informal relaxation areas.

Three types of bases  
for different needs

352

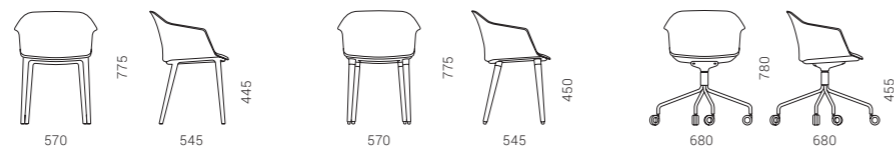

POLYTONE-C

INTERIA  
DISTRIBUTED BY  
PT INTERIA REGALIA NUSANTARA  
hello@by-interia.com

POLYTONE-C



**VISITOR,  
CONFERENCE  
& DINING  
CHAIRS**

# POLYTONE-L

Design by Scagnellato and Ferrarese Design

> 352

> 356

VISITOR,  
CONFERENCE &  
DINING CHAIRS

> 376

HIGH  
CHAIRS



**VISITOR,  
CONFERENCE  
& DINING  
CHAIRS**



354

Subtle minimalist  
design

Visitor, conference and dining chairs  
boast a subtle minimalist design, and a  
wide range of bases and height options  
allows for the simple arrangement of  
large interior spaces.



STACKABLE



WRITING TABLET



CONNECTORS

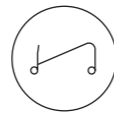

TROLLEY

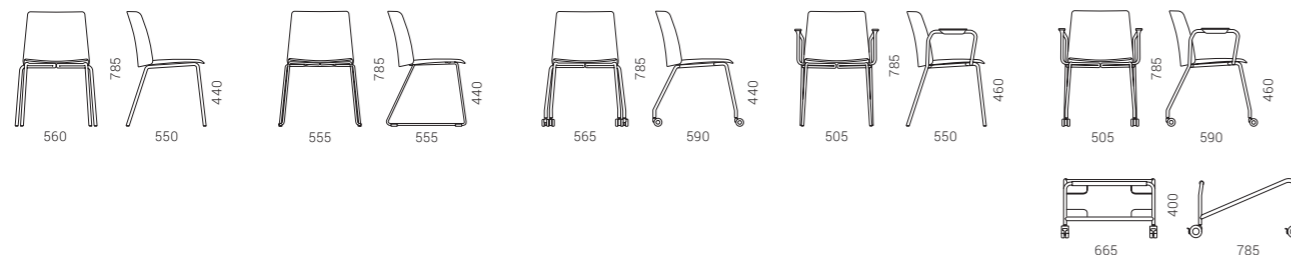

**POLYTONE-L**

INTERIA DISTRIBUTED BY  
PT INTERIA REGALIA NUSANTARA  
hello@by-interia.com

**POLYTONE-L**

VISITOR,  
CONFERENCE  
& DINING  
CHAIRS

# POLYTONE-0

Design by Orlandini Design

> 352

> 354

VISITOR,  
CONFERENCE &  
DINING CHAIRS

> 376

HIGH  
CHAIRS

A stylish office for  
any weather

These 100% plastic compact chairs featuring thin lines and ergonomic shape will look stylish both in indoor and outdoor spaces. It is a very versatile choice in terms of both use and maintenance.



reddot award 2017  
winner



356

## Recycled plastic

We continue to contribute to the creation of sustainable projects offering the chair versions in black and light grey colours made from 100% recycled plastic – a mixture of reused materials, such as industrial and consumer waste.



STACKABLE

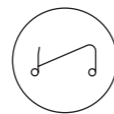

TROLLEY

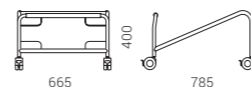
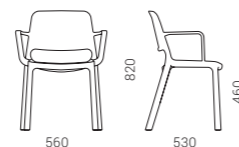
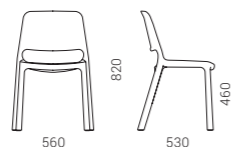

POLYTONE-0

INTERIA DISTRIBUTED BY  
PT INTERIA REGALIA NUSANTARA  
hello@by-interia.com

VISITOR,  
CONFERENCE  
& DINING  
CHAIRS



POLYTONE-0

Conference chairs  
with a light, minimalist  
silhouette

Participants in every  
conference

Because of their simple construction, MOON visitor chairs are very convenient for conference and training rooms. It is easy to arrange them in orderly rows by using connectors.

358



359

Bases of three types

There are three different steel bases available for MOON conference chairs: traditional 4-leg, base with castors or elegant sled frame which is made of very thin and elegant lines. The sled base has plastic glides which help to move the chair very easily without any damage to the floor.

Being compact and easily stackable (up to 5 chairs), they save your storage space and are convenient for transportation. Also, for user's convenience, it is possible to add a rotatable writing tablet, which can be fixed to a chair with armrests.



STACKABLE



WRITING TABLE



CONNECTORS

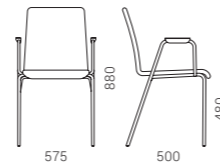
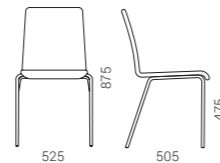
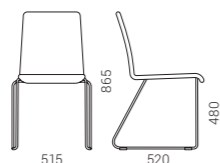
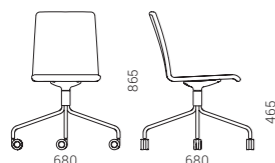

VISITOR,  
CONFERENCE  
& DINING  
CHAIRS

VISITOR,  
CONFERENCE  
& DINING  
CHAIRS

CYBER  
GB03

MOON

MOON

INTERIA DISTRIBUTED BY  
PT INTERIA REGALIA NUSANTARA  
hello@by-interia.com

VISITOR,  
CONFERENCE  
& DINING  
CHAIRS

# MOON Wood

> 378  
HIGH  
CHAIRS

VISITOR,  
CONFERENCE  
& DINING  
CHAIRS



STACKABLE



WRITING TABLE



CONNECTORS

Work breaks  
without any  
worries

Monobloc unit of the backrest and the seating part is made of plywood. Because of high quality materials, MOON Wood visitor chairs are perfect for office areas in which employees take some rest, eat or simply have a coffee break. Don't worry if your chairs get dirty, as the surface can be cleaned easily.

362

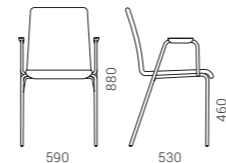
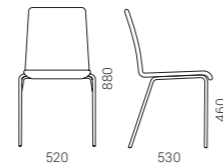
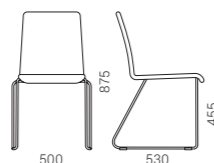

MOON Wood

INTERIA DISTRIBUTED BY  
PT INTERIA REGALIA NUSANTARA  
hello@by-interia.com



Playfulness in  
the office

They are modern, practical, and light, but at the same time durable, so they are perfect for conference and training halls, office spaces where visitors are received or where you can eat and relax.



364



Choose from a range of different colors of plastic and tapestries and you will definitely fulfill any interior.



STACKABLE



WRITING TABLE



CONNECTORS

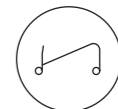

TROLLEY

365

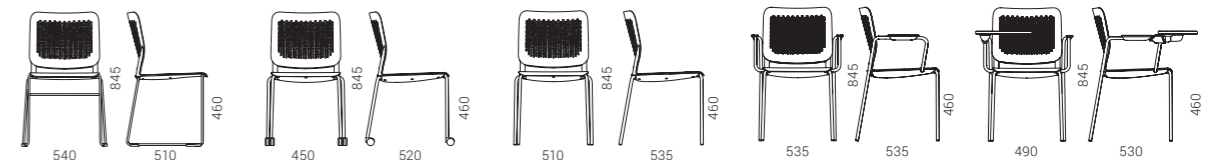
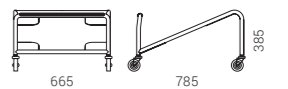

VISITOR,  
CONFERENCE  
& DINING  
CHAIRS

# GAMA

Any place, any time

It was created for those who appreciate comfort, easy-to-adapt style, and functionality.



366

Different features  
for different needs



STACKABLE

There are three different steel bases available for GAMA chair system: a traditional 4-leg base, a cantilever frame base, and a 4-leg base with castors for an easier movement in spaces. All bases can be either chromed or powder-coated (metallic or black).

The backrest of the chair can be upholstered with either fabric or mesh.

Being stackable, (up to 6 chairs) these chairs are easy to transport and can optimize the room space.

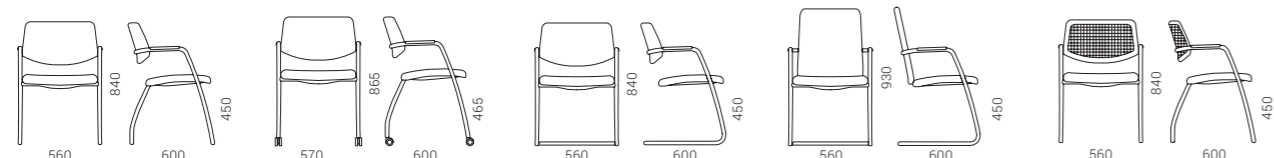

GAMA

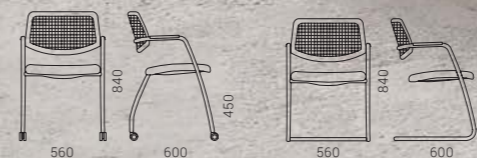

INTERIA  
DISTRIBUTED BY  
PT INTERIA REGALIA NUSANTARA  
hello@by-interia.com

GAMA

Light and graceful  
silhouette visitor chair

For convenient  
meetings

**368** The back of the visitor's chair can be combined with a lightweight and breathable polyester mesh that provides comfortable support and constant air circulation, or with a stiffer plastic mesh that provides greater support for the back.

Chrome-plated flexible steel frame legs ensure comfortable seating during long and intense meetings. During the moment of relaxation, you can easily swing in the chair.

## Compactness

You can easily stack EVA visitor chairs on top of each other (up to 3 pcs.).



STACKABLE

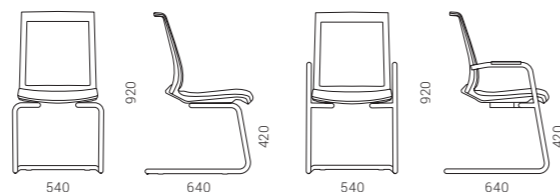

**VISITOR,  
CONFERENCE  
& DINING  
CHAIRS**

# AURA

> 298

TASK  
CHAIRS

> 324

EXECUTIVE  
CHAIRS



STACKABLE

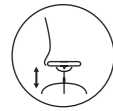

PNEUMATIC HEIGHT  
REGULATION

370



Easily adaptable  
design

Wide variety of fabric and leather colours allows you to choose a character for your chair - from modest, easily adaptable to different office interiors, to exclusive, attracting attention.

4 base types

Depending on your circumstances, you can choose between four different bases. All of them are chromed, making it easy to match them to various fabric types and colours.

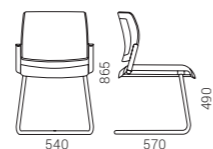
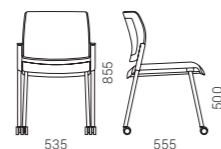
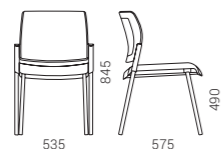

AURA

# DIVA

> 296

TASK  
CHAIRS

**VISITOR,  
CONFERENCE  
& DINING  
CHAIRS**



Thin line,  
delicate and  
modern design

371

The chair is available with either black polyamide or polished aluminum base with castors. Thanks to its simple and intuitive design, DIVA can be easily adapted to individual user needs.



TILT  
MECHANISM



TENSION  
ADJUSTMENT



PNEUMATIC HEIGHT  
REGULATION

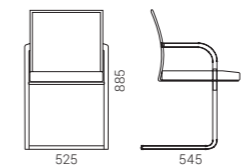
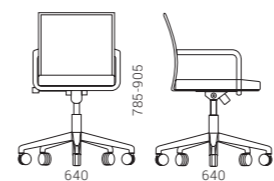

DIVA

# TWIST&SIT

Design by Christina Strand and Niels Hvass

> 344

VISITOR,  
CONFERENCE &  
DINING CHAIRS

> 392

SOFAS

> 416

LOUNGE CHAIRS

> 418

LOUNGE CHAIRS

> 424

ARMCHAIRS

372



These Scandinavian design chairs are a perfect fit for high tables in the lounge, cafeteria, or collaboration areas. With their appealing look, they will get employees together for lunch, coffee break, or for an informal meeting. The ergonomically shaped curves in both the seat and backrest give users extra comfort. You can select different colour combinations for the upholstered part of the chair and choose either metal or wooden legs. Contrasting colours will bring a sense of exclusivity to your TWIST&SIT furniture.

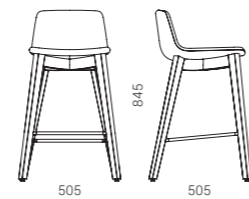
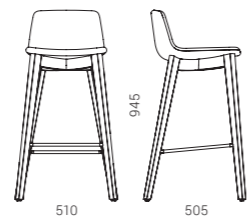
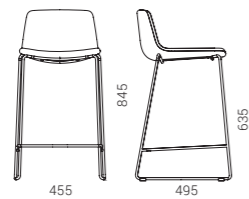
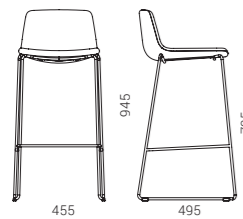

# CANNIE

Design by S.I. Design

Simplicity is  
comfort

The CANNIE collection of stools combines high-quality materials into a simple yet playful design that is easily adaptable to different interiors. CANNIE may look like a simple stool, but it is guaranteed to offer high quality and comfort to its users. One of the key elements that create a feeling of comfort is the seat, made of soft polyurethane. And when sitting on a high or medium high stool, you can place your feet comfortably on the footrest.



374

375

Wide range of  
applications

The collection consists of stools in three heights. CANNIE stools of different heights can be used in office collaborative or meeting spaces, an office kitchen as well as in public spaces.



CANNIE



CANNIE

# POLYTONE-L

Design by Scagnellato and Ferrarese Design

> 352

> 354

> 356

VISITOR,  
CONFERENCE &  
DINING CHAIRS

## Stylish one-colour combinations

The plastic seat comes in the same colour as the metal base, creating a uniform look. The five colour options including pastel shades, which are currently very popular, will help you create laconic one-colour combinations.

376



## Fixed cushion for added comfort

You can opt for a chair with a fixed cushion to ensure added comfort when sitting for extended periods of time. Our wide range of fabrics provides endless opportunities to mix and match the colour of the cushion with the colour of the plastic part of the chair.



STACKABLE

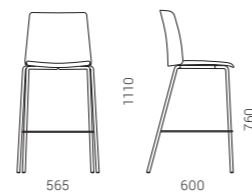

# MOON

> 294  
TASK CHAIRS

> 358  
VISITOR, CONFERENCE & DINING CHAIRS

MOON high chairs are a versatile option as they can be used for multiple purposes: in relaxation or dining areas as well as for short meetings.

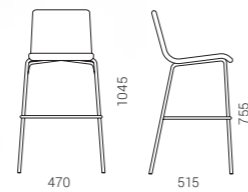

378

# MOON Wood

> 362  
VISITOR, CONFERENCE & DINING CHAIRS

If you are inspired by nature, you can choose plywood chairs covered with beech or oak veneer. If you prefer minimalist style, black stained beech veneer or white laminate will be an ideal choice for you.



STACKABLE

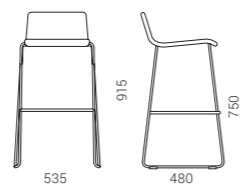

## Playful yet practical

Wait chairs are modern, practical and light, but at the same time durable. The delicately perforated back ensures air circulation. The chairs playfully combine two materials - plastic and fabric. You can choose from two models: a model where both the backrest and the seat are made of plastic and one that combines a perforated plastic backrest and a seat covered with a tapestry or leather look for a more comfortable seating.

380



381

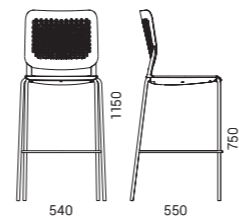

# LOUNGE & SOFT FURNITURE

## SOFAS

---



MYAMI

> 386

382



TWIST&SIT Soft

> 392



ARCIPELAGO

> 396

## LOUNGE CHAIRS

---



MYAMI

> 402



TWIST&SIT

> 418

383



SANDIE

> 406



ARCIPELAGO

> 396



SOFT ROCK

> 410



VEGAS

> 422



TWIST&SIT Soft

> 416

# ARMCHAIRS



**TWIST&SIT**  
> 424



**TULA**  
> 428



**DANAE**  
> 426



**NORTH CAPE**  
> 346



**MEG**  
> 427

384

# MODULAR SYSTEMS



**SOFT ROCK**  
> 410



**ARCIPELAGO**  
> 396



**JAZZ Chill Out**  
> 430

# POUFS



**ZooZoo**  
> 432



**GIRO**  
> 434



**JAZZ Chill Out**  
> 430



**ARCIPELAGO**  
> 396

385

# MYAMI

Design by MUCNYC

> 402

LOUNGE  
CHAIRS

“

*The MYAMI collection is inspired by the unique blend of elegance and energy found in classic Art Deco design. It is designed to make you feel instantly at home and allows everyone to create their own version of comfort and style.*

Stefanie Kubanek and Michael Geldmacher

386



## Home in your office

MYAMI is a soft furniture collection that blends exceptional comfort with a home-like cosiness, creating a pleasant experience in the office—whether for relaxation, informal conversations, or collaboration. It consists of three types of soft furniture: a two-seater sofa, a three-seater sofa and a lounge chair.

## Exceptional comfort

High-quality MYAMI collection furniture is suited for different people. The cushions and seat, made of layers with varying firmness, adapt to the user's body, ensuring even weight distribution and balanced softness. Large, soft backrest cushions and smaller side cushions gently embrace the seated person, providing exceptional comfort for relaxation and rest. The side cushions are also highly convenient for resting the arms.

387



# Timeless, elegant design

The modern architecture characteristic of Miami's South Beach district, which evolved from the Art Deco style, is distinguished by clean geometric lines with decorative accents and rounded or curved edges. This aesthetic served as the inspiration for this soft furniture collection. The MYAMI sofas and lounge chair stand out with a seamless, curved backrest that subtly embraces the seating area.

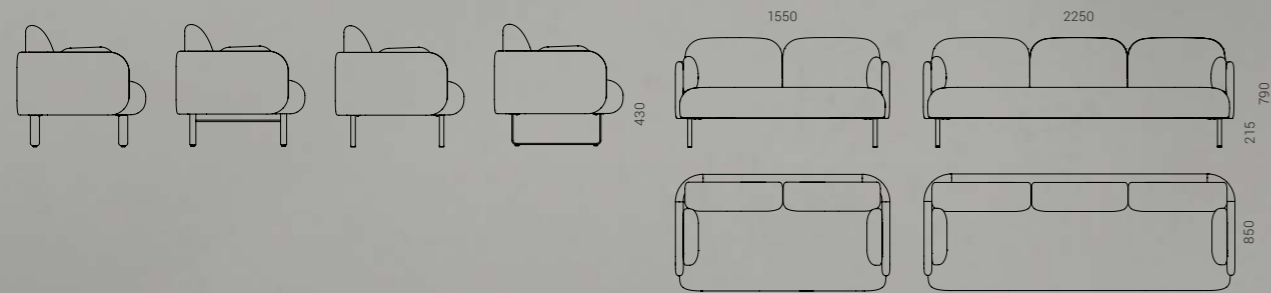

390

391

DREAM  
G004

# TWIST&SIT

## Soft

Design by Christina Strand and Niels Hvass



392

- > 344  
VISITOR,  
CONFERENCE &  
DINING CHAIRS
- > 372  
HIGH  
CHAIRS
- > 416  
> 418  
LOUNGE CHAIRS
- > 424  
ARMCHAIRS

An ultimate sense  
of comfort

TWIST&SIT Soft seaters ensure a comfortable sitting experience thanks to the increased thickness of the polyurethane padding. The recessed lower part of the backrest subtly conforms to the natural contours of the spine, making the user feel comfortable.

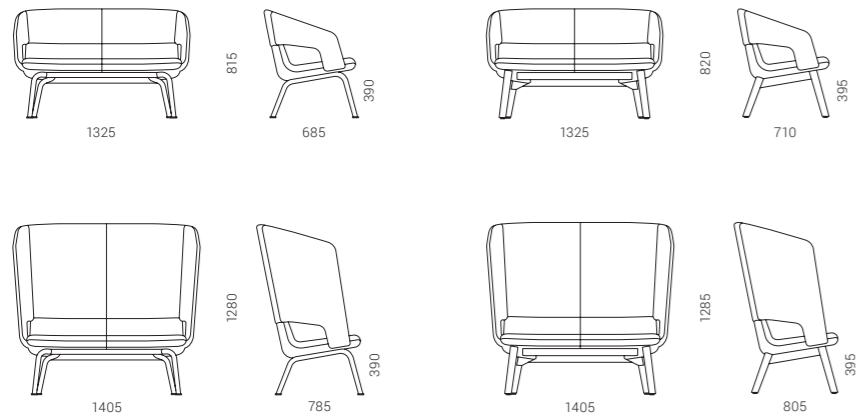

TWIST&SIT Soft

Meets  
the diverse  
needs of  
employees

Low-back armchairs and sofas are ideal for office reception areas or open-plan relaxation spaces, lounge zones or cafés. High-back seaters are a convenient solution for employees who need a private space for themselves where they can escape from the noisy office environment and relax or focus on individual tasks.



393

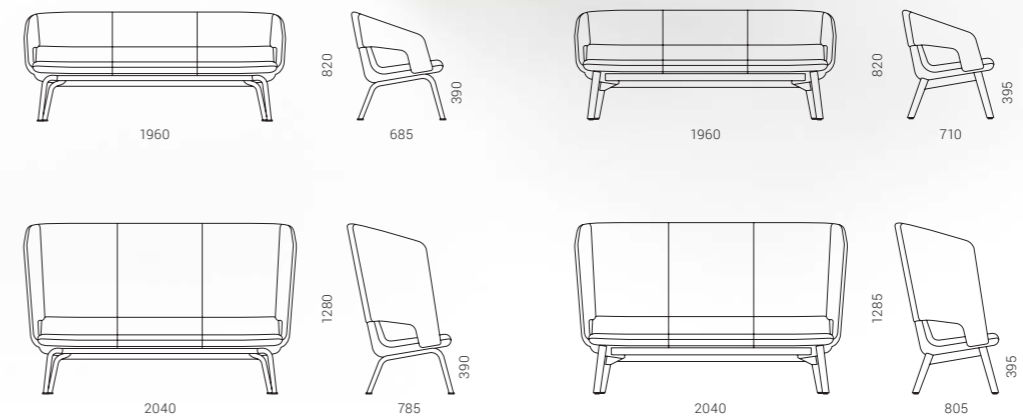

TWIST&SIT Soft

SOFAS

SOFAS

ERA  
GC39

394

PET felt  
BA02

PET felt  
BA11

PET felt  
BA12

PET felt  
BA01

SYNERGY  
GS74

SYNERGY  
GS73

STEP Melange  
GL12

395

SOFAS,  
LOUNGE  
CHAIRS,  
MODULAR  
SYSTEMS  
AND POUFS

# ARCIPELAGO

Design by Baldanzi & Novelli designers

> 248  
ACOUSTIC  
FURNITURE

SOFAS,  
LOUNGE  
CHAIRS,  
MODULAR  
SYSTEMS  
AND POUFS

## Release your creativity with ARCIPELAGO!

Arcipelago is a modular lounge seating system offering endless configuration possibilities. Choose your favourite configuration from our wide range of standard options or build your custom configurations by mixing and matching modular components. ARCIPELAGO modular configurable system is easy to assemble, disassemble, or reassemble.



396



## Playful colours

397

Choose from our wide range of fabrics and colours or mix and match them to create a unique atmosphere for your office. The backrest and seat cushions can be easily removed and swapped.

ARCIPELAGO

ARCIPELAGO

INTERIA  
DISTRIBUTED BY  
PT INTERIA REGALIA NUSANTARA  
hello@by-interia.com

**SOFAS,  
LOUNGE  
CHAIRS,  
MODULAR  
SYSTEMS  
AND POUFS**

## 3 heights

Thanks to their flexibility and 3 different height options, ARCIPELAGO lounge benches are a great choice for spaces of any size and style. The high-back option will provide you with more privacy and acoustic comfort.

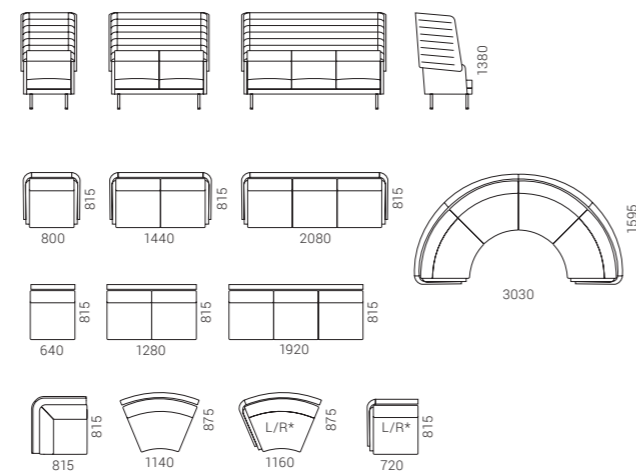
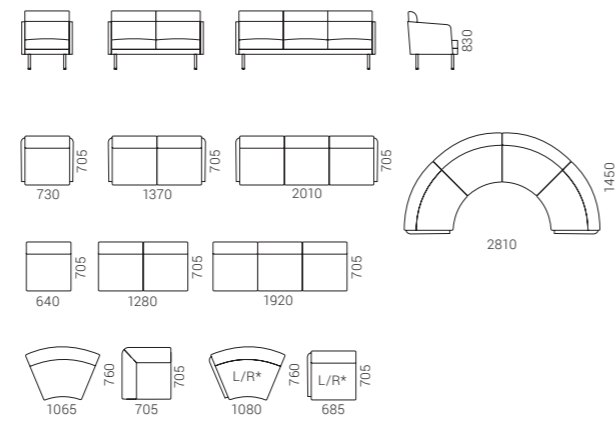
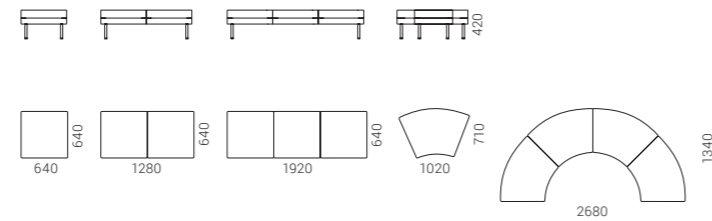

\* - left/right

398

## Useful accessories

Lounge benches come with well-designed accessories. You can choose a table or armrest with or without an integrated power socket or USB fast charger. Both of these can be easily mounted in between the seats.

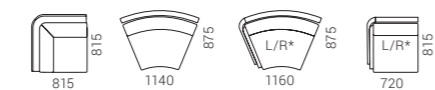
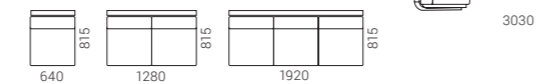
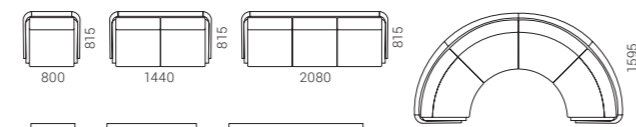
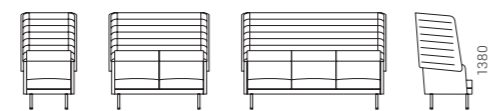
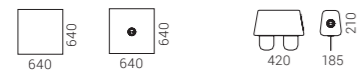

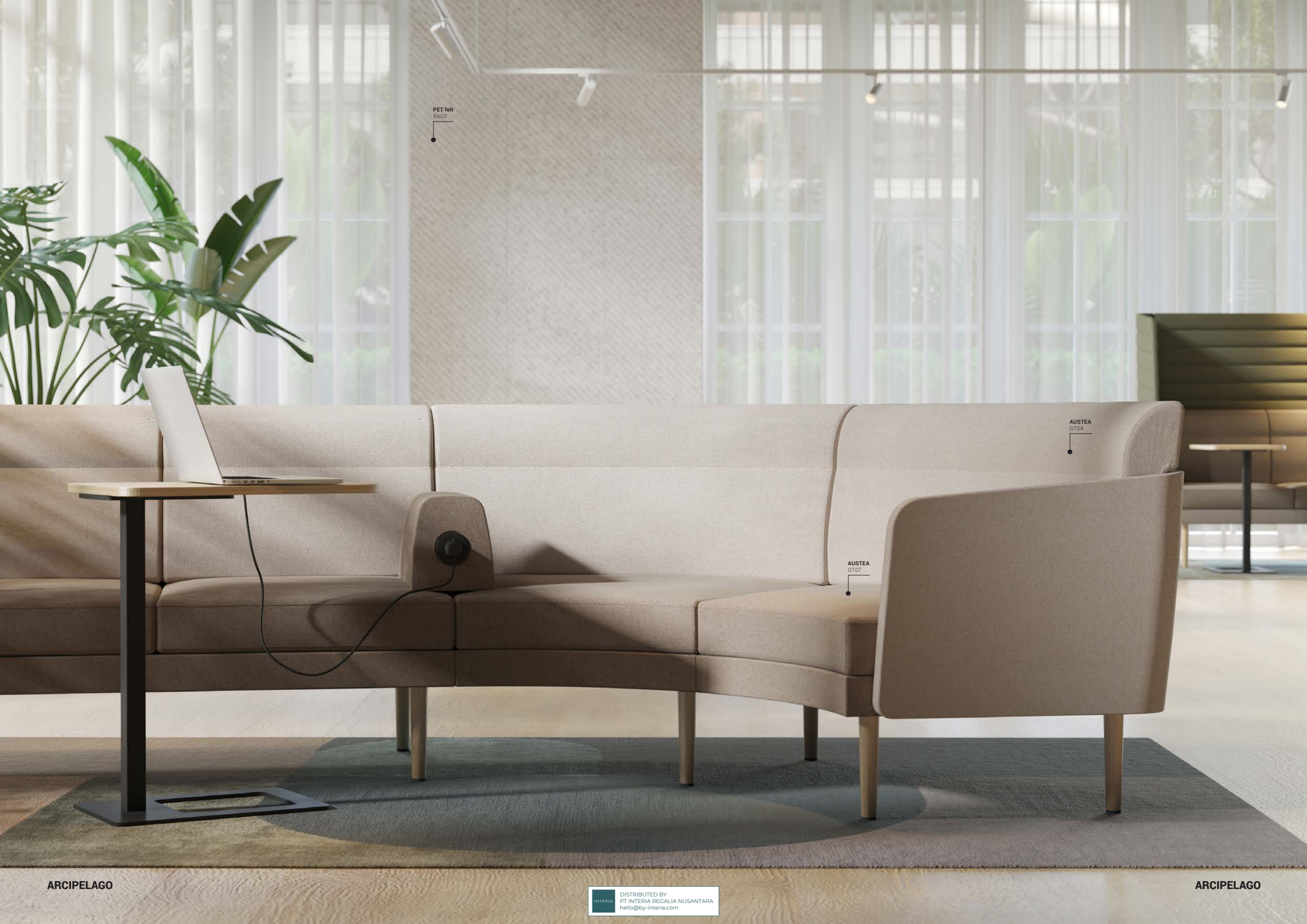

PET felt  
BA02

AUSTEA  
GT04

AUSTEA  
GT07

# MYAMI

Design by MUCNYC

> 386  
SOFAS



402

## Subtle rounded shapes

MYAMI soft furniture has been designed with great attention to detail and craftsmanship. Its sleek, seamless design, characterised by subtly rounded shapes and lines echoed in the cushions, armrests, seat, and wooden legs, creates a sense of cosiness and naturally draws you in to sit down.



403

**LOUNGE  
CHAIRS**

Four bases to create  
different characters

Metal legs are an economical, versatile choice for many modern office interiors.

Metal sled legs – perfect for achieving a formal, refined look.

Soft furniture with solid ash wood legs combines modernity and cosiness and will appeal to those who appreciate a less formal look.

Solid ash wood frame with legs – the most home-like option, particularly well-suited for classic interiors.

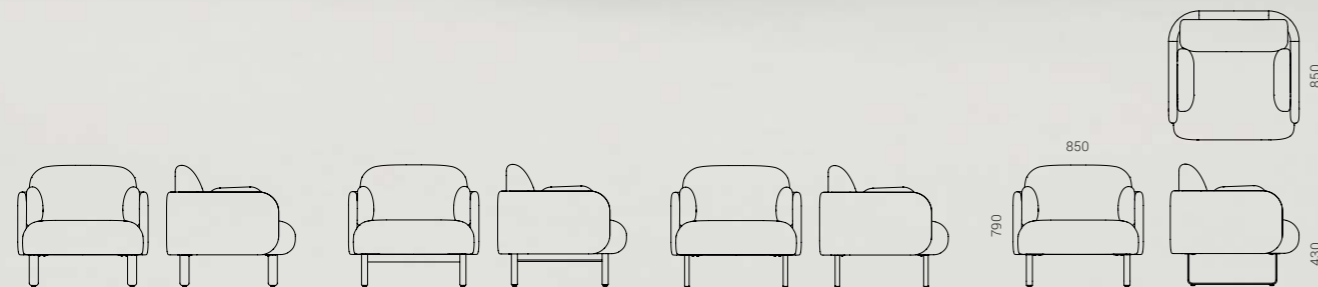

**MYAMI**



PET felt  
BA02

405

DREAM  
G003

**MYAMI**

# SANDIE

Designed by "Baldanzi & Novelli designers"

> 268

TASK  
CHAIR

> 314

EXECUTIVE  
CHAIRS

> 336

VISITOR,  
CONFERENCE &  
DINING CHAIRS

“

*The SANDIE collection harmoniously combines functionality and aesthetics to provide a pleasant and comfortable sitting experience.*

Baldanzi & Novelli designers



406

For relaxation areas that you will not want to leave

Soft, cosy furniture is increasingly used in the lounge areas of dynamic offices, providing a pleasant place for employees to relax and recuperate during the working day. The SANDIE collection includes two types of lounge chairs, available with high or low backrest options.

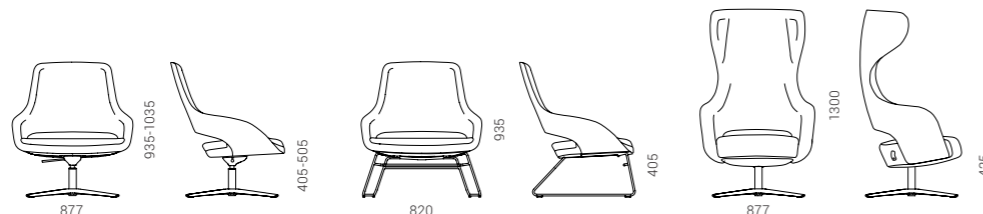

## Undeniably comfortable low-back lounge chairs

The low-back lounge chairs have an extra cushion that provides an even more pleasant softness, and the wide seat is spacious enough to make you feel comfortable and relaxed when sitting.

## High-back lounge chairs for comfort and privacy

The new synchronous mechanism integrated into the high-back lounge chairs allows you to relax and enjoy the comfort. By leaning back, you can adjust the angle of the backrest by up to 16 degrees to achieve the perfect level of comfort for you. The pleasantly enveloping high backrest gives you privacy and isolates you from surrounding noise, while the softness of the lounge chairs allows you to completely immerse yourself in a comfortable moment of relaxation.



407

CYBER  
GB17



CYBER  
GB14



CYBER  
GB11



PET felt  
BA02



CYBER  
GB16



# SOFT ROCK

Design by Christina Strand and Niels Hvass

Inspired by the new generation

Being open to new things, a sense of freedom, and the ability to adapt quickly to changing situations were the source of inspiration behind SOFT ROCK lounge seating collection.



410

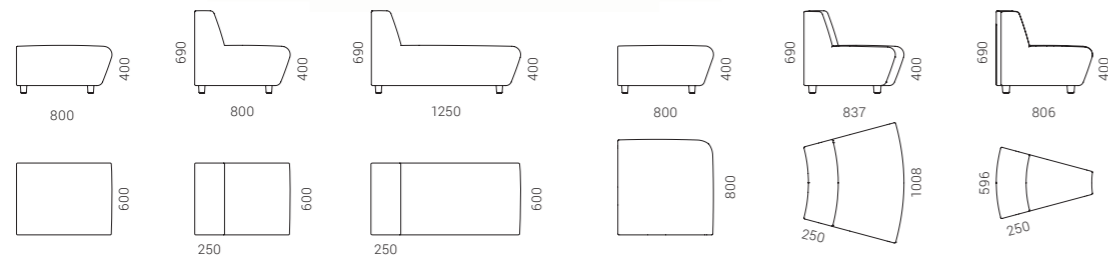
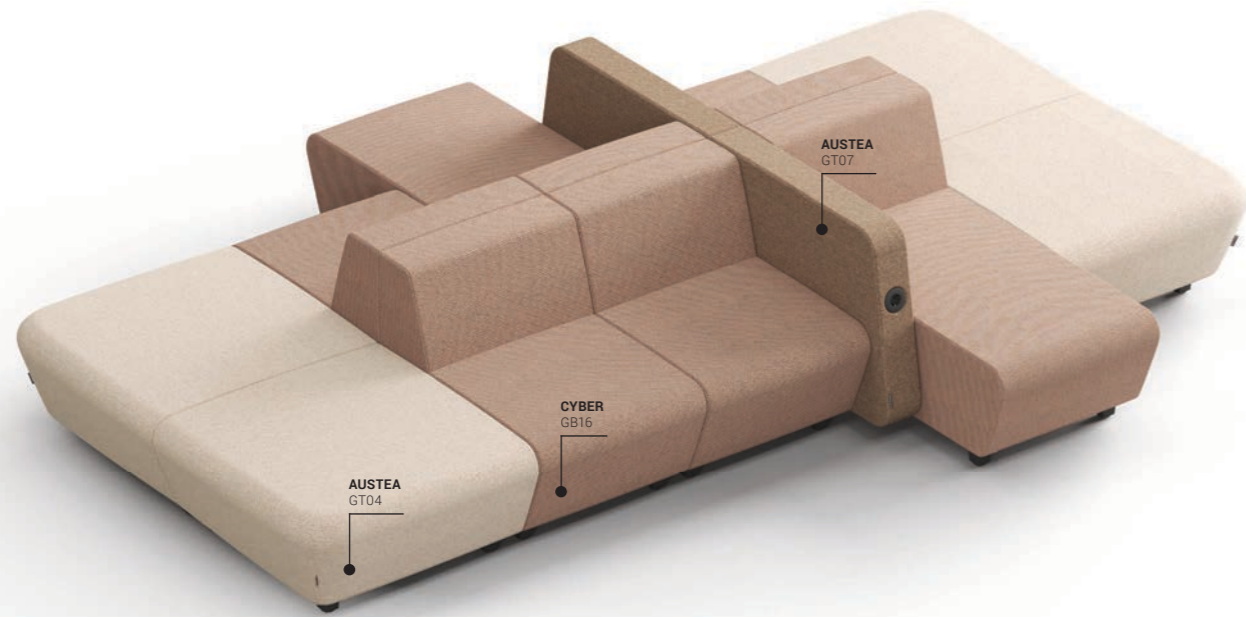

SOFT ROCK

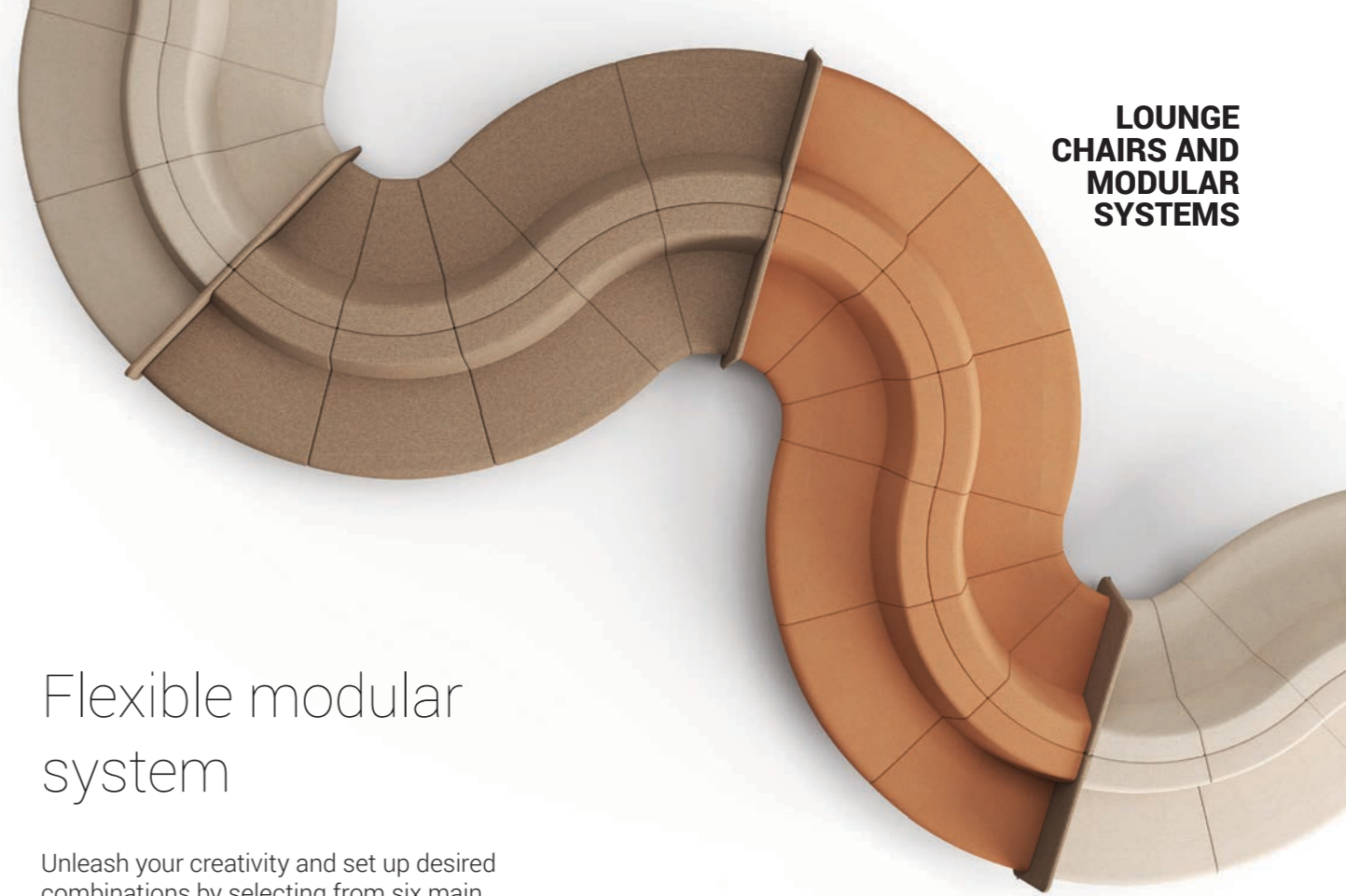

Flexible modular system

Unleash your creativity and set up desired combinations by selecting from six main lounge seaters available in different sizes and forms, which can be easily combined or rearranged to make efficient use of the space. Depending on your actual needs, use additional accessories – armrests and screens to make the most of your lounge seater composition.

411



**LOUNGE  
CHAIRS AND  
MODULAR  
SYSTEMS**

Privacy and safety

It is a perfect tool allowing you to create a more private area for individual work that requires concentration within an open space. Also, thanks to the screens, you can create a safe atmosphere by ensuring desired distances between people without totally isolating them.

412

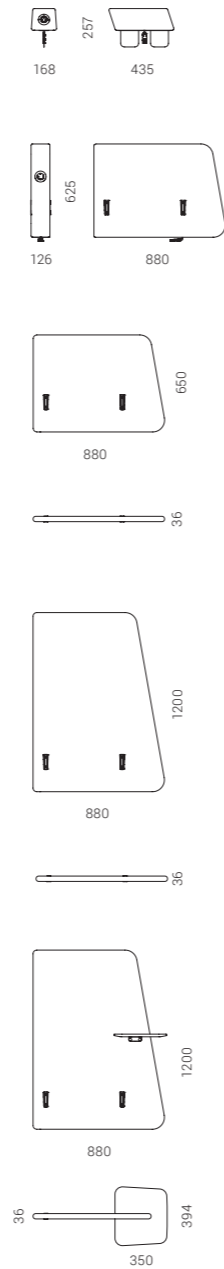

Always  
"connected"

**LOUNGE  
CHAIRS AND  
MODULAR  
SYSTEMS**



In order to meet your need for constant connectivity, the armrests of the SOFT ROCK furniture have in-built power sockets or fast charging USB (Type A+C) ports.

RNN  
DZ05

**SOFT ROCK**

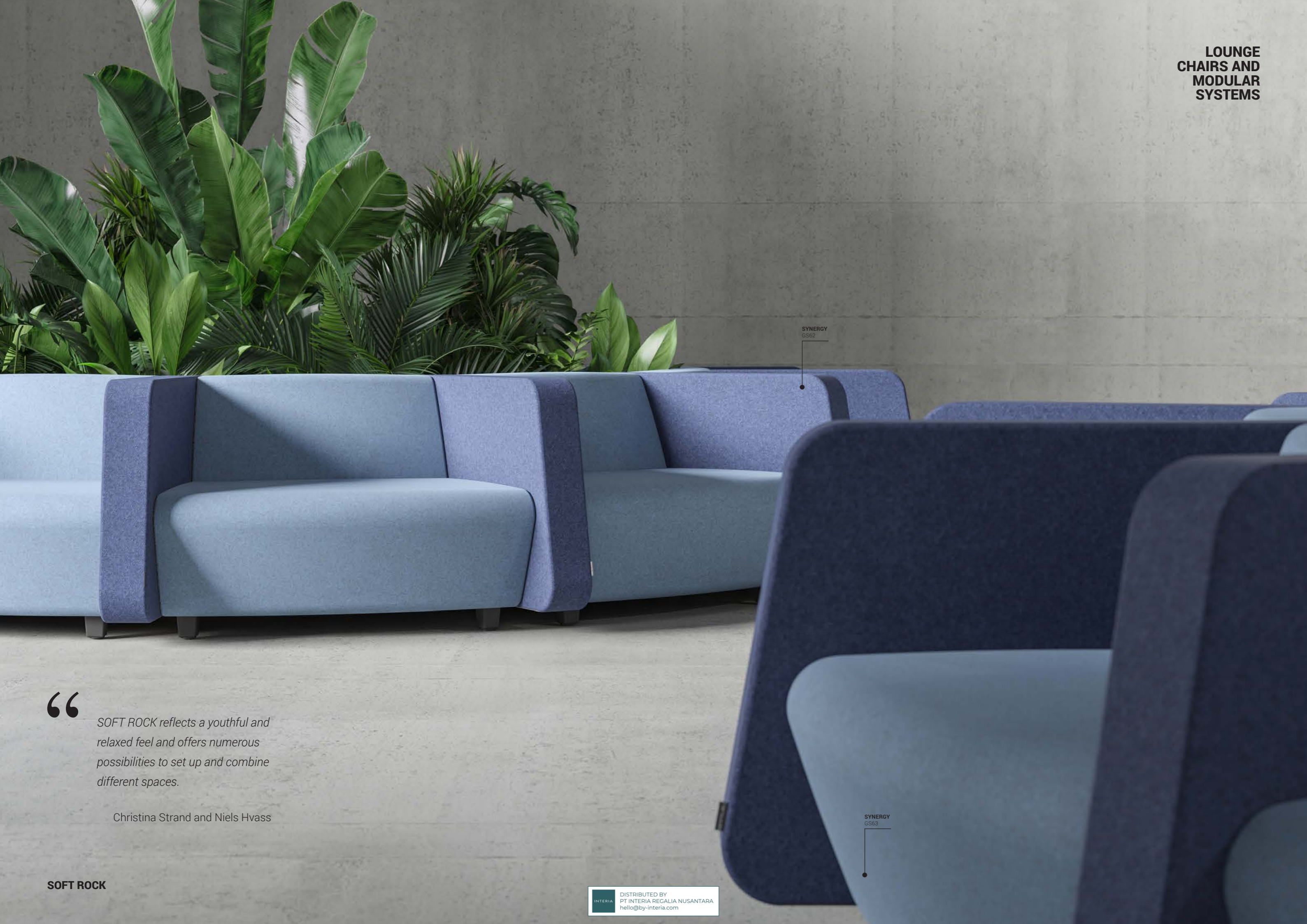

SYNERGY  
GS62

SYNERGY  
GS63

“

*SOFT ROCK reflects a youthful and relaxed feel and offers numerous possibilities to set up and combine different spaces.*

Christina Strand and Niels Hvass

**SOFT ROCK**

# TWIST&SIT

## Soft

Design by Christina Strand and Niels Hvass

- > 344  
VISITOR,  
CONFERENCE &  
DINING CHAIRS
- > 372  
HIGH  
CHAIRS
- > 392  
SOFAS
- > 418  
LOUNGE CHAIRS
- > 424  
ARMCHAIRS

416



Exceptional design  
rhythms

Well-rounded shapes and a distinctive connection between the lower and upper parts of the backrest create an instantly recognisable look.

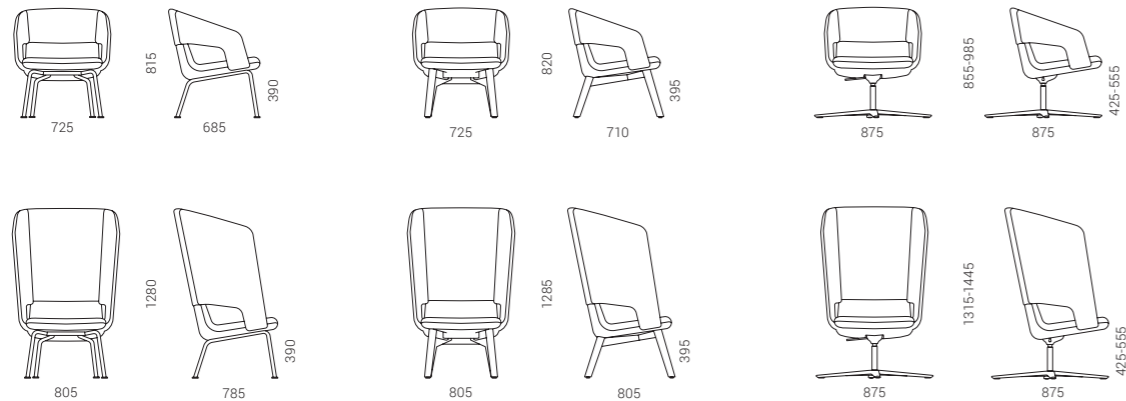

TWIST&SIT Soft

An invitation to pause

TWIST&SIT Soft lounge furniture with its expressive design is an invitation to pause and to take a break from the hectic pace of the day.

417



PNEUMATIC HEIGHT  
REGULATION

# TWIST&SIT

Design by Christina Strand and Niels Hvass

> 344

VISITOR,  
CONFERENCE &  
DINING CHAIRS

> 372

HIGH  
CHAIRS

> 392

SOFAS

> 416

LOUNGE CHAIRS

> 424

ARMCHAIRS

418



reddot award 2019  
winner

An exclusive design of TWIST&SIT chair will be a spotlight of any office. It has a well-rounded high backrest shelter which isolates the users from surrounding noise, giving them a sense of comfort, protection, and minimizing distractions. The seat of the TWIST&SIT is wider than a typical size seat, thus it allows you to relax and enjoy an ultimate sense of comfort. The chair will add a special touch to both formal and informal meeting spaces or relaxation areas.



## LOUNGE CHAIRS

Distinctive  
character and  
freedom of  
expression for  
your style

You can select different colour combinations for the upholstered part of the chair. Contrasting colours will bring a sense of exclusivity to your TWIST&SIT furniture. It also comes in a variety of different base options so there is no need to compromise on style. When choosing the right one, consider your functional needs as well as the fabric or design to accommodate your preferences.

420



421



PNEUMATIC HEIGHT  
REGULATION

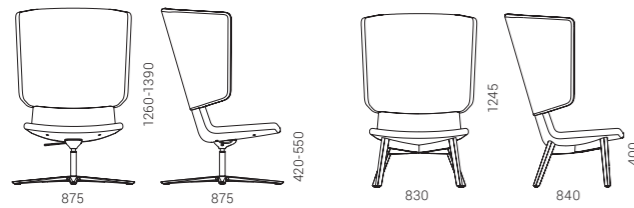

TWIST&SIT

INTERIA DISTRIBUTED BY  
PT INTERIA REGALIA NUSANTARA  
hello@by-interia.com

TWIST&SIT

# VEGAS

A temptation  
to relax

A curved shape, lower and wider  
seating area implies a welcoming  
invitation to have a seat for  
anyone passing by.

422



The chair shell can be upholstered with different  
fabric combinations, leather look, or genuine leather.  
Chromed steel sled frame base create a distinctive  
character and provide durability while plastic glides  
help prevent floor damage.

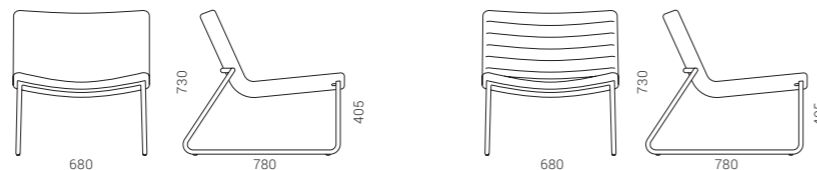

# TWIST&SIT

Design by Christina Strand and Niels Hvass

- > 344  
VISITOR,  
CONFERENCE &  
DINING CHAIRS
- > 372  
HIGH  
CHAIRS
- > 392  
SOFAS
- > 416  
> 418  
LOUNGE CHAIRS



424

TWIST&SIT furniture stands out for its minimalist and clean refined lines as well as strong visual identity. The rounded edges and smooth transitions between the backrest and the armrests offer a comfortable seating position even if the work meeting lasts longer than expected.

TWIST&SIT chairs with metal bases have a more modern look, whereas the wooden ones give the office a more homely feel and at the same time add more elegance to the room. Both base options are available in dark and light colours to further add to the beauty of contrast.

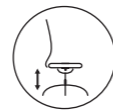

PNEUMATIC HEIGHT  
REGULATION

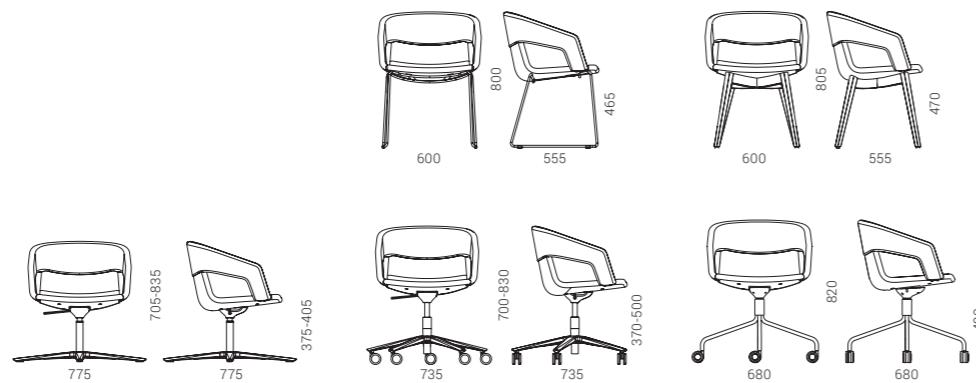

# DANAE

Make your office stand out

This chair is a perfect combination of elegance and comfort. A charming silhouette creates a sophisticated look and a welcoming feeling that is why this chair will perfectly blend in any conference room or waiting area.

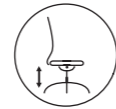

PNEUMATIC HEIGHT REGULATION



426

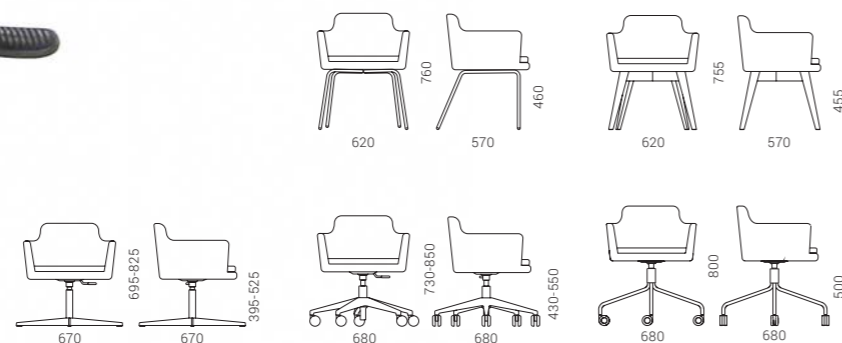

DANAE

INTERIA DISTRIBUTED BY  
PT INTERIA REGALIA NUSANTARA  
hello@by-interia.com

# MEG

A distinctive addition to your office

With its contemporary shape, MEG lounge chair will definitely find a place in any office space. A laconic design will suit those who appreciate a moderate style.

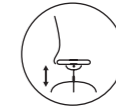

PNEUMATIC HEIGHT REGULATION



427

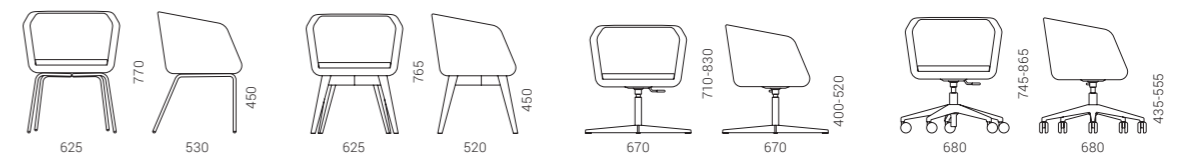

MEG

# TULA

## Designed to bring comfort

It is a perfect fit for lounge and waiting areas or informal meeting spaces. The distinctive design of the chair is made to wrap itself around the user and provide not only a comfortable sitting experience but also coziness.

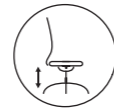

PNEUMATIC HEIGHT REGULATION

428



429

## Custom features for unique looks

TULA chairs are highly customizable as you can select individual colours for the front and back parts of the chair. You can even mix and match different materials for the separate parts of the upholstery. With our wide selection of fabric, leather look, genuine leather, the chairs can be adapted for a number of unique situations and looks.

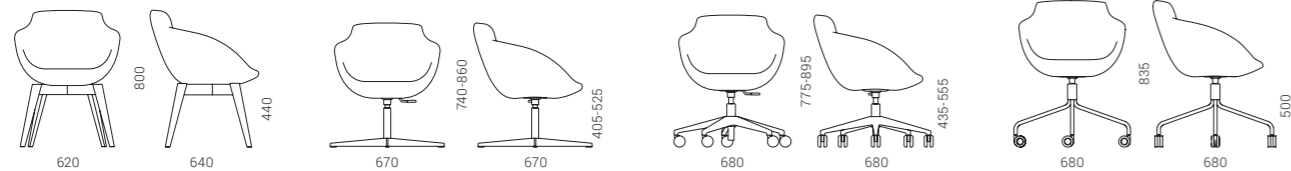

TULA



MODULAR  
SYSTEMS  
AND POUFS

# JAZZ Chill Out

Design by Christina Strand and Niels Hvass

> 238  
ACOUSTIC  
FURNITURE

## Freedom of improvisation

JAZZ Chill Out is an easily customizable pouf system for any lounge or waiting area in your office. A wide selection of fabric, artificial, and natural leather finishes opens up unlimited possibilities to create the desired interior atmosphere.

430



## Convenient details for contemporary people

For the convenience of users, the poufs can have an integrated plug or USB fast charging socket - an extremely practical solution for not only office workers but for visitors as well. Another functional highlight of this system is the metal table, which can be easily placed on the surface of the pouf to protect objects from falling.

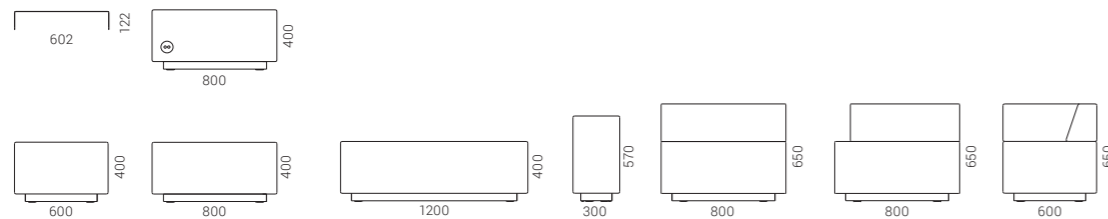

JAZZ Chill Out



POUFS

# ZooZoo

Designer Annie Lee

> 96  
CONFERENCE  
& MEETING  
TABLES  
  
> 140  
OCCASIONAL  
TABLES



432

## Designed for maximum comfort

The compact poufs can be easily tucked under the coffee table and pulled out again to create a pleasant place to sit. The niche in the pouf is ideal for temporarily storing small items or simply a handbag during a meeting.

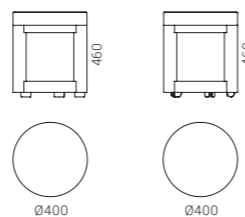

ZooZoo

INTERIA DISTRIBUTED BY  
PT INTERIA REGALIA NUSANTARA  
hello@by-interia.com

POUFS

## Modern and light design

The niche under the seat of the pouf not only provides additional functionality and storage for small items but also helps to maintain the unity of the design language throughout the ZooZoo collection.



ZooZoo

# GIRO

A true colour pallet  
at your office



GIRO pouf system is a great way to liven up any office environment and create the desired mood by choosing matching or contrasting colours. A wide selection of fabric, leather look and genuine leather is available for this pouf system upholstery. Small, lightweight, and mobile GIRO can be effortlessly rearranged in space.

434

## Customizable design

Variation of three different diameters and three different heights allows the user to choose the one that best suits their needs - it can be used both for sitting at a colleague's workplace or placed in the waiting and lounge areas. There are 2 base options available for GIRO system - with plastic glides or castors. Choosing plastic supports will create a more tidy office look while choosing castors will allow you to move the furniture around without much effort.

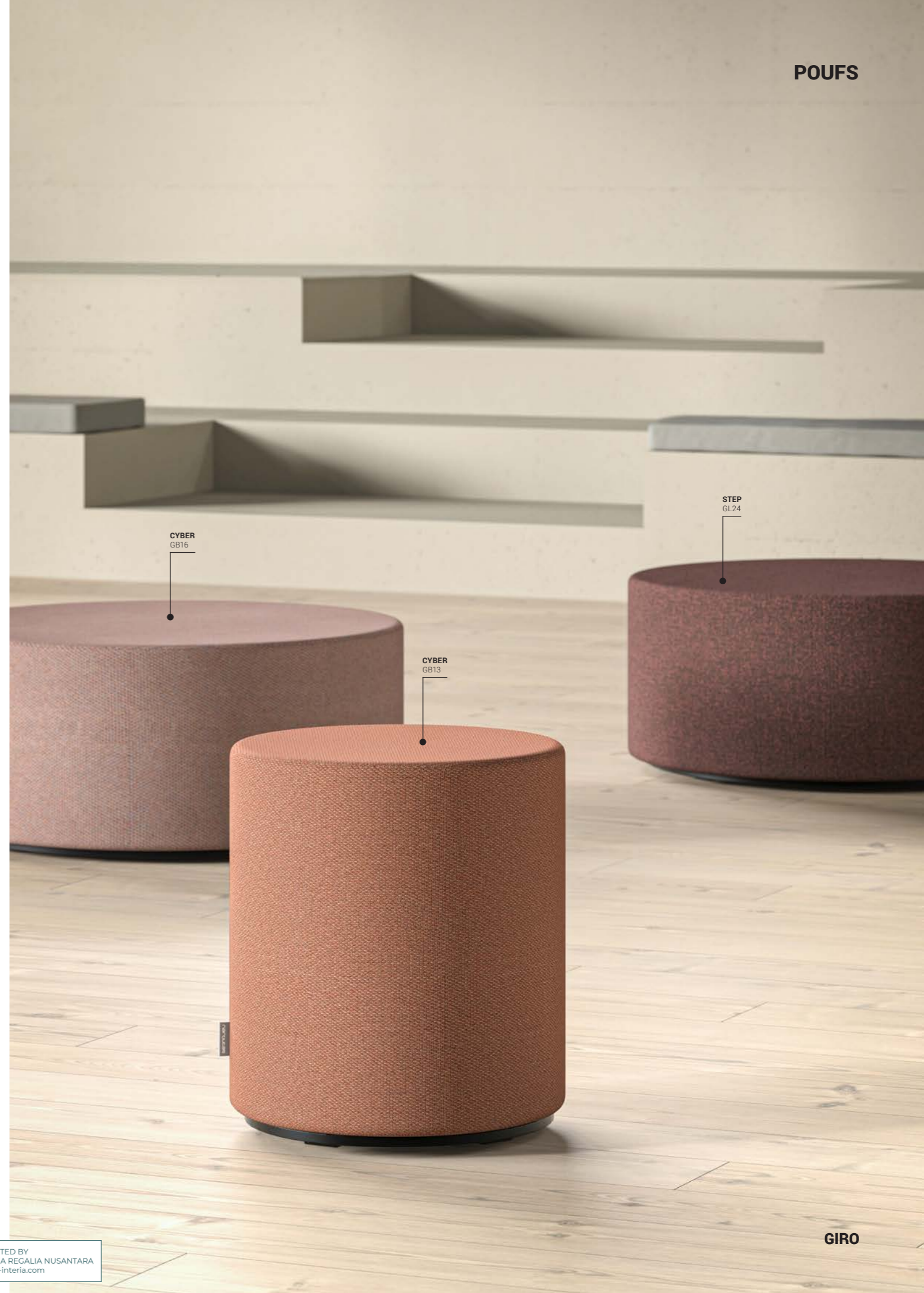
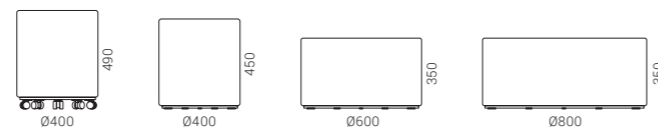

# EXECUTIVE FURNITURE



ARQUS  
> 438



PLANA  
> 458



MOVE&LEAD  
> 446



AIR Executive  
> 462



MOTION Executive  
> 452

# ARQUS

Designer Orlandini Design

> 92

CONFERENCE  
& MEETING  
TABLES



“

*My goal was to update the executive area and the related furnishing elements, by maintaining the representative importance, but conferring it with lightness and dynamism.*

Orlandini Design



ARQUS

INTERIA DISTRIBUTED BY  
PT INTERIA REGALIA NUSANTARA  
hello@by-interia.com

## Modern luxury design

ARQUS executive furniture has a modern aesthetic that appeals for its simplicity and elegance. The sturdy structure of the metal table legs is a distinctive design element that adds a sense of lightness, longevity, and durability to the piece of furniture.

The sleek, subtly rounded shapes and lines of ARQUS are reflected in every part of the furniture – in the shape of the legs, the chamfers of the tabletop or cabinets. All the details come together to create a flawless design.

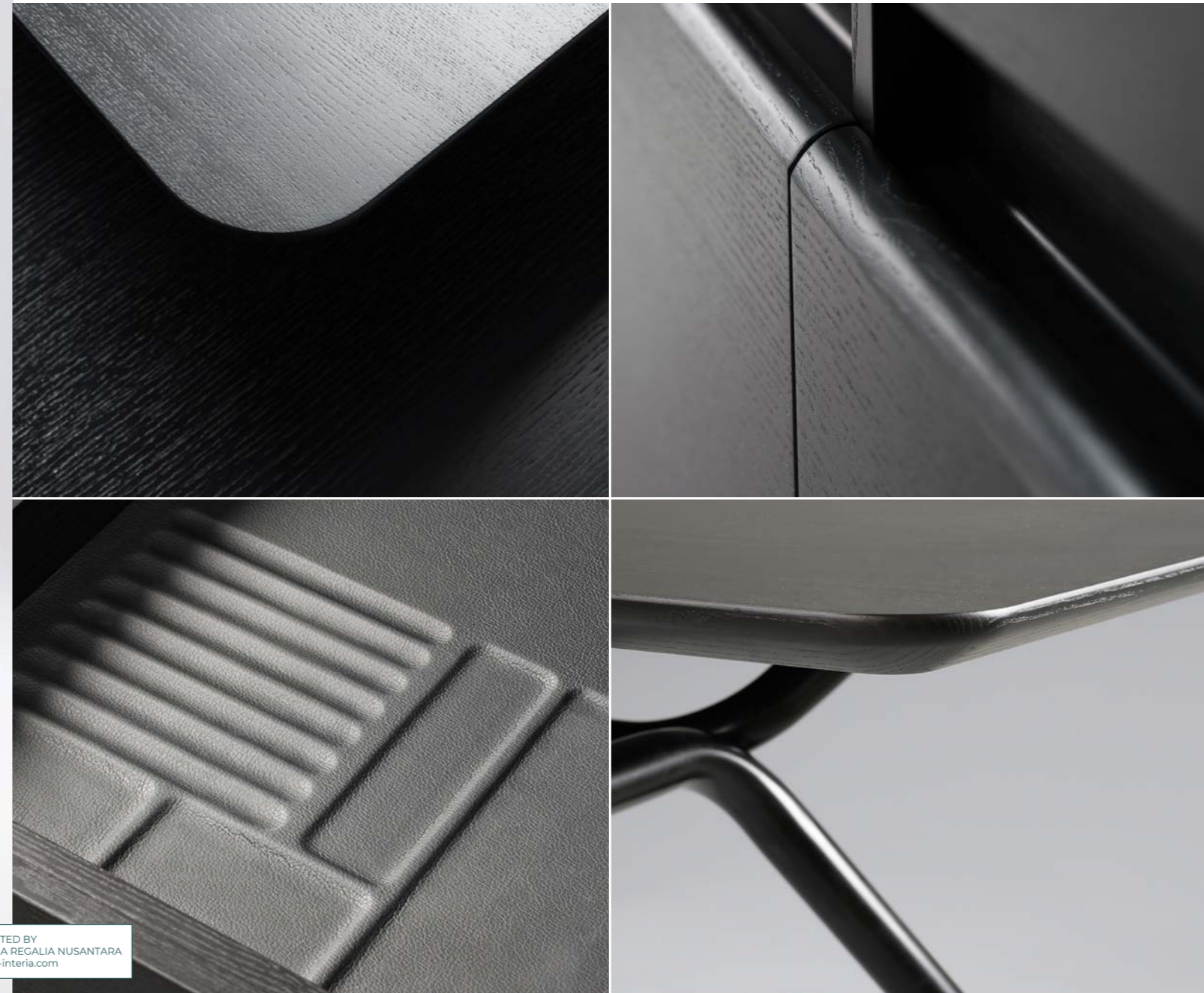

**EXECUTIVE  
FURNITURE**

Convenient  
storage  
solutions

A fixed pedestal to the left or right of the desk allows you to free up desk space for work. In addition, you can store your valuables in a lockable drawer.

A wardrobe is spacious enough to comfortably accommodate the outerwear of the manager as well as that of meeting participants.

A free-standing cabinet with two doors provides an additional storage space.

440

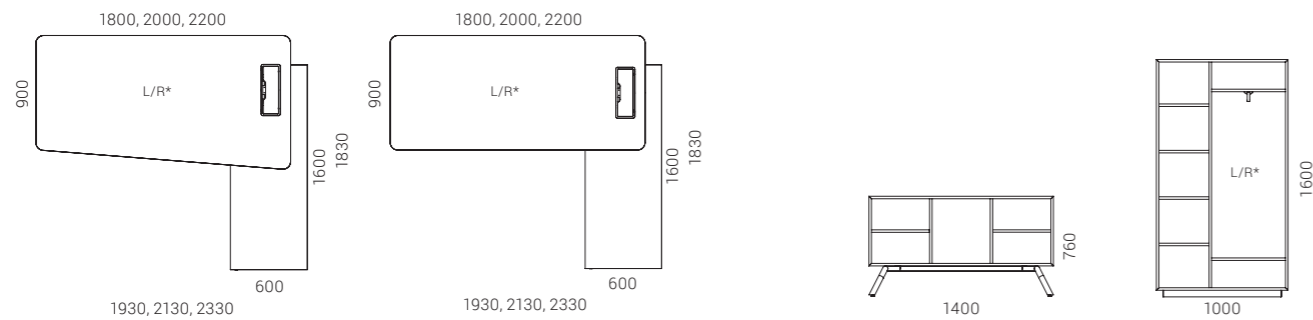

\* - left/right

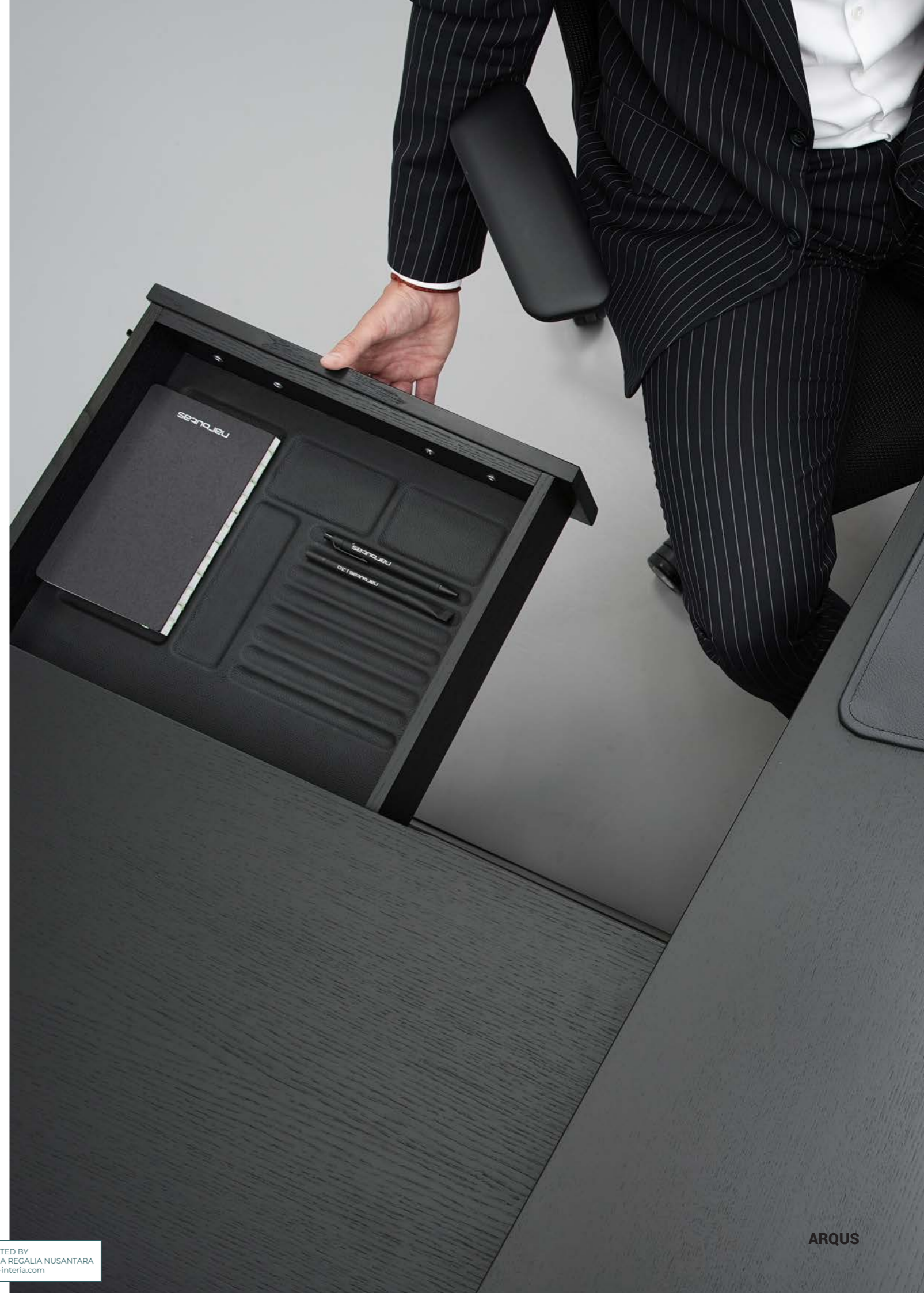

## Accessories to complete the collection

You can use a modesty panel to enhance your privacy and create a sense of personal space. A leather table mat provides a smooth and comfortable writing surface and enhances the tactile experience when writing or using a computer mouse.

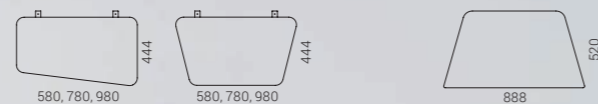

## Desktops in two shapes

Large desktops are designed for convenient storage of personal items and work tools within easy reach. You can also choose a desk with a regular rectangular desktop or an asymmetrical option with a desktop tapering to the left or right.

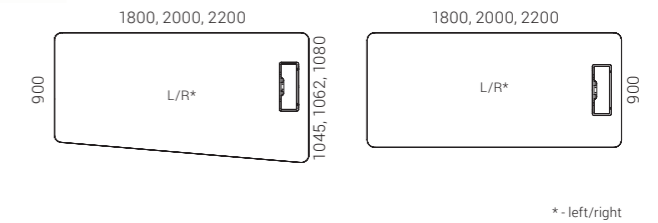

## Well-thought-out power solutions

Thoughtful power solutions will allow you to have a comfortable place to work or hold meetings. Executive desks have built-in power socket blocks.

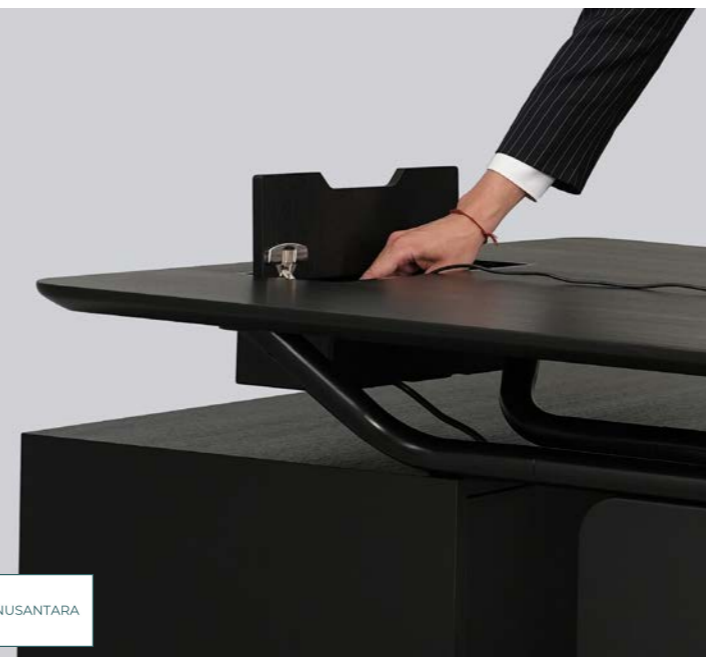

EXECUTIVE  
FURNITURE



AUSTEA  
GT04

Modern luxury  
with character

The ARQUS collection consists of desks, meeting tables, wardrobes and cabinets. By using different pieces of furniture united by design elements, you can create a stylistically unified and harmonious executive work environment.

INTERIA  
DISTRIBUTED BY  
PT INTERIA REGALIA NUSANTARA  
hello@by-interia.com

ARQUS

# MOVE&LEAD

Design by Gediminas Juška

“

*Move! is a slogan of the modern man that represents the victory of mobility against stagnation, sloth and succumbing to negativity. A true modern leader is driven and open to innovation, a cosmopolitan dictating healthy lifestyle and a teacher who shapes his or her environment with dignity.*

Gediminas Juška

## Every detail matters

MOVE&LEAD is a top-quality product which stands out for its uncompromising standards of excellence in craftsmanship. Curved wooden surfaces are shaped employing traditional manufacturing methods and following highest quality standards. Parts of different materials are joined together with every detail in mind.

## Your best move!

It combines the best in ergonomics and cutting-edge technology and is designed for modern active leaders. The desk's height can be adjusted between 740 mm and 1300 mm, this allows you to stay on the move and be active even at your desk.

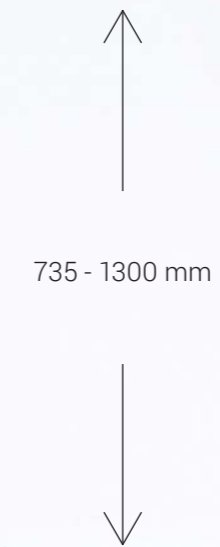

**EXECUTIVE  
FURNITURE**

Minimalism is  
the new luxury

Clean, elegant lines, smooth transitions and subtle combinations of materials are guaranteed to make a strong visual impact in any office. HPL Fenix finish, natural oak, ash or walnut veneer and polished stainless steel surfaces form a harmonious whole and create a sense of subtle luxury.

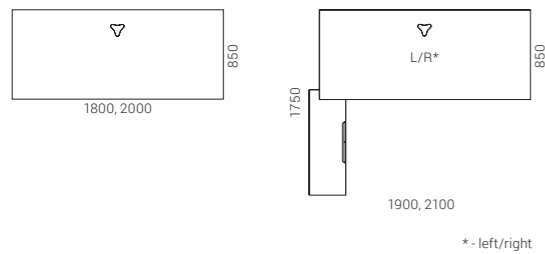

Declutter your  
workplace

The hidden wires can be accessed by opening an elegant minimalist lid. Wires and cables are routed through a subtle triangular-shaped hole with an original cover in a colour that matches that of the desktop or natural wood. MOVE&LEAD desk also has an in-built best-in-class Qi wireless charger (15W) for your smart devices.



Everything you need

Besides fixed-height or height-adjustable desks, MOVE&LEAD executive furniture system also includes storage solutions to keep your office essentials and personal belongings close at hand. The desk cabinet drawers with special inserts will ensure a well-organised workspace.

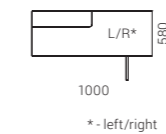

**MOVE&LEAD**

EXECUTIVE  
FURNITURE

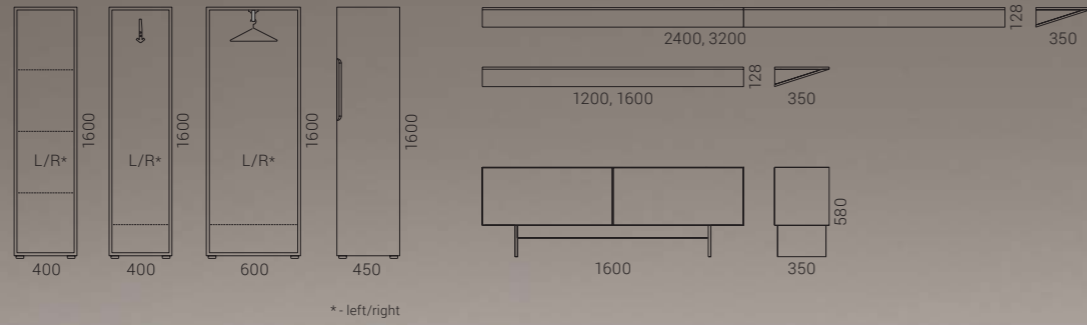

PET felt  
BA02

AUSTEA  
GT04

# MOTION Executive

> 36  
SIT-STAND  
DESKS

Modern desk for  
an active leader

MOTION Executive is a system of electric height adjustable desks, designed for a workplace of a dynamic leader. This desk is a combination of modern elegance and thoughtful functionality.

452



Modern  
sophistication

Panel legs hide the space under the desk giving more visual privacy. The feeling of elegance and sophistication is strengthened by the huge size of the top, which is designed for comfortable work. MOTION Executive can have even 36 colour combinations and allows you to create a desk which will suit your interior and personality best.



## EXECUTIVE FURNITURE

### Easy to use

You can adjust the height of the desk by simply pressing the button or with a remote control application on your smart device. You can save the most comfortable positions and get a reminder to change your body position: to stand up or sit down.

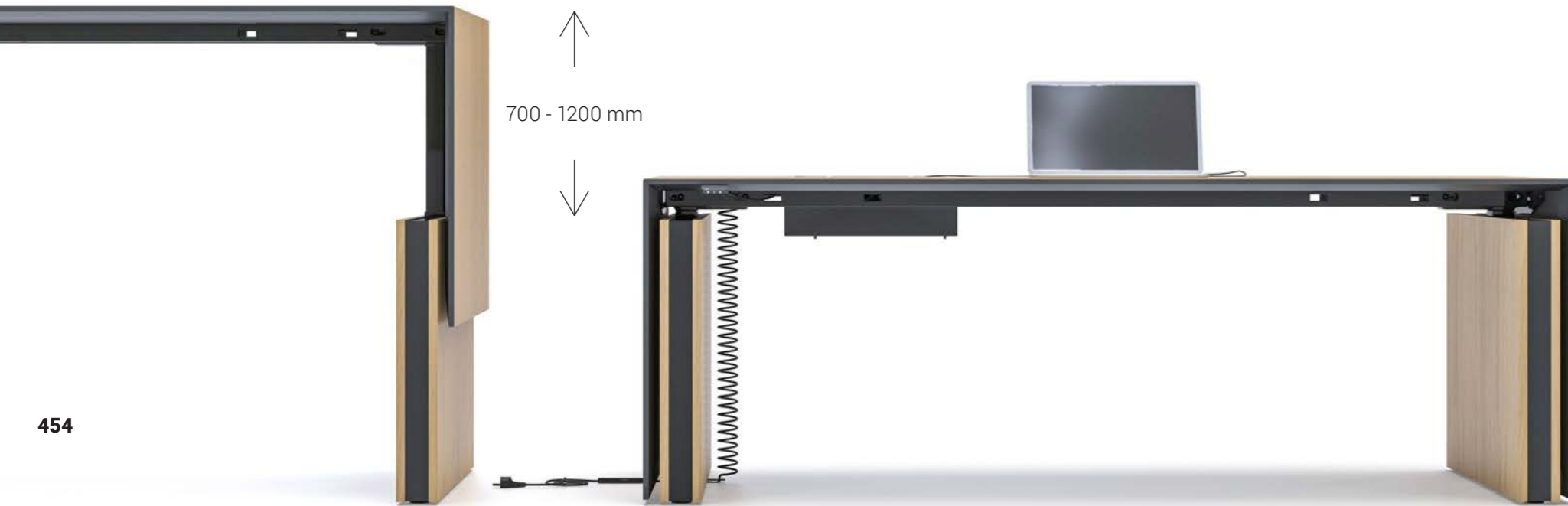

454

↑  
700 - 1200 mm  
↓

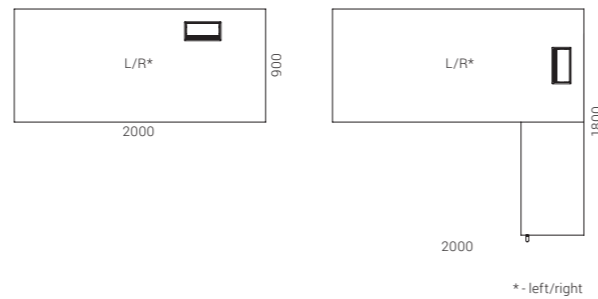

### Reveal your style and individuality

According to your needs, you can choose from two MOTION Executive models: Executive desk made of veneer is designed for those who appreciate naturalness. The top has a subtly chamfered edge, while side panel wraps the desk and makes it look more united and modern. MOTION Executive desk with melamine finish does not have a side panel and looks more simple and modest.



### Obstacle avoidance system

MOTION Executive desk is integrated with a sensitive gyroscope-based anti-collision unit that senses both hard and soft obstacles.

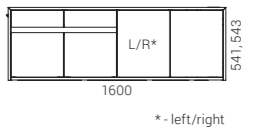

455

### Functional storing

The range consists of several pedestals of different sizes and drawers with or without metal file bars. An easily reachable drawer can be situated in the upper corner of the desk, it is convenient for storing your valuables and can be locked for safety.





A modern collection  
of premium furniture



458

The Italian design of the tables is based on the harmony of straight and curved lines. The elegant three-part curved steel legs are crafted using advanced technology and are the ultimate distinctive feature of the system.

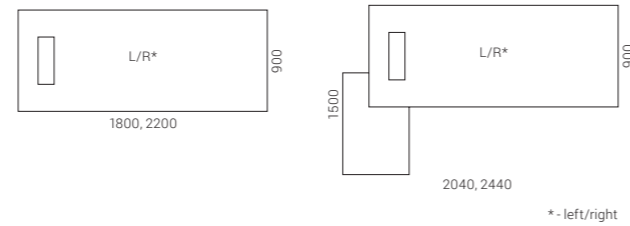

\* - left/right

## Wide range

PLANA tables come with an option of fixed or separate pedestals and many other different storage solutions, such as wardrobes or open shelf units. Modesty panels can be added for a higher sense of privacy, while a table extension can create a space to have meetings right at your desk.

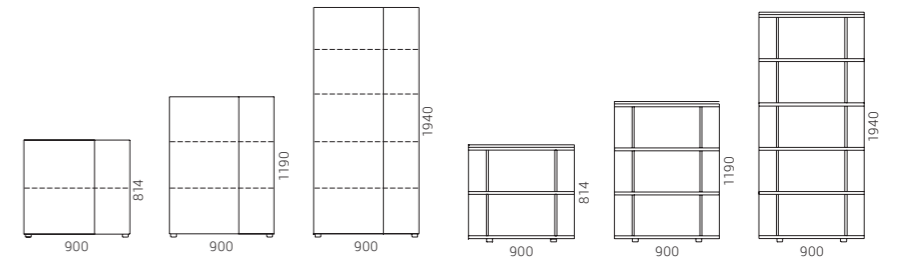
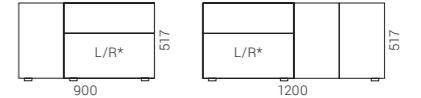

\* - left/right

459

## Quality in the details

The tables come with soft closing grommet, beautifully framed in metal and concealing the box for wire management. PLANA storage features subtle accents such as different panel thickness combinations, lowered top panel.



EXECUTIVE  
FURNITURE

EXECUTIVE  
FURNITURE



PLANA

PLANA

INTERIA  
DISTRIBUTED BY  
PT INTERIA REGALIA NUSANTARA  
hello@by-interia.com

# AIR Executive

Design by Gediminas Juška

> 76  
DESKS

> 114  
CONFERENCE  
& MEETING  
TABLES

## Two thicknesses

The tables are available in two different desktop thicknesses. The solid 120mm desktop gives the table an air of sophistication and will become the focal point of any office. The 25mm desktop is a universal choice for minimalistic offices, its pleasingly simple design will accentuate the unique structure of the legs.

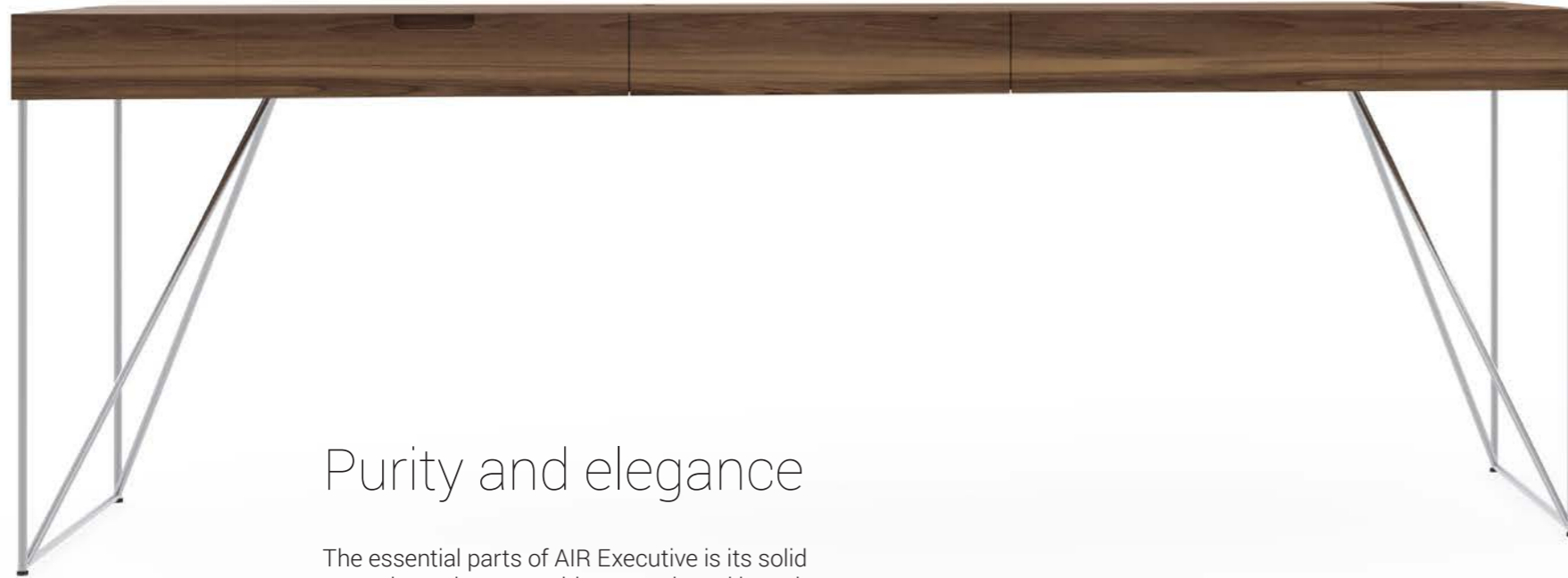

462

## Purity and elegance

The essential parts of AIR Executive is its solid natural wood veneer table top and steel legs that ensure not only the elegant feel of the table, but also its stability. The integrated drawers are lined with high quality natural leather.

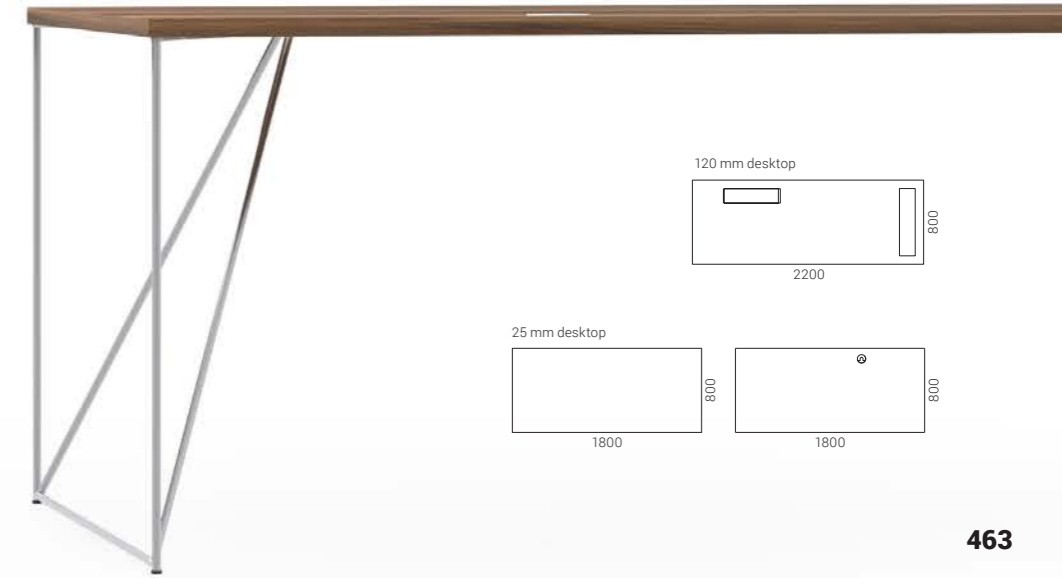

463



## Hidden wiring

Steel table legs are designed in a way that hides all the cable wiring and allows you to keep all the unnecessary items out of your main workspace.



AIR Executive

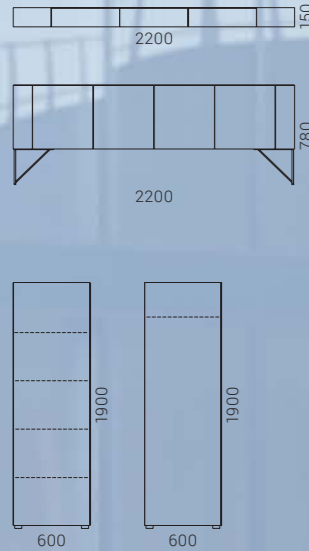

# RECEPTION FURNITURE

466



ICE  
> 468



DOMINO  
> 474



467

NOVA  
> 480



COSY  
> 482



TERA  
> 483

## Minimalistic design

The strict lines of the ICE reception unit create an impeccable shape, suitable for both fancy and ascetic office interiors.

468



## Subtle combinations

Depending on your vision for the interior, choose between a cozy melamine, or a luxurious veneer finish. Various front and top combinations are also available. Using the same finish on the top, base and front will create a solid and minimalistic reception unit, which will be as clean and smooth as ice. On the other hand, introducing a different-coloured top or decorative inserts will allow you to subtly reveal the elegance of this reception unit.

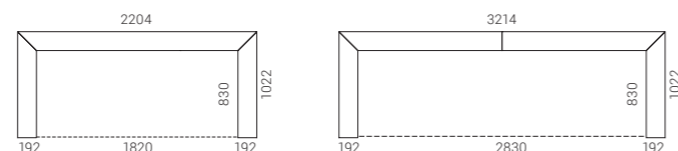

## Ergonomic workspace

The ICE reception unit conforms to the needs of an ergonomic workspace and fits either one or two workstations – a perfect match for NARBUTAS sit-stand or fixed-height desks.

470



471



RECEPTION  
FURNITURE

RECEPTION  
FURNITURE



ICE

ICE

INTERIA  
DISTRIBUTED BY  
PT INTERIA REGALIA NUSANTARA  
hello@by-interia.com

# DOMINO

The rules are simple:  
never stop creating!

DOMINO is a unique piece of furniture that will enable you to create a one of a kind design for your reception in just 4 simple steps. There are no two identical rounds in the game of dominoes, just like there are no two identical DOMINO pieces of furniture!

Easy way to create  
unique reception  
furniture

Firstly, choose the furniture base that suits you best from a range of nine different options. Secondly, combine two thicknesses of exterior panels (18 and 31 mm). Thirdly, choose panels in multiple colours and combine different coatings: upholstery, melamine and natural veneer. Lastly, create your own custom pattern using panels available in 200, 400, 600 and 800 mm sizes.

474

475

DOMINO

DOMINO

**RECEPTION  
FURNITURE**

Cosy atmosphere and  
acoustic comfort

For your DOMINO setup, we recommend using MODUS acoustic screens which will allow you to maintain consistency in your interior style and provide employees with a sense of privacy.

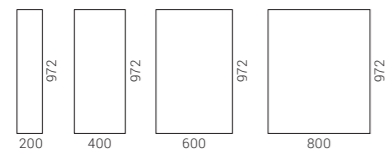

**DOMINO**

**RECEPTION  
FURNITURE**

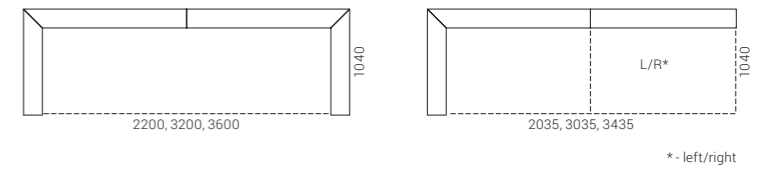

\* - left/right

**477**

Ergonomic workplace

You can create an ergonomic workplace using both regular or sit-stand desks which can be adjusted to a chosen height by employees.

Cable  
management  
solutions

DOMINO reception furniture has all the cable management solutions that are necessary for an ergonomic workplace. Electrical and internet cables will not get in your way and your desk area will be clutter-free and aesthetically pleasing to the eye.



**DOMINO**



SYNERGY  
GS37

SYNERGY  
GS48

SYNERGY  
GS42



480

## Varying forms

Our reception furniture sections are available in different forms. Choose a combination best suited for your office layout.

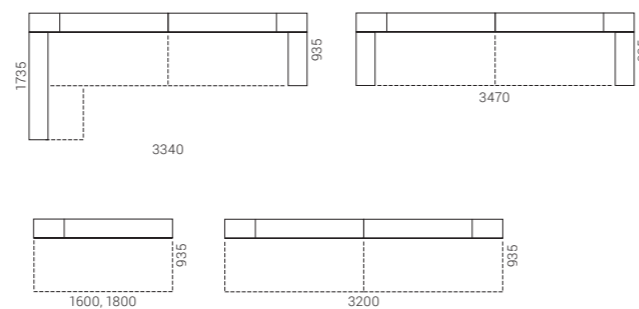

NOVA

## Plexiglas décor

NOVA reception furniture features nice Plexiglas inserts which add a playful touch to these pieces of furniture.

NOVA

# COSY



482

A clean, modern look with no sharp corners on the front side will create a friendly and cosy atmosphere for your visitors. A compact-looking reception is equipped with a 2000mm long table which provides plenty of working space and has many niches for storage. This product also features high-quality impact-resistant materials for better durability.



COSY

# TERA

This modular reception furniture system offers modules in different forms and sizes and is ideal for reception areas of various offices.

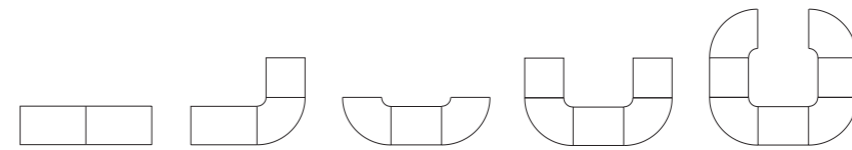

483

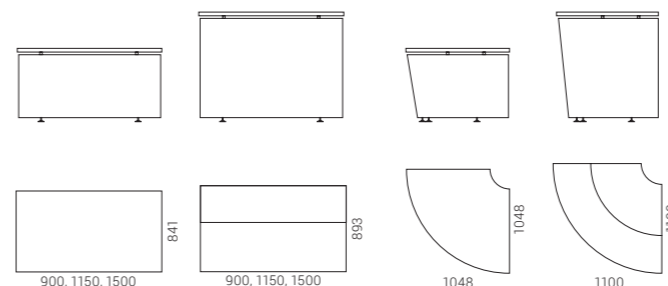

TERA

# CUSTOM-MADE SOLUTIONS

CUSTOM-MADE SOLUTIONS

More room for creativity

Your vision, our solutions. Discover our wide range or go beyond standard. Our technological capacity allows us to produce most of our products with small twists or offer you fully-custom solutions tailored uniquely to your needs.

Customised production can be of two types: modifications to standard products according to specific client needs, or unique design products created and developed to meet clients' vision. A professional team of custom-product engineers and designers work each day on numerous designs, ensuring that the clients' ideas are fulfilled down to the smallest detail, while paying

special attention to the functionality of the furniture and ergonomics.

NARBUTAS has a wide range of production facilities for large-scale production, as well as for small batches of furniture or one-off products. This makes it possible to work with many different materials and produce furniture with curved shapes and metal parts of varying complexity, soft furnishings, and acoustic products. The plant's modern equipment is versatile, so the range of possibilities is extensive.

484



## DESKS AND TABLES

> 486



## SEATING

> 492



## STORAGE

> 488



## RECEPTION FURNITURE

> 494



## ACOUSTIC SOLUTIONS

> 490



CUSTOM-MADE  
SOLUTIONS

# DESKS AND TABLES

## Customisations of standard products

The changes you can make to the product:

- Size;
- The location and shape of the cut-out in the desktop;
- The desktop finish and colour;
- The colour of the desk legs.

## Unique design products

Our technical capabilities allow us to produce exclusive desks, meeting tables or high/bar tables. We can design furniture with different shapes and finishes that are not available in our standard product range.



© Yaidotas Darulis

486

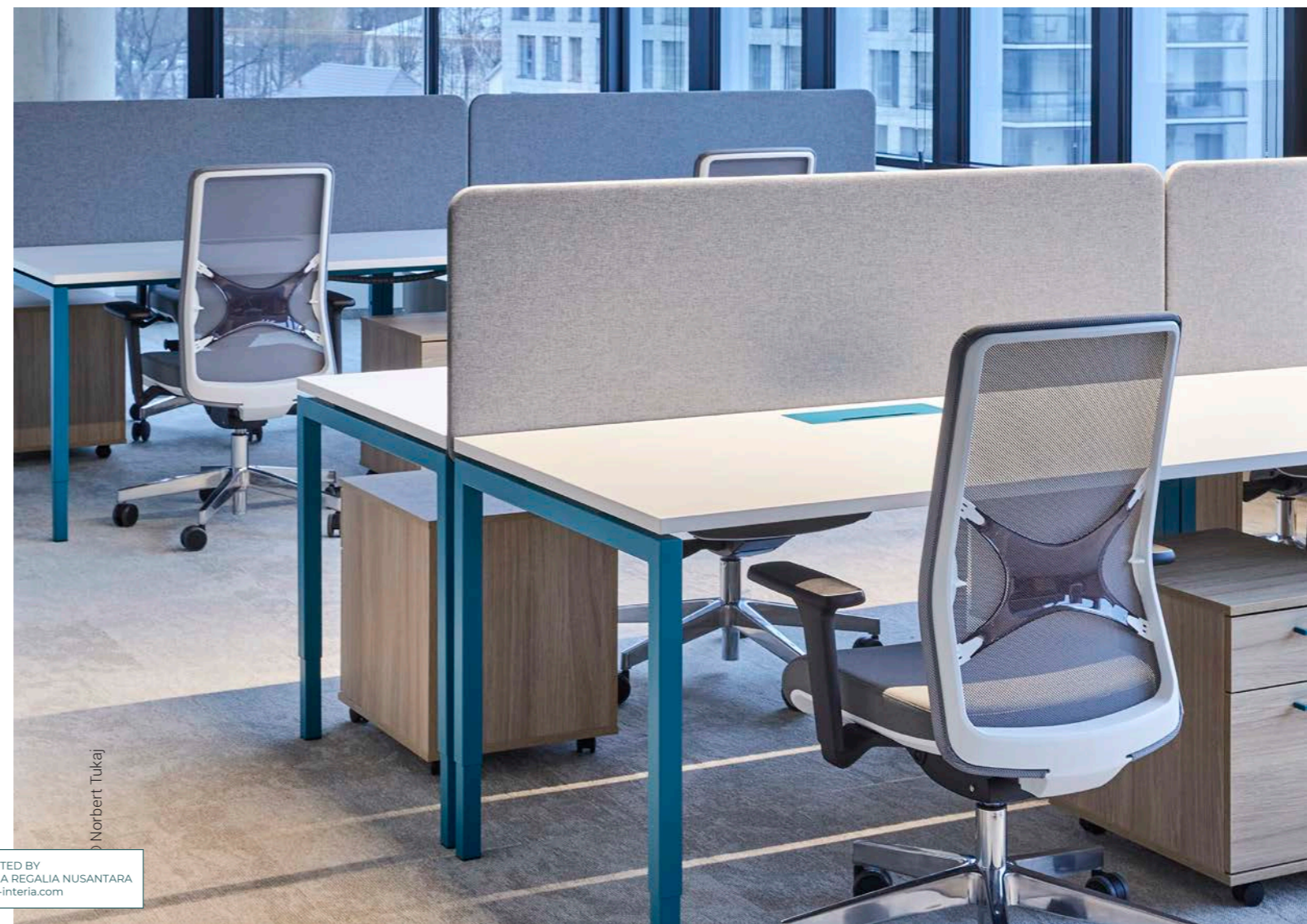

© Norbert Tukaj

# STORAGE

## Customisations of standard products

The changes you can make to the product:

- Size;
- Type and colour of handles;
- Storage unit finish or colour;
- The form of delivery, i.e. you can order an assembled storage unit.

## Unique design products

Storage units often take up a significant amount of space in an office, so it is essential that the furniture is both practical and stylish. Recessed storage solutions with integrated lighting and acoustic panels will create a cosy environment. And recesses with integrated coffee, tea or even ice-cream machines are sure to become a centre of attraction in the modern office.

488

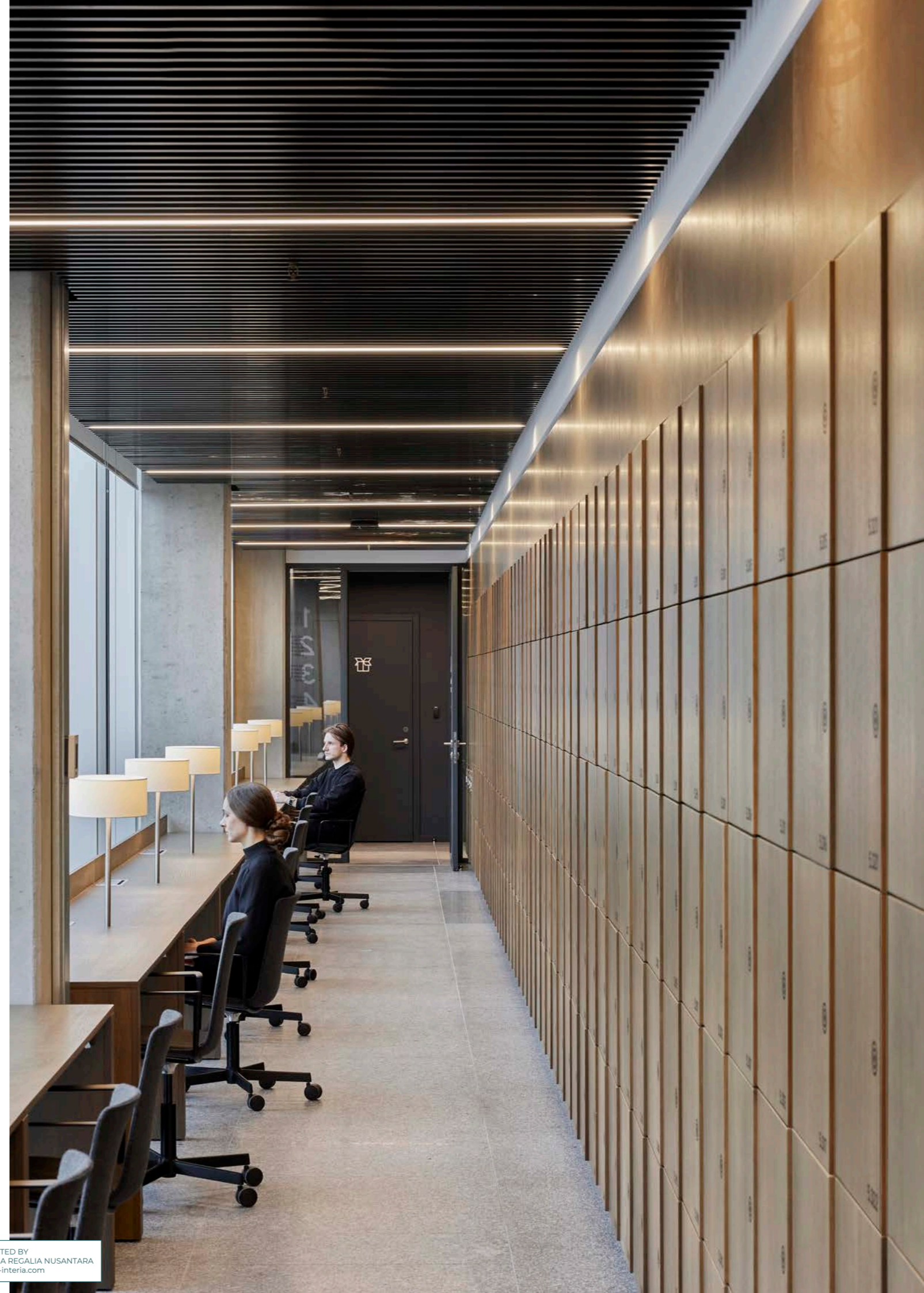

# ACOUSTIC SOLUTIONS

## Customisations of standard products

The changes you can make to the product:

- Size;
- Shape;
- Colour;
- Pattern.

## Unique design products

Taking into account the current trends in office design, we offer a range of acoustic products that are easily adaptable to different offices. The experience we have gained in the development of projects of various complexity evolves into exclusive solutions.

By listening to our customers' expectations, we have developed acoustic pods that have become unique semi-private spaces for individual work or meetings. We can also produce large enclosed acoustic rooms with an additional ancillary space.

490



# SEATING

## Customisations of standard products

Create different looks with NARBUTAS seating. Choose from a wide range of upholstery, artificial and genuine leather collections and shades. We understand that sometimes exclusive interiors require unconventional solutions or shades. That is why we make it possible to choose custom-made upholstery materials.

492



CUSTOM-MADE  
SOLUTIONS

# RECEPTION FURNITURE

Customisations of  
standard products

The changes you can make to the product:

- Size;
- Shape;
- Colour;
- Finish.

Unique design  
products

Customer reception areas usually require customised solutions that can convey the unique image of the company's brand. Thanks to our modern production facility capacities, we can manufacture customised reception furniture with high pressure laminate (HPL), perforated metal or even PET felt finish.

494

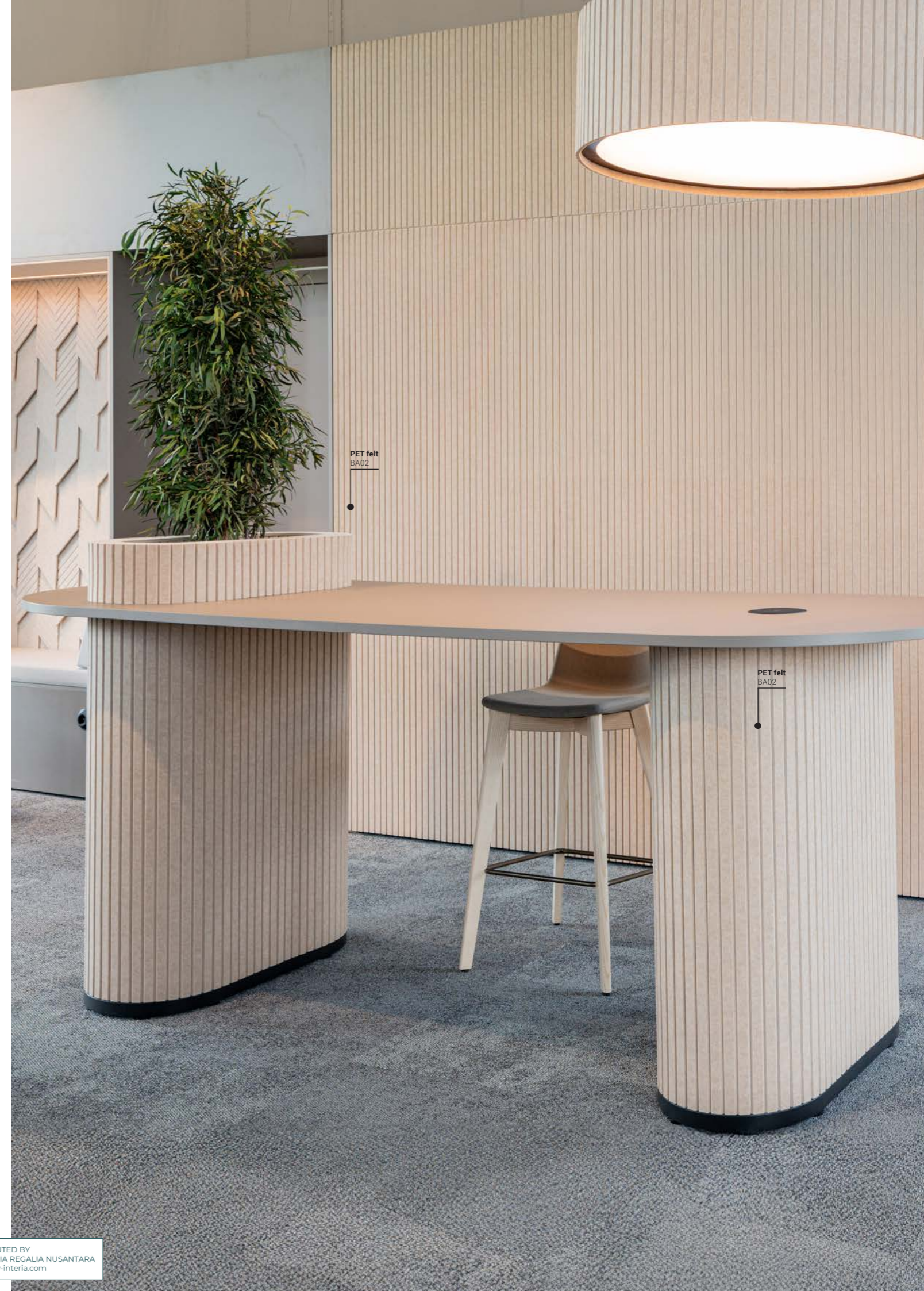
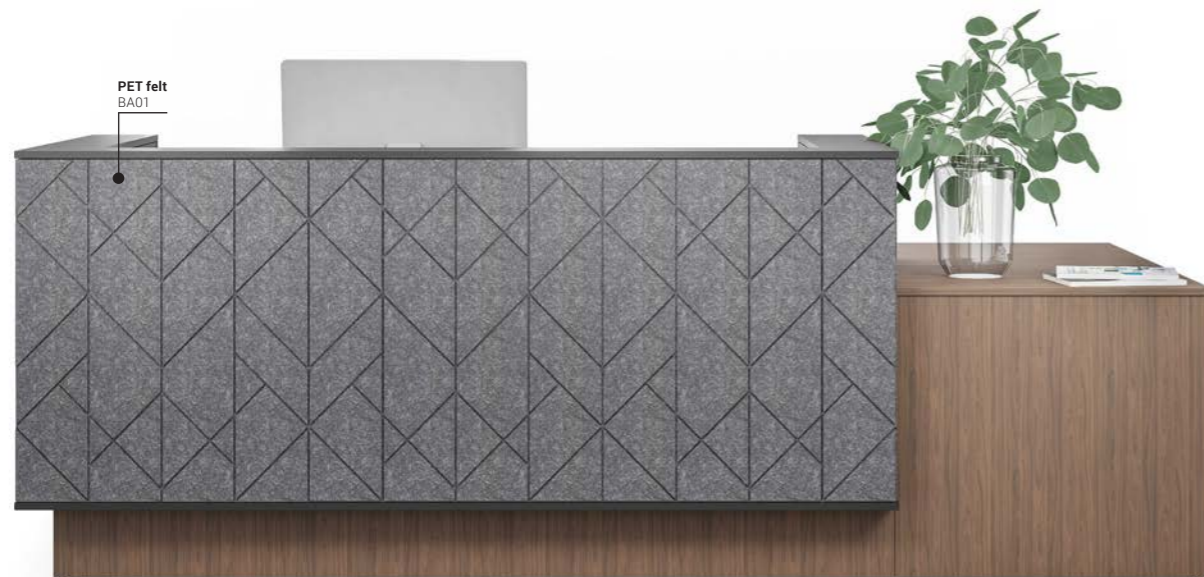

**FINISHES**

Veneer

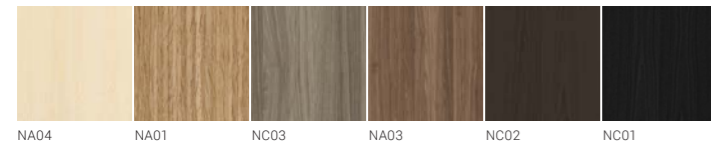

Solid wood

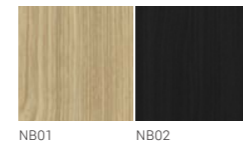

HPL

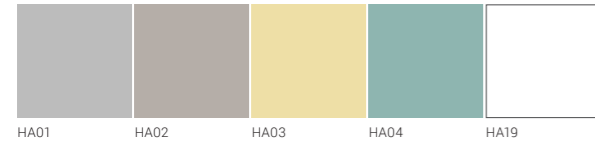

HPL Fenix

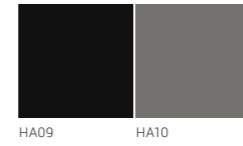

Melamine



496 Plexiglas®

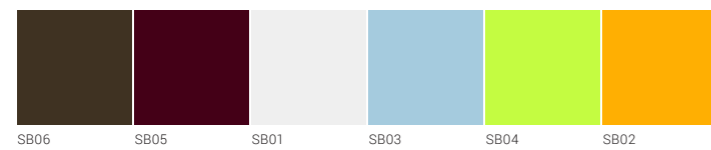

PET felt

100% polyester  
(60% recycled post-consumer, 40% virgin)



Metal

Made from 20-100%  
recycled materials

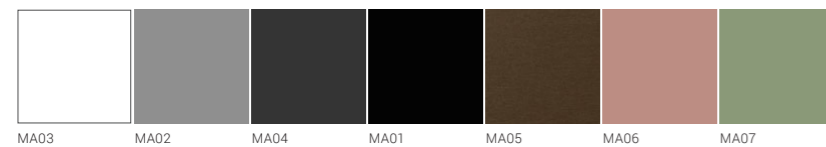

**FINISHES**

Synergy

95% Virgin Wool, 5% Polyamide



Velito | Velito Presto

88% Wool, 12% Polyamide

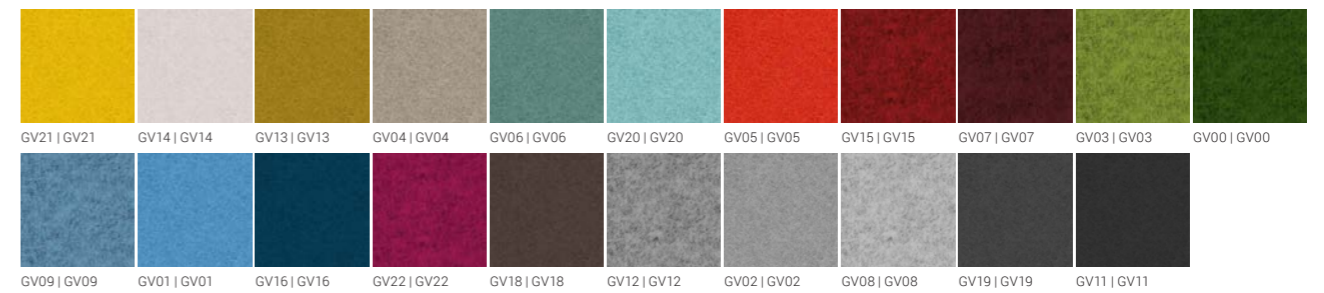

Cyber

100% post-consumer recycled polyester

497



Austea

100% post-consumer recycled polyester



Lucia

100%  
Recycled  
Polyester



Bondai

100% Polyester

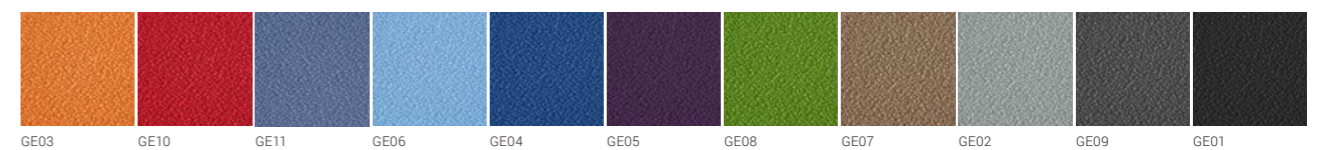

FINISHES

Xtreme Plus

100% Recycled Polyester

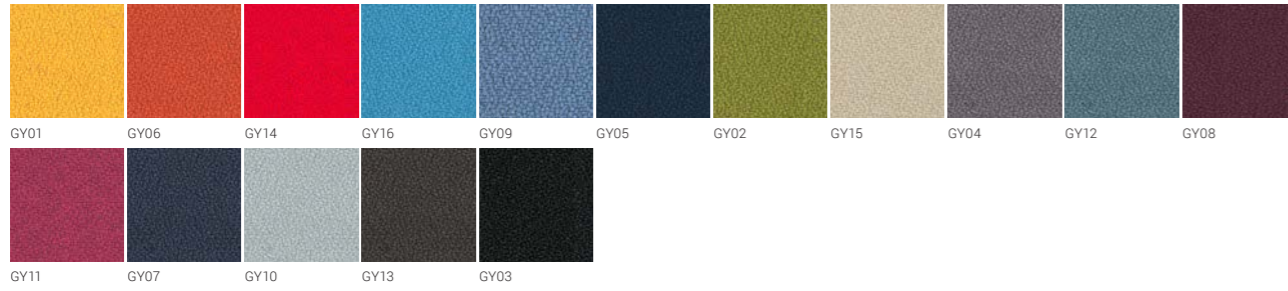

Step | Step Melange

100% Trevira CS® Flame Retardant Polyester

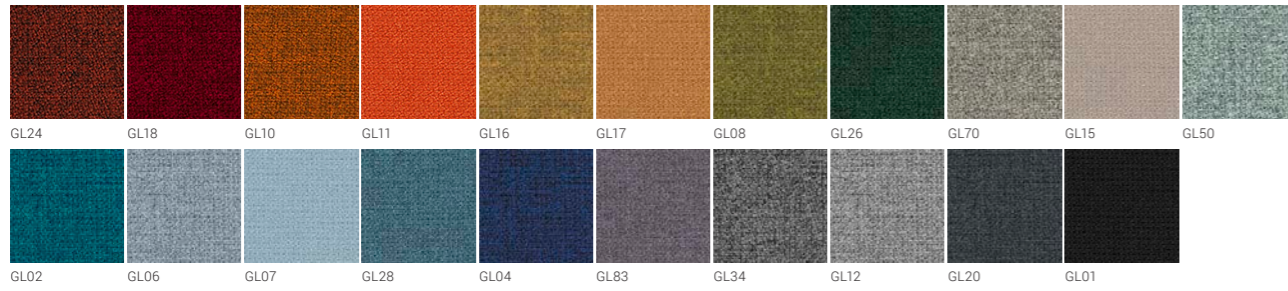

Berta

100% Polyester

498

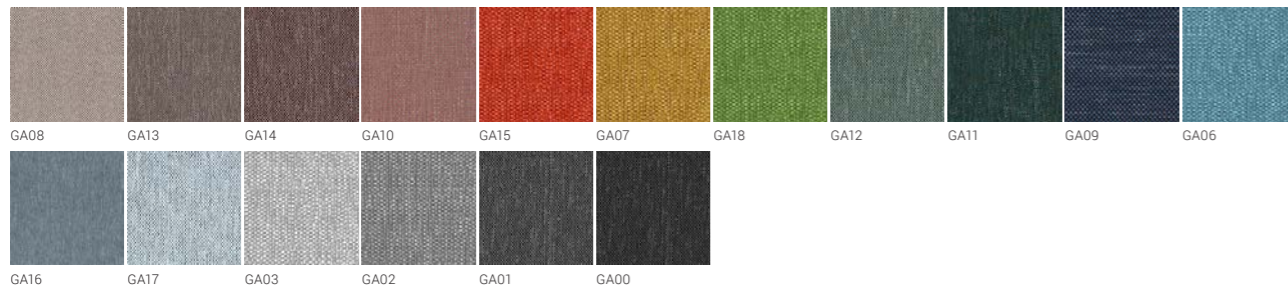

Era

100% Polyester

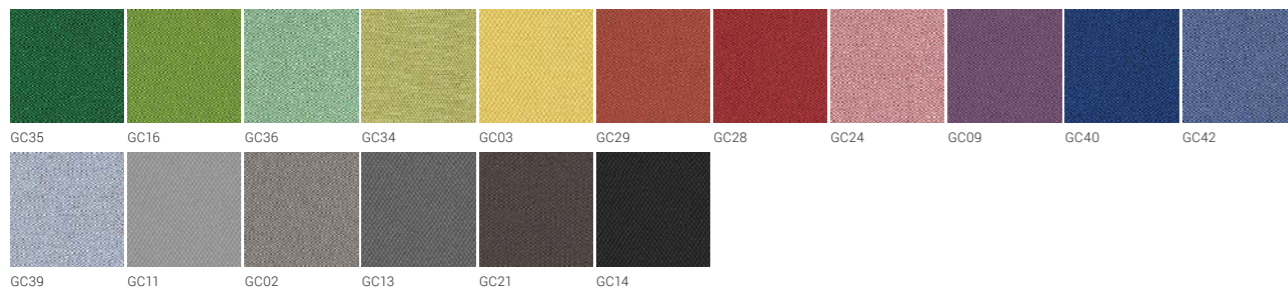

Dream

100% mass-dyed polyester

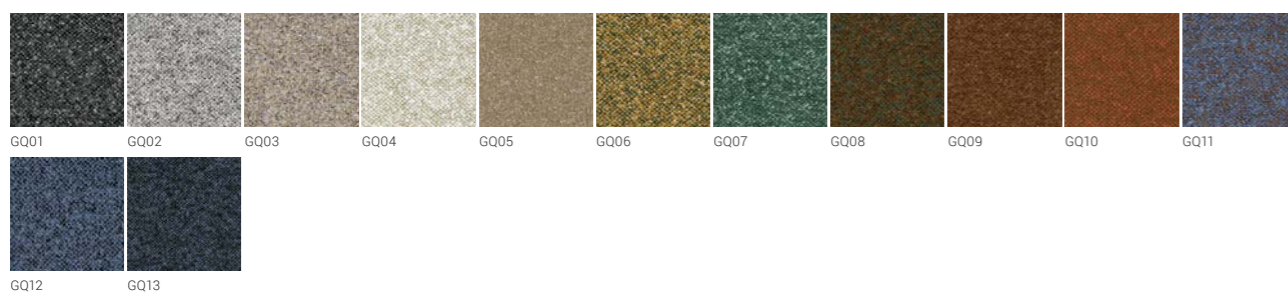

FINISHES

Valencia C5

Vinyl / Urethane Topcoat

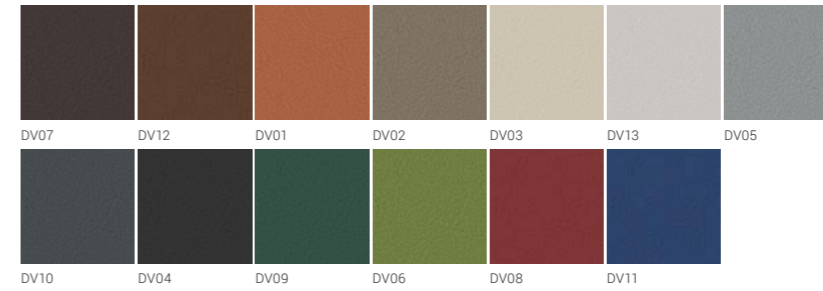

DNN Real leather



RNN

21% PES, 31,5% COT, 47,5% PU



Runner mesh

100% Polyester (20% Recycled Polyester)

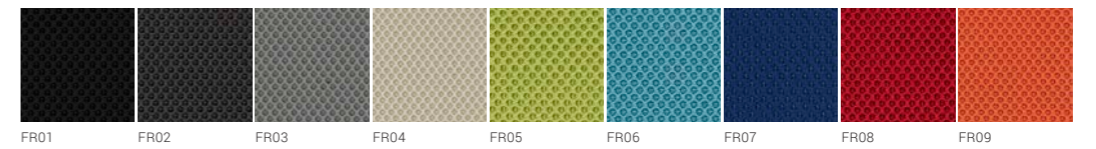

SS Mesh

66% Polyelastomer, 34% Polyester

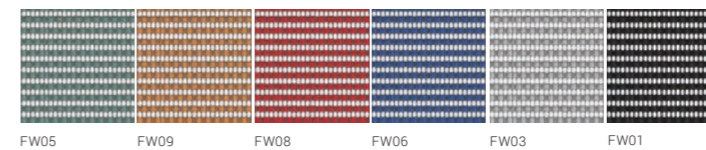

GM

100% Polyester

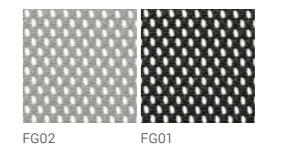

499

Knitted mesh

100% Polyester

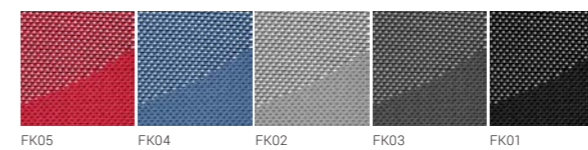

Micro

100% Polyester



PM

70% PVC, 30% PES

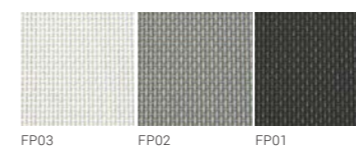

Plastic CANNIE

100% Plastic

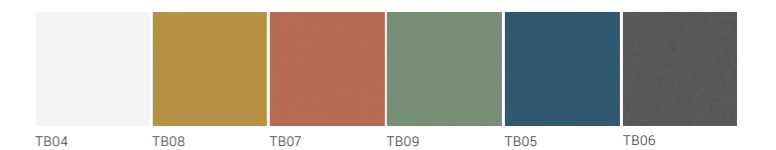

Plastic

100% Plastic

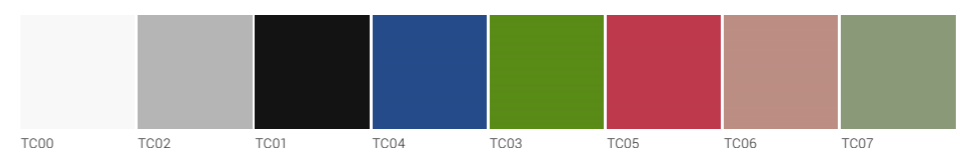

100% Recycled Plastic

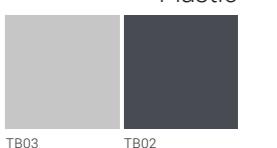

# Definition of icons



## TILT MECHANISM

The backrest and seat base are linked. When user leans back the whole chair tilts.



## KNEE TILT MECHANISM

The backrest and seat base are linked. When user lean back the whole chair tilts. This mechanism allows user to tilt back while the feet remain on the floor, no pressure on the back of the shin.

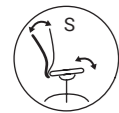

## SYNCHRONOUS MECHANISM

The seat tilting angle is smaller than the tilting angle of the backrest, so that the chair would be more comfortable. This mechanism allows user to tilt back while the feet remains on the floor, no pressure on the back of the leg.



## WEIGHT-SENSITIVE MECHANISM

Mechanism automatically adapts to the user's weight and movement when leaning back.



## TENSION ADJUSTMENT

This adjustment allows user to control the rate and ease with which the chair reclines for different weights and strengths.



## LOCKING POSITIONS

The backrest of the chair has multiple locking positions with different angles for comfortable working, reading or resting.

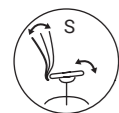

## BACKREST TRAVEL LIMITATION

The backrest travel is limited to 3 positions with back locking in the upright work position.

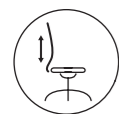

## BACKREST HEIGHT ADJUSTMENT

The backrest height can be individually adjusted according to the height of the user.



## SLIDE SEAT

This adjustment helps the user to regulate the distance between the backrest and front edge of then seat, thus providing optimum support for the upper thighs. Correctly adjusted seat depth helps user to maintain proper back support, while distributing the weight evenly across the seat cushion.

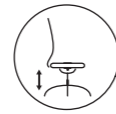

## PNEUMATIC HEIGHT REGULATION

This adjustment allows the user to change the height of the seat. Pneumatic mechanism uses pressurized air to lift or lower the seat.

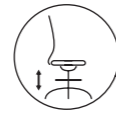

## HEIGHT ADJUSTABLE FOOTRING

The footring of the chair can be adjusted in height for the comfortable position of user's feet and legs without depending on the chair height position. It helps to maintain a correct seating position and avoid unpleasant back and neck pain.

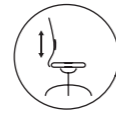

## ADJUSTABLE LUMBAR SUPPORT

The lumbar support can be adjusted in height and depth (depending on the chosen chair type). Adjustable lumbar support can be adapted to user's individual curve of the spine. It helps to reduce the muscle strain and protect from the back pain.



## LUMBAR SUPPORT

The lumbar support is mounted into the backrest and helps to reduce the muscle strain.



## HEADREST

This additional part of the task chair helps to reduce tension in your neck muscles, provides support and comfort to the head and neck while in a reclined position.



## ADJUSTABLE ARMRESTS

Depending on the chair type armrests are adjustable in two, three or four directions (2D, 3D, 4D): height, width, the pad moves forwards and backwards or is rotatable. Height adjustment takes the strain off the neck muscles. Width adjustment and rotation allows the user to position the armrest in proper distance from the body and helps finding the most comfortable support angle.



## WRITING TABLET

Rotatable. It allows users to put their notebooks, laptops or tablets upon.



## STACKABLE

Chairs can be easily stacked one onto another. Therefore, they are perfect for offices with low storage space.



## CONNECTORS

Allow linking chairs in orderly rows.

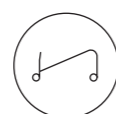

## TROLLEY

By using the trolley, you can easily store or move stackable chairs from one place to another.

narbutas

500

Work with us

archello ARCHITONIC CONFIGURA pCon PLANNER

MRL MY RESOURCE LIBRARY V R A S Q A

Connect with us



Scan and find all useful links

© "Narbutas International", 2025

UAB "Narbutas International" reserves the right to change product information in this catalogue without prior notice.

