

# cmd.

Connecting Seamlessly



INTERIA

DISTRIBUTED BY  
PT INTERIA REGALIA NUSANTARA  
[hello@by-interia.com](mailto:hello@by-interia.com)

# Contents

## ABOUT

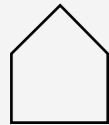

CMD are the UK's largest manufacturer of desk based electrical products and power distribution products for the commercial office environment in the UK, used in some of the most high-profile commercial office, retail and hospitality spaces. Alongside our market leading products, we also have an expert team of workplace specialists, able to provide you with best practice advice and guidance to ensure compliance with BS 6396, BS7671 and DSE (display screen equipment) requirements.

London Showroom	3	Bespoke Design Solutions	11
Why CMD	5	Sustainability - Net Zero	13
Solutions for every workplace	7		
How CMD can help you	9		

## WORKSTATION POWER



A selection of on-desk, in-desk and under-desk power modules, with a range of socket options, to meet the requirement of any workstation application.

About workstation power	15	Inca	27	Reveal	37
Capsule	17	Neptune	29	Surface/Face	39
Caplet	19	Lunar	31	Affinity	41
Contour	21	Porthole 65	33	Conti	43
Linear	23	Connect	35	Elite+	47
Harmony	25				

## MONITOR ARMS



Both articulated and pole supports available for single and double configurations to enable the ergonomic positioning of each screen.

About monitor arms	51	Reach Plus	57	Active	63
Miro	53	Vision S	59	Miro - design innovation	65
Reach HD	55	Vision HD	61	Anatomy of a monitor arm	67

## WORKSTATION ESSENTIALS



A variety of products to complete your workstation, which include cable spines, cable baskets and desk grommets.

About workstation essentials	69	Cableway	75	Grommets	81
Tidy	71	Fusion	77		
Spiral	73	Premium	79		

## POWER DISTRIBUTION

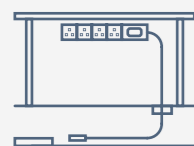

A full range of connectivity from powertrack and power hub power distribution systems to floor boxes or access grommets that bring the power to the user via a range of under desk, in desk, or on desk power modules.

About power distribution	83	Slab Boxes	93
Betrak®	85	Cable Hives	95
Power Hub	89	Cable Grommets	97
Floor Boxes	91	Rotasoc®	99

## London Showroom

View our range of exciting products and innovations. You are welcome to drop in anytime either by appointment or otherwise, where you will be guaranteed a warm welcome.

- 3 BALTIC STREET EAST  
LONDON, EC1Y 0UJ

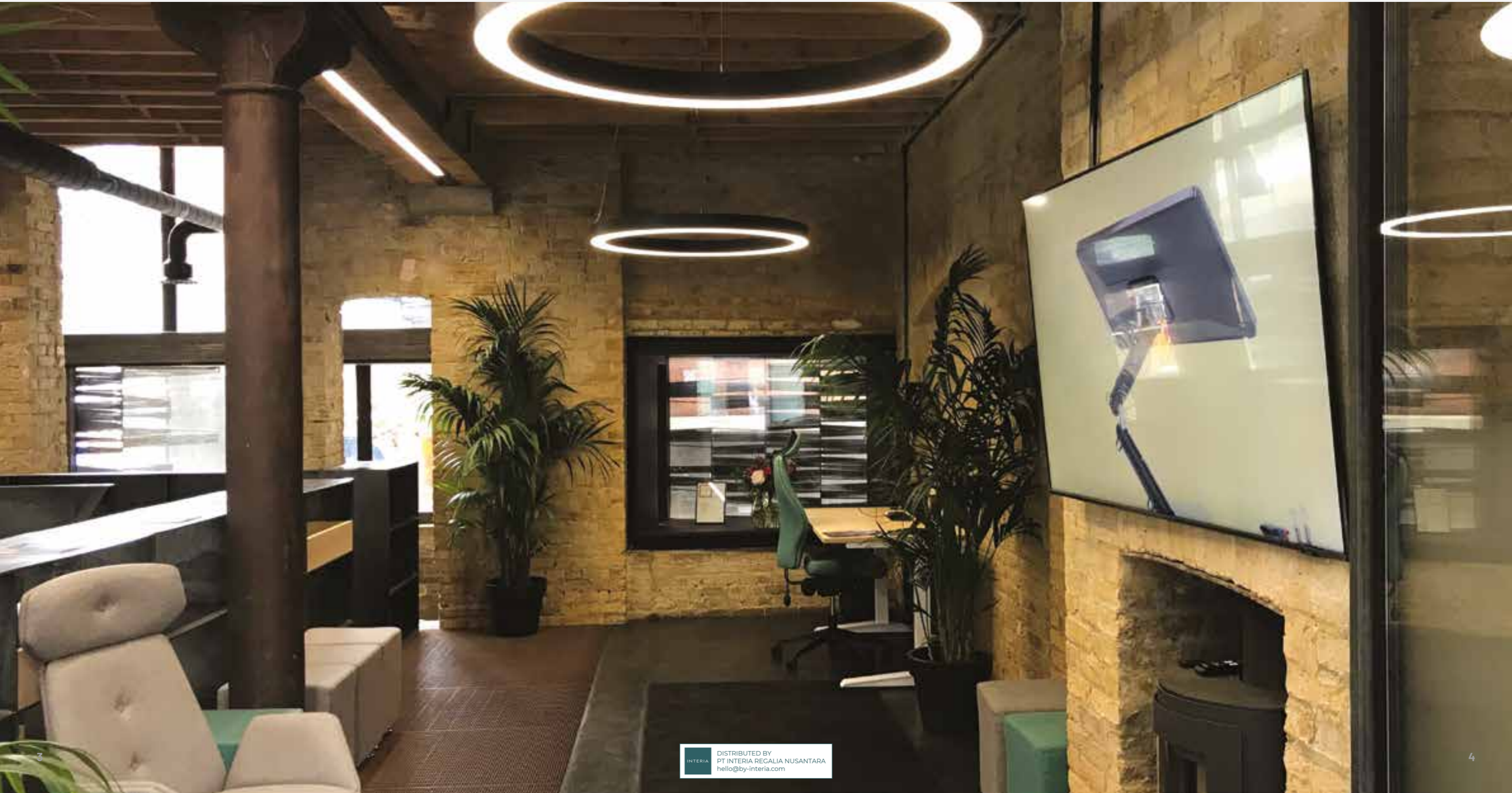

## Why CMD

For over 40 years our quality products have been specified in some of the World's most prestigious commercial interior and office spaces, reflecting our commitment to design and operational excellence.

- QUALITY PRODUCT  
AND WARRANTY

- ENVIRONMENTAL  
RESPONSIBILITY



## Solutions for everyday workspaces

We help you create healthier workplaces with products that look good, are simple to install, improve performance, and are built to last.

- WORKSTATION POWER

- MONITOR ARMS

- WORKSTATION ESSENTIALS

- POWER DISTRIBUTION



## How CMD can help you

A few reasons why CMD is the ideal partner to help your business and end-users thrive - no matter the workspace.

- KNOWLEDGE AND EXPERTISE

- BESPOKE DESIGN SOLUTIONS

- SHORT LEAD TIMES

- EXCELLENT CUSTOMER SERVICE



## Bespoke Design Solutions

CMD prides itself on being a Solution Provider. In addition to providing power distribution systems, workstation power, monitor arms and office essentials from our standard range, we also provide a comprehensive 'Bespoke Solution' service, incorporating Power, Data, AV & ergonomic components in a wide range of unique and innovative configurations.

- BESPOKE DESIGN TO SUIT CLIENTS' INDIVIDUAL NEEDS

- DEVELOPING STANDARD FURNITURE AND POWER DISTRIBUTION PRODUCTS

- ASSISTING WITH TECHNICAL QUERIES AND INFORMATION REQUESTS

- PRODUCT VISUALISATION



## Sustainability at CMD - Net Zero

To facilitate the creation of sustainable solutions, CMD takes responsibility for the entire process - from joined-up design to smart reuse. It all starts with the drawing board and the choice of raw materials, based on our ethos that eco-friendly materials and high-quality products trigger a positive chain reaction for the planet.

- MIRO MONITOR ARM

- BETATRAK POWERTRACK  
POWER DISTRIBUTION SYSTEM

- FLOOR BOXES

- ROTASOC WORKSTATION  
POWER SYSTEM



## Workstation Power

A comprehensive range of on-desk and in-desk workstation power and AV/data modules. On-desk modules allow for easy access for when you're working, in-desk modules are ideal for conference rooms and communal areas.

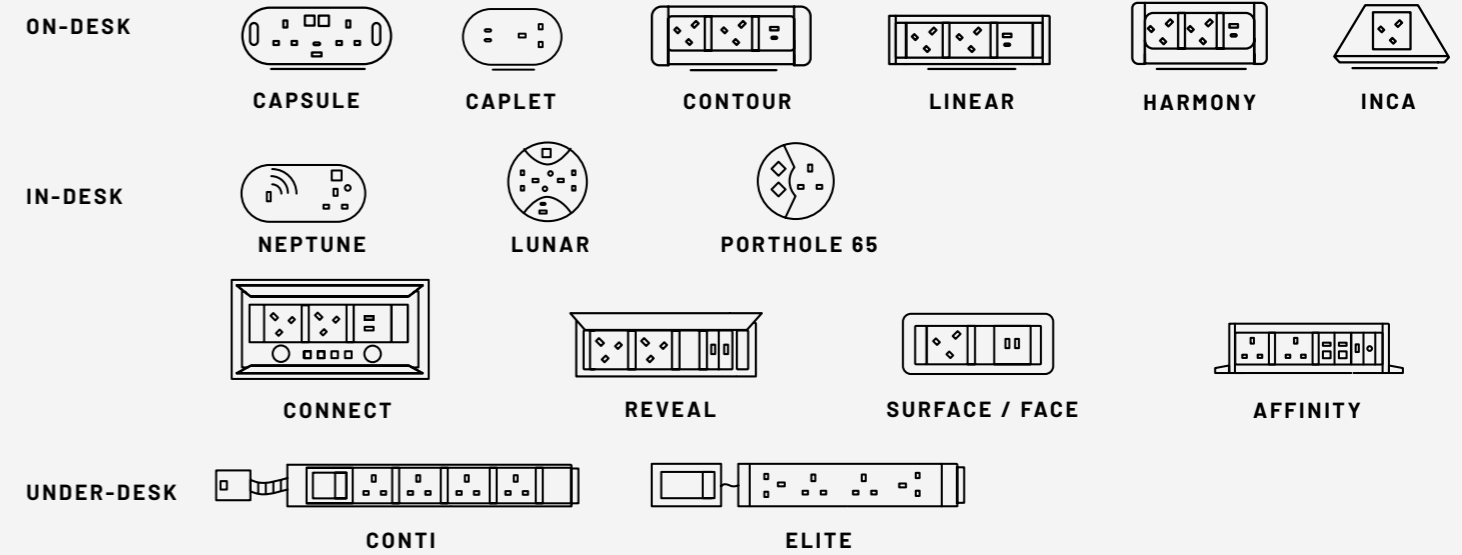



## Capsule and Capsule Plus

A fixed format on-desk power module offering 2x UK sockets with individual neon switches, resettable 3A circuit breakers and a dual port type A and C adaptive fast charger with a maximum PD65W for charging laptops, tablets and smart phones.

### OVERVIEW

- PD65W or PD18W type A and C twin port USB adaptive charger with LED indicators
- 2x UK sockets with individual on/off switches with LED indicators
- 2x 3A resettable circuit breakers
- 2x Keystone blanks that can be replaced with a range of keystone couplers
- Supplied with c-clamp fixing to fit desk thicknesses between 11mm and 30mm
- Available in black or white

Capsule is also available in a Schuko version with 2x Schuko sockets, but without switches or re-settable circuit breakers.

### TECHNICAL INFORMATION

#### Capsule Options



### DIMENSIONS

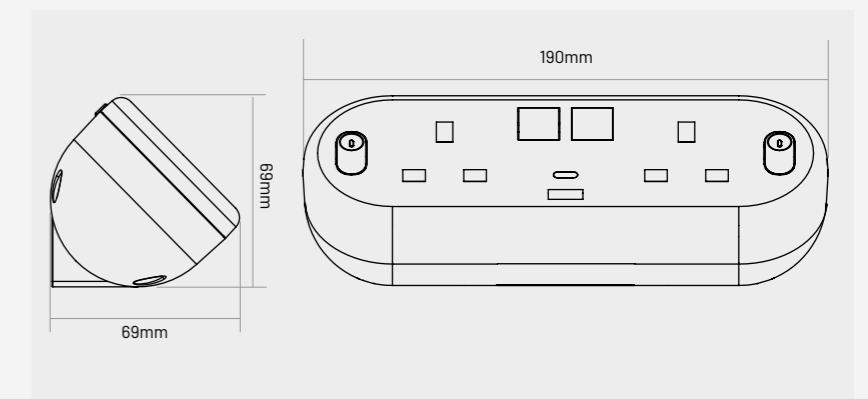

# Caplet

A neat and vibrant on-desk power module with a UK socket and a dual port type C adaptive fast charger, with a maximum 65W, for charging high powered laptops, tablets and smart phones.

## OVERVIEW

- Twin USB Type C adaptive fast charger
- 1x UK socket
- 1x 3A resettable circuit breaker
- Fitted with 1.5m cable to 3-pole GST male connector (starter lead sold separately)
- Supplied with c-clamp fixing to fit desk thicknesses between 11mm and 30mm
- Available in black and white, and a range of colours\*

## TECHNICAL INFORMATION

### Caplet Options

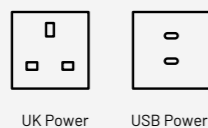

## DIMENSIONS

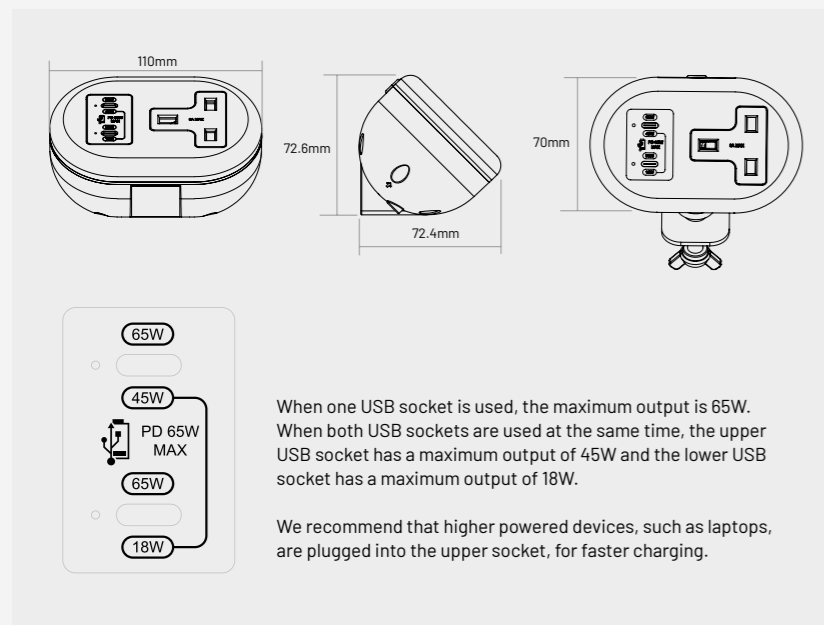

\*subject to minimum order quantities



## Contour

A customisable on-desk power module with a choice of UK, Schuko, French/Belgian, Italian or Swiss socket, a USB type A 18W charging socket and a USB type C 65W adaptive fast charging socket. The stylish body can be supplied in either anodised aluminium or plastic, and you have a choice of black, white or grey plastic body and end-cap options to select from.

### OVERVIEW

- A choice of UK, Schuko, French/Belgian, Italian, or Swiss socket
- USB Type A 18W quick charging socket and USB Type C 65W adaptive fast charging socket
- UK Sockets are individually fused at 3.15A or 5A
- Schuko sockets are shuttered and un-fused
- A choice of desk c-clamp or adhesive fixing kit
- Available in black, white or silver

### TECHNICAL INFORMATION

#### Contour Options

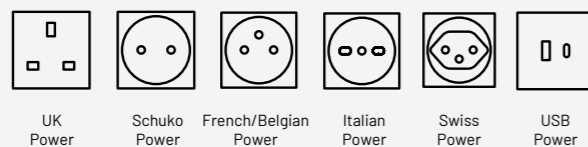

UK Power

Schuko Power

French/Belgian Power

Italian Power

Swiss Power

USB Power

### DIMENSIONS

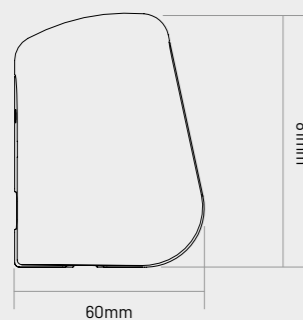

**Customisable variants available.**

Please speak to your Account Manager for more information.





## Linear

A customisable on-desk power module that can house UK and international, USB charging and AV sockets. The stylish body can be supplied in anodised aluminium and you have a choice of black, white or grey plastic body and end-cap options to select from.

### OVERVIEW

- A choice of UK and international power, USB charging and data/AV sockets
- UK Sockets are individually fused at 3.15A or 5A
- Schuko sockets are shuttered and un-fused
- A choice of desk c-clamp or adhesive fixing kit
- Available in black, white or silver

### TECHNICAL INFORMATION

#### Linear Options



Switch UK Power Schuko Power USB Power Data/AV

### DIMENSIONS

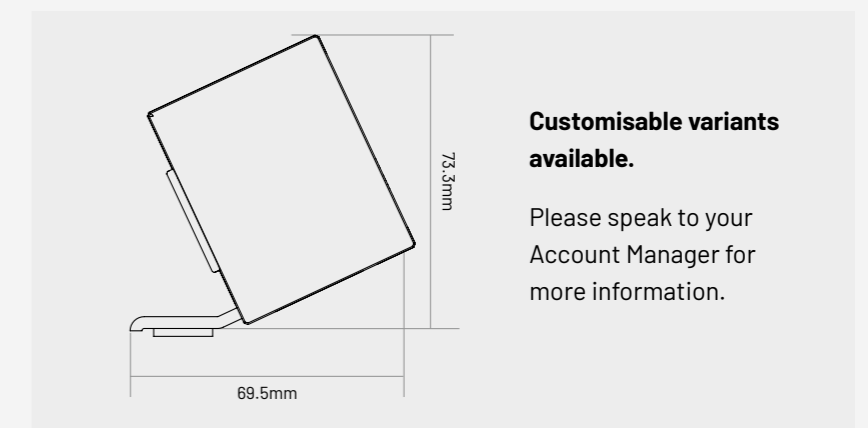

**Customisable variants available.**

Please speak to your Account Manager for more information.



## Harmony

A customisable on-desk power module that can house UK and international, USB charging and AV sockets. The stylish body can be supplied in anodised aluminium and you have a choice of black, white or grey plastic body and end-cap options to select from.

### OVERVIEW

- A choice of UK and international power, USB charging and data/AV sockets
- UK Sockets are individually fused at 3.15A or 5A
- Schuko sockets are shuttered and un-fused
- A choice of desk c-clamp or adhesive fixing kit
- Available in black, white or silver

### TECHNICAL INFORMATION

#### Harmony Options



Switch



UK Power



Schuko Power



USB Power



Data/AV

### DIMENSIONS





## Inca

Inca has been designed specifically for communal areas and meeting rooms. This stylish power and USB charging module is available in black, grey and white and has four faces that can be configured in a variety of ways to meet the power needs of any working environment.

### OVERVIEW

- Inca has 4 usable faces offering a wide range of configurations for power and USB charging
- 1m mains lead to 3 pole connector
- Requires a separate mains lead if connected directly to a wall or floor socket
- Available as a freestanding on desk module or can be fixed using a simple grommet hole fixing
- Available in black, white or grey

### TECHNICAL INFORMATION

#### Inca Options



### DIMENSIONS

#### Customisable variants available.

Please speak to your Account Manager for more information.

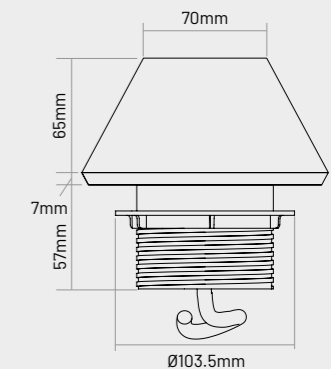
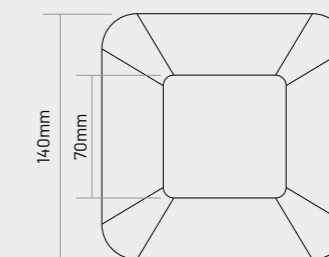



## Neptune

A fixed format in-desk power module offering 15W wireless charging, 1x UK socket, resettable 3A circuit breaker and a dual port type A and C adaptive fast charger with a maximum PD65W for charging laptops, tablets and smart phones.

### OVERVIEW

- PD65W type A and C twin port USB adaptive charger
- 1x UK socket
- 1x 3A resettable circuit breaker
- 15W wireless charger for charging a range of mobile devices
- 1x Data blank that can be replaced with a range of keystone couplers
- Can be fitted to a standard 80mm grommet hole to fit desk thickness up to 60mm
- Available in black or white

### TECHNICAL INFORMATION

#### Neptune Options



USB Power



UK Power



Data/AV

### DIMENSIONS

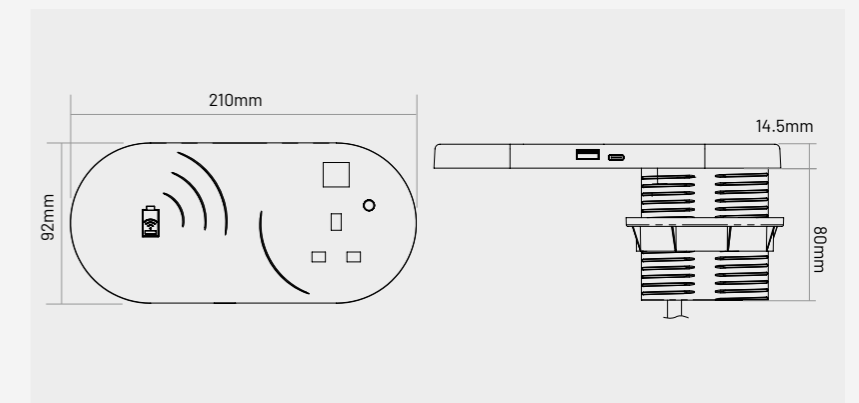

# Lunar

A fixed format in-desk power module offering 2x UK socket, 2x resettable 3A circuit breakers and a dual port type A and C adaptive fast charger with a maximum PD65W for charging laptops, tablets and smart phones and a data keystone port that can be used with a range of data keystone couplers.

## OVERVIEW

- PD65W type A and C twin port USB adaptive charger
- 2x UK socket
- 2x 3A resettable circuit breaker
- 1x Data blank that can be replaced with a range of keystone couplers
- Can be fitted to a standard 127mm grommet hole to fit desk thicknesses between 13mm and 50mm
- Available in black or white

## TECHNICAL INFORMATION

### Lunar Options

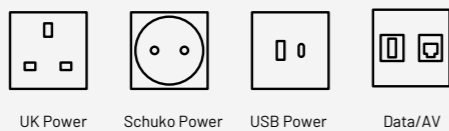

UK Power Schuko Power USB Power Data/AV

## DIMENSIONS

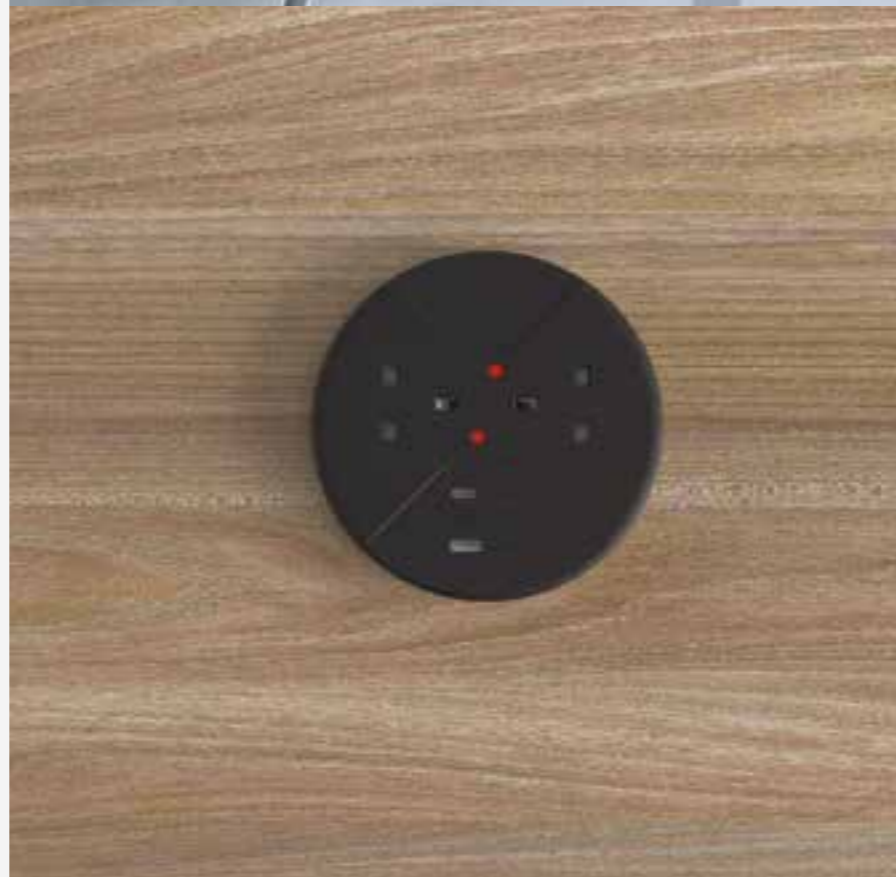
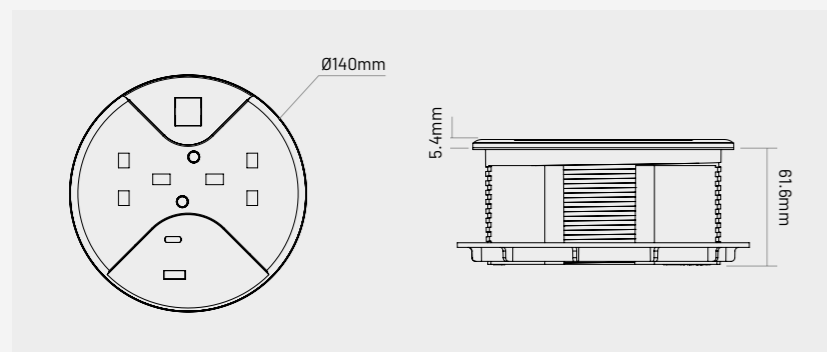



## Porthole 65

Porthole 65 is a fixed format power module designed for workstations and meeting tables, and fits into a standard 80mm grommet hole. It comes with a choice of UK, Schuko, French/Belgian, Italian or Swiss socket, a USB type A 18W charging socket and a USB type C 65W adaptive fast charging socket. It can charge a range of leading laptops, tablets and smart phones. It's discreet low profile blends seamlessly with your furniture, and provides the perfect workstation, and collaborative power solution for offices and commercial spaces.

### OVERVIEW

- A choice of UK, Schuko, French/Belgian, Italian or Swiss socket
- USB Type A 18W quick charging socket and USB Type C 65W adaptive fast charging socket
- Fitted with 1.5mm cable to 3-pole GST mal connected (starter lead sold separately)
- Supplied with a hand fixing nut, to secure the module to a standard 80mm grommet hole (for desk thicknesses between 12mm and 42mm)
- Available in black, white and grey

### TECHNICAL INFORMATION

#### Porthole Options

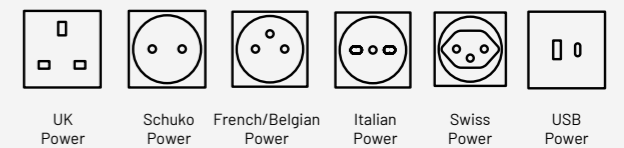

### DIMENSIONS

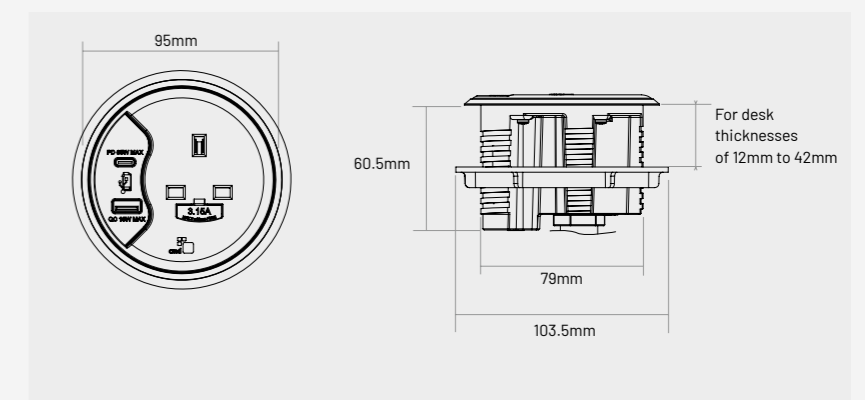

## Connect

A customisable in-desk power module that can house UK and international, USB charging and AV sockets - perfect for Conference and Meeting spaces. The dual lid design can be fully closed when in use, providing a clean aesthetic. Connect can blend in to any workspace and is available in black, white or grey.

### OVERVIEW

- Discreet profile with dual opening lid with brush strip
- USB-C 18W and USB-A 12W (30W total output)
- 4x customisable keystone cut-outs to suit your needs
- 2x data capture bushes
- Dual lid design can be fully closed when in use
- Available in black, white or grey

### TECHNICAL INFORMATION

#### Connect Options

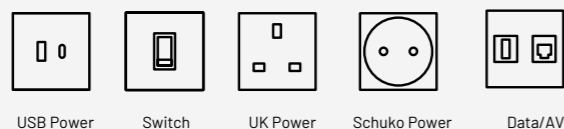

### DIMENSIONS

**Cut out A (up to 4 sockets/USB chargers + 4 keystones):**  
303mm x 144mm (19mm to 30mm desktop thickness)

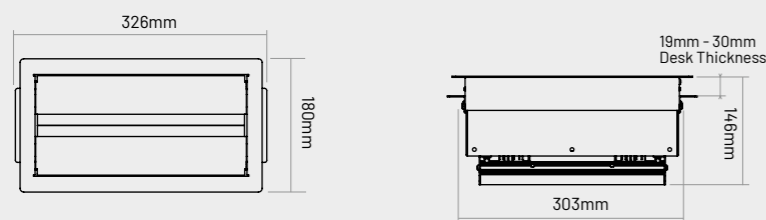

**Cut out B (up to 6 sockets/USB chargers + 4 keystones):**  
443mm x 144mm (19mm to 30mm desktop thickness)

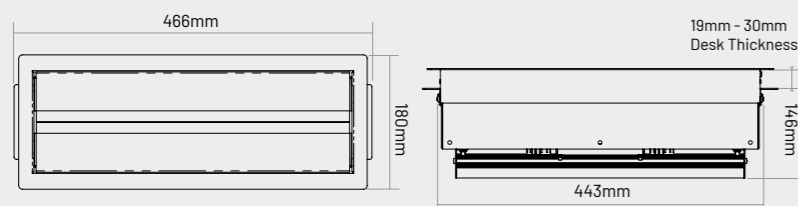

## Reveal

A customisable in-desk power module that can house UK and international, USB charging and AV sockets. The stylish body can be supplied in a choice of black, white or grey.

### OVERVIEW

- A choice of UK and international power, USB charging and data/AV sockets
- UK Sockets are individually fused at 3.15A or 5A
- Schuko sockets are shuttered and un-fused
- A cutting template is available to ensure the module fits securely into the desk surface
- Available in black, white or silver

### TECHNICAL INFORMATION

#### Reveal Options

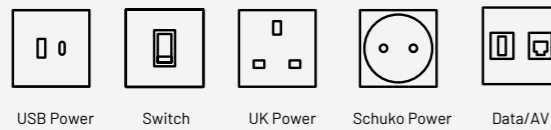

### DIMENSIONS

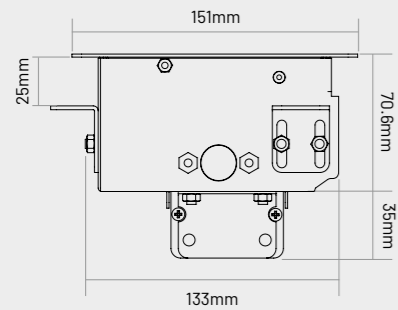

**2 different variants are available.**

Please speak to your Account Manager for more information.



## Surface / Face

A customisable in-desk power module that can house UK and international, USB charging and AV sockets. The stylish body can be supplied in a choice of black, white or silver.

### OVERVIEW

- A choice of UK and international power, USB charging and data/AV sockets
- UK Sockets are individually fused at 3.15A or 5A
- Schuko sockets are shuttered and un-fused
- A cutting template is available to ensure the module fits securely into the desk surface
- Available in black, white or silver

### TECHNICAL INFORMATION

#### Surface/Face Options



USB Power



Switch



UK Power



Schuko Power



Data/AV

### DIMENSIONS

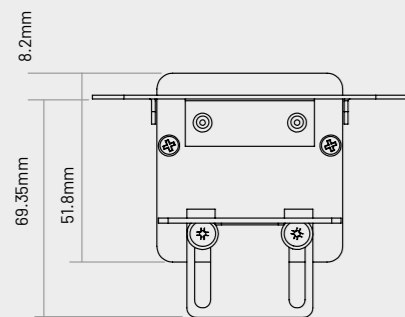

**4 different variants are available.**

Please speak to your Account Manager for more information.





## Affinity

Affinity module offers the convenience of power and data at the desktop when you need it and an uncluttered work surface when you don't. It is a concealed unit that can function in the open or closed position.

### OVERVIEW

- All UK power socket versions feature individual fuses
- Lateral fuses with a choice of 3.15A or 5A to comply with BS 6396:2008
- Power and data cables all exit from under the side of the unit
- Designed to fit desk thicknesses ranging from 10mm to 50mm
- Available in grey fascia end caps and an anodised aluminium body

### TECHNICAL INFORMATION

#### Affinity Options

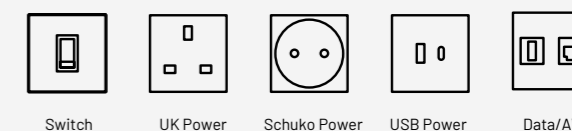

### DIMENSIONS

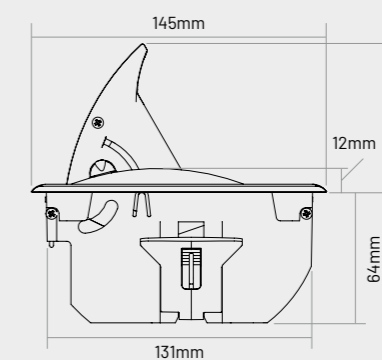

**Customisable variants available.**

Please speak to your Account Manager for more information.

## Conti

Conti is a versatile desk power system that allows compliance with BS 7671 Requirements for electrical installations or BS 6396 Electrical systems in furniture - specification. Configurable to suit your project's bespoke requirements, Conti has a wide range of power, protection, data and AV options.

### OVERVIEW

- Allows compliance with BS 7671 or BS 6396
- Can be fitted with a wide variety of circuit protective devices
- A comprehensive range of power, data and AV outputs & inputs available
- Manufactured to BS 5733 General requirements for electrical accessories
- Available with 32A Neutrik socket to allow units to be fitted after floor tiles are laid

### DIMENSIONS

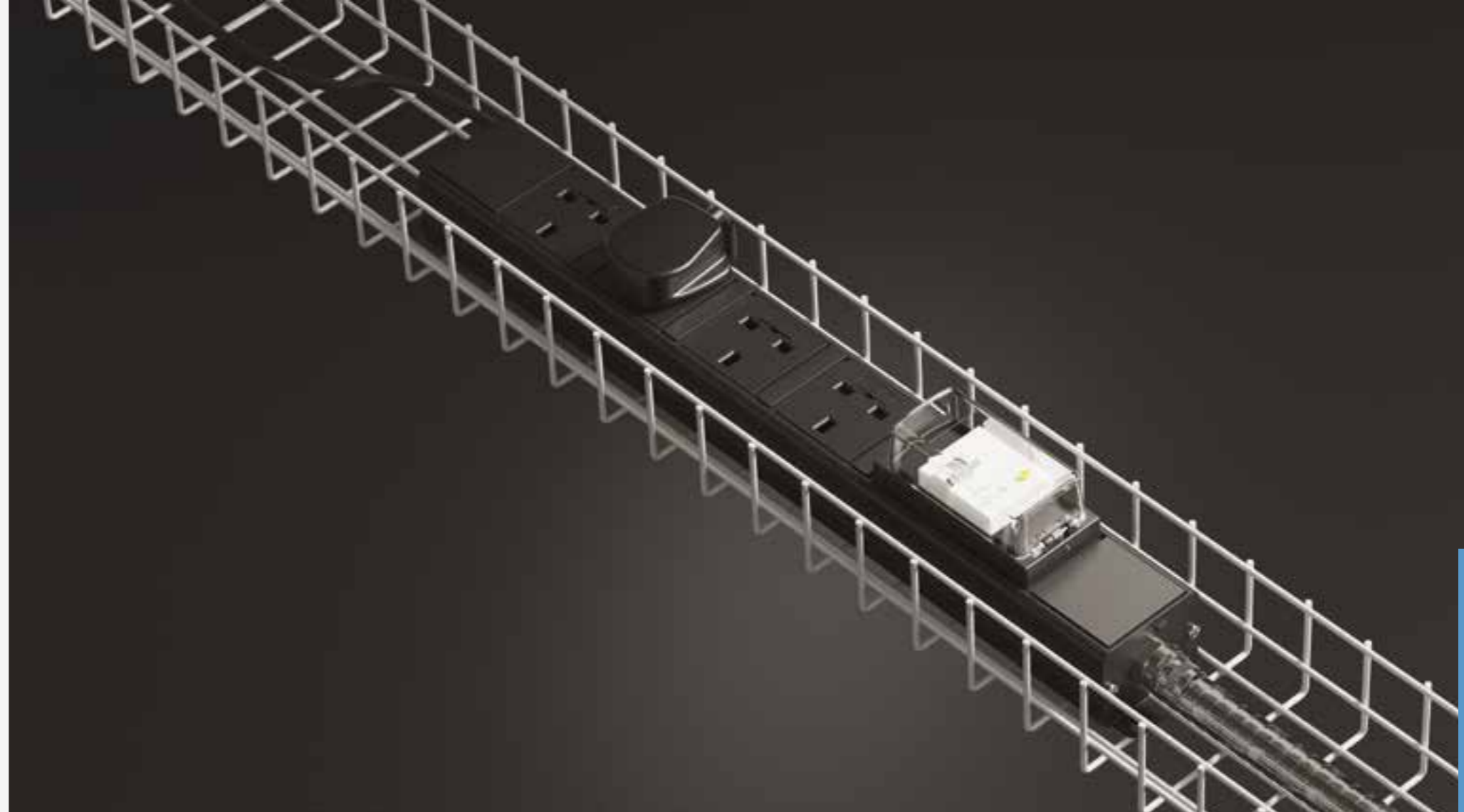
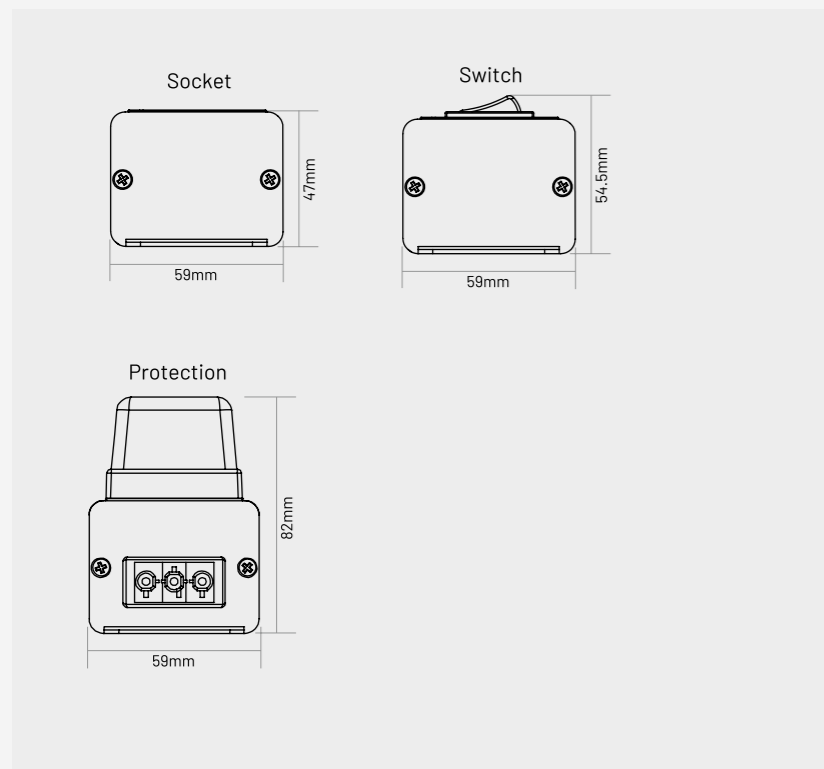

# Conti - common specification options

Conti modules can be specified in a variety of ways, depending on the individual requirements of each project. Some commonly specified options are shown below.

**POWER INPUTS**

Betrak Standard Earth Tap-off    Betrak Clean Earth Tap-off    Neutrik Socket    Wieland GST Socket (3 Pole)    Wieland GST Socket (4 Pole)    Terminal Block (End Cap Not Shown for Clarity)

**CIRCUIT PROTECTION**

MCB    RCBO    RCD    13A Fuse

**SWITCHES**

Single Pole Neon    Double Pole Neon    Neon Indicator

**POWER SOCKETS**    Select from our comprehensive range of UK and international power sockets. UK sockets are available in different orientations and either individually fused (3.15A or 5A) or unfused.

UK Unfused    UK Fused    UK Unfused 45    UK Fused 45    5A Twin Type A USB    18W Type A/C USB

Schuko/German (Shuttered)    French/Belgian    Italian

**WIELAND GST POWER CONNECTORS**    16A rated 3 pole or 4 pole Wieland GST power connectors can be used in conjunction with UK or international power sockets to provide a dedicated power output that can be utilised to feed further workstations and/or on desk power modules.

Wieland End Cap (3 Pole)    Wieland End Cap (4 Pole)    Wieland GST Socket (3 Pole)    Wieland GST Socket (4 Pole)

**AV AND DATA SOCKETS**    Select from our comprehensive range AV and data sockets, that can be supplied pre-wired if required. Contact us to discuss your requirements.

RJ45 (Cat 6/6a)    RJ11    Data Cut-out    USB    HDMI    VGA    3.5mm Audio    Phono    S Video

**2 Way Conti Data Module.**  
2x 6C Cut Outs Facing East West.  
20mm Entry Hole.



**4 Way Conti Data Module.**  
4x 6C Cut Outs Facing East West.  
20mm Entry Hole.



**6 Way Conti Data Module.**  
6x 6C Cut Outs Facing East West.  
20mm Entry Hole.



## Conti

**Circuit Protection and Switching**  
MCB, RCBO, RCD or 13A fuses are available. Choose from a range of switches.

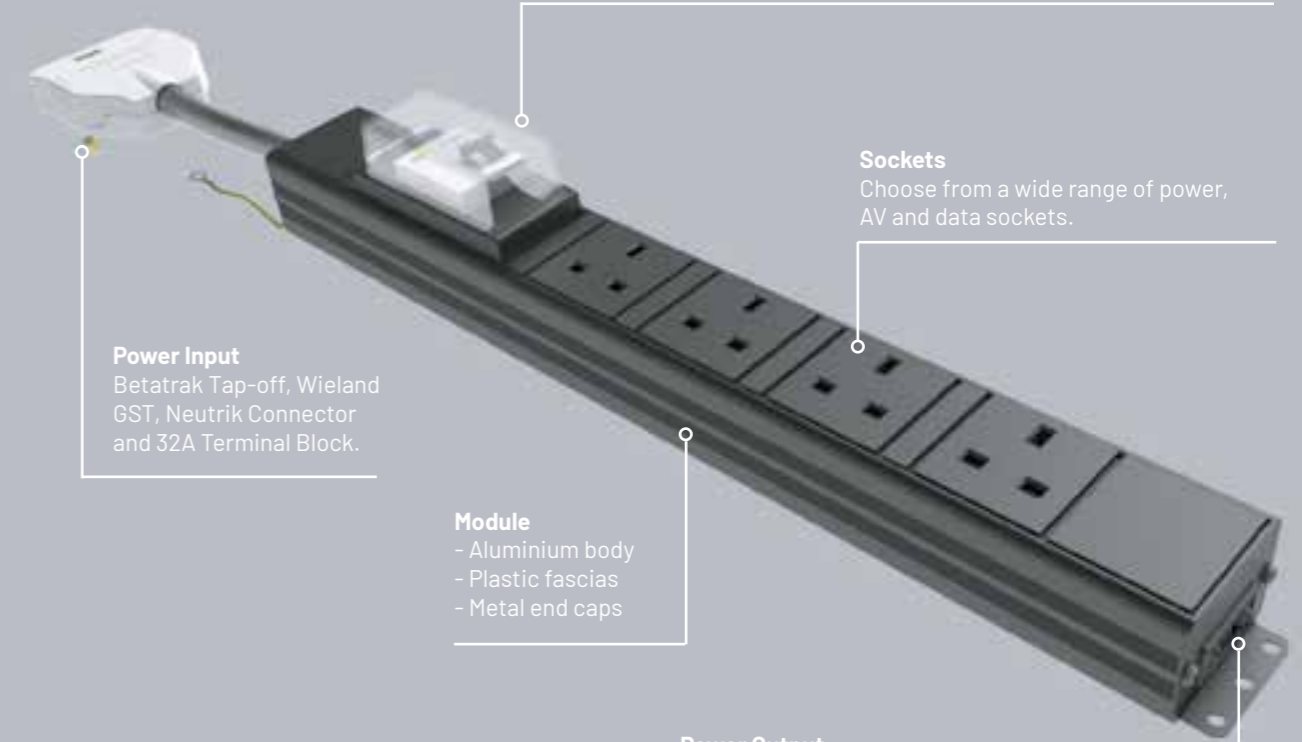

**Power Input**  
Betrak Tap-off, Wieland GST, Neutrik Connector and 32A Terminal Block.

**Sockets**  
Choose from a wide range of power, AV and data sockets.

**Module**  
- Aluminium body  
- Plastic fascias  
- Metal end caps

**Power Output**  
A Wieland GST socket end cap can supply power to another workstation module. Conti can be used as a workstation power distribution system using multiple Wieland GST sockets.

## Elite+

Elite+ is a fixed format under desk power system that allows compliance with BS 6396 Electrical systems in office furniture and educational furniture.

### OVERVIEW

- Allows compliance with BS 6396
- Separate RCD circuit protection module available
- A comprehensive range of 2, 3, 4 and 6 gang power modules
- Manufactured to BS 5733 General requirements for electrical accessories
- Utilises standard 3 pole Wieland GST connections
- Plastic fire retardant body
- Supplied pre-fitted with earth lead

### DIMENSIONS

#### 16A RCD Circuit Protection Module

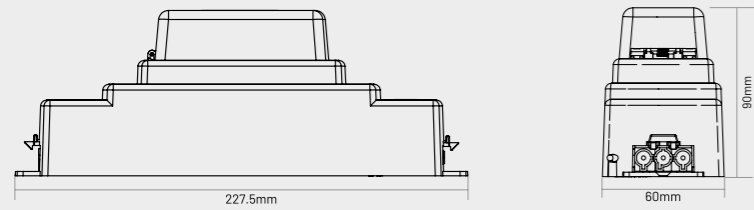

#### 2 Gang 3.15A Individually Fused Sockets

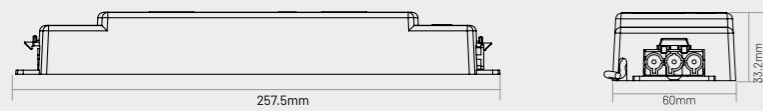

#### 3 Gang 3.15A Individually Fused Sockets

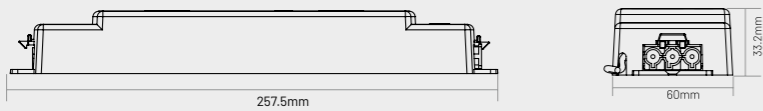

#### 4 Gang 3.15A Individually Fused Sockets

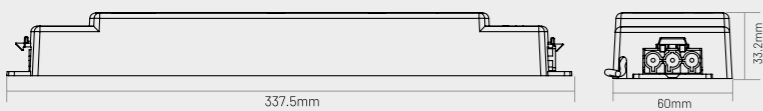

#### 4 Gang Switched 3.15A Individually Fused Sockets

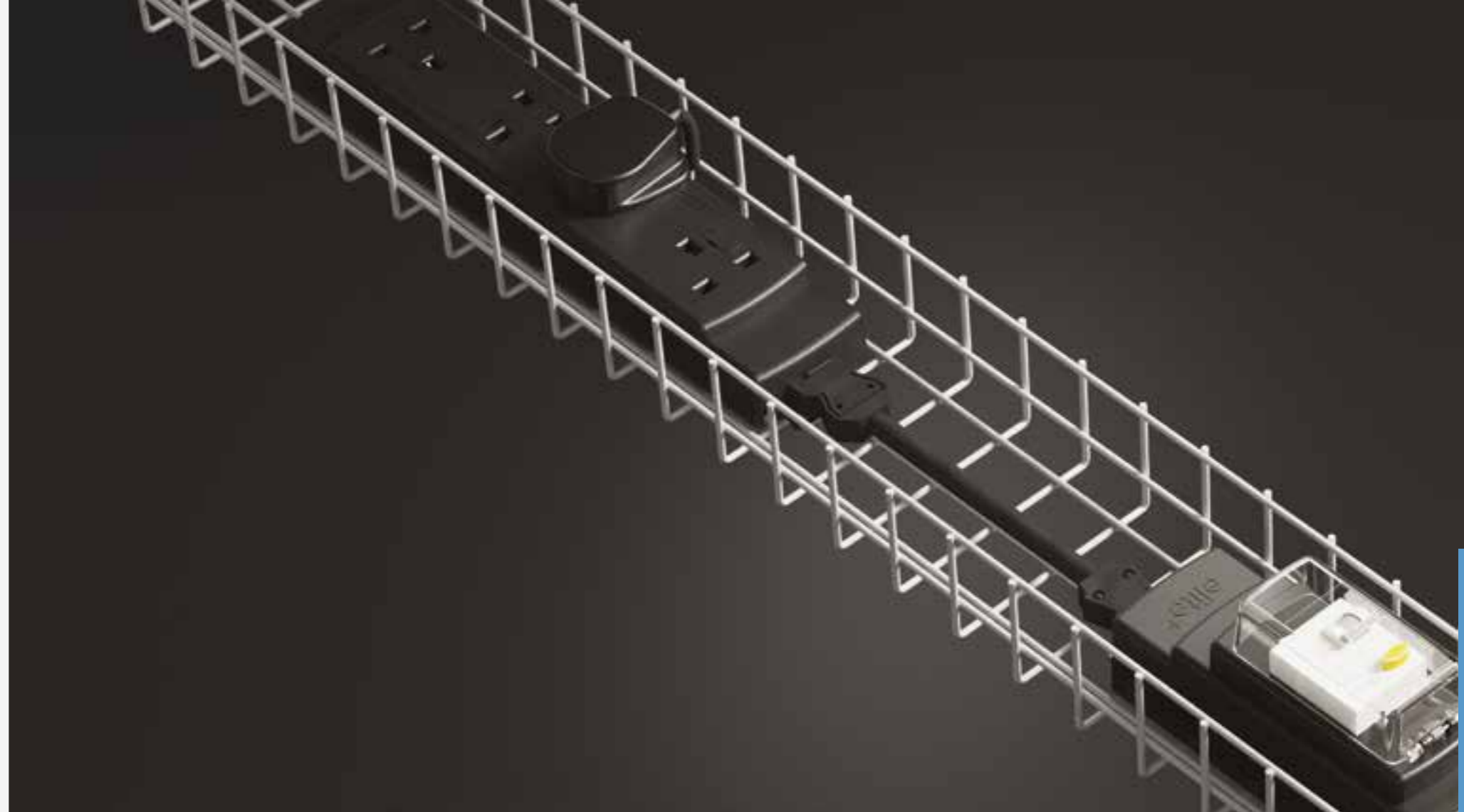
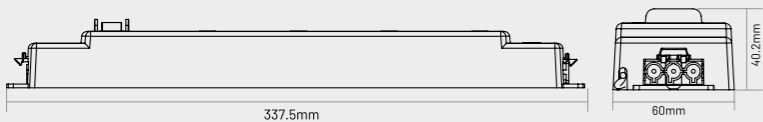

## Elite+ specification guide

**STEP 1**

Begin by choosing a starter mains cable



1.0m    1.5m    2.0m    3.0m    4.0m    5.0m    6.0m

**STEP 2**

If a circuit protection device is required select a 16A 30mA RCD module

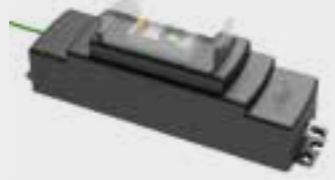

**STEP 3**

Choose a combination of the following socket modules depending on the total number of sockets required:



2 gang 3.15A or 5A    3 gang 3.15A or 5A    4 gang 3.15A or 5A    4 gang switched 3.15A or 5A    6 gang switched 3.15A or 5A

**STEP 4**

If modules are to be connected to each other, chose an interconnect cable



0.3m    0.5m    1.0m    1.5m    2.0m    3.0m    4.0m

Choose from our ranges of on desk workstation modules.

Return to **STEP 3** to choose sockets for the additional workstation(s).

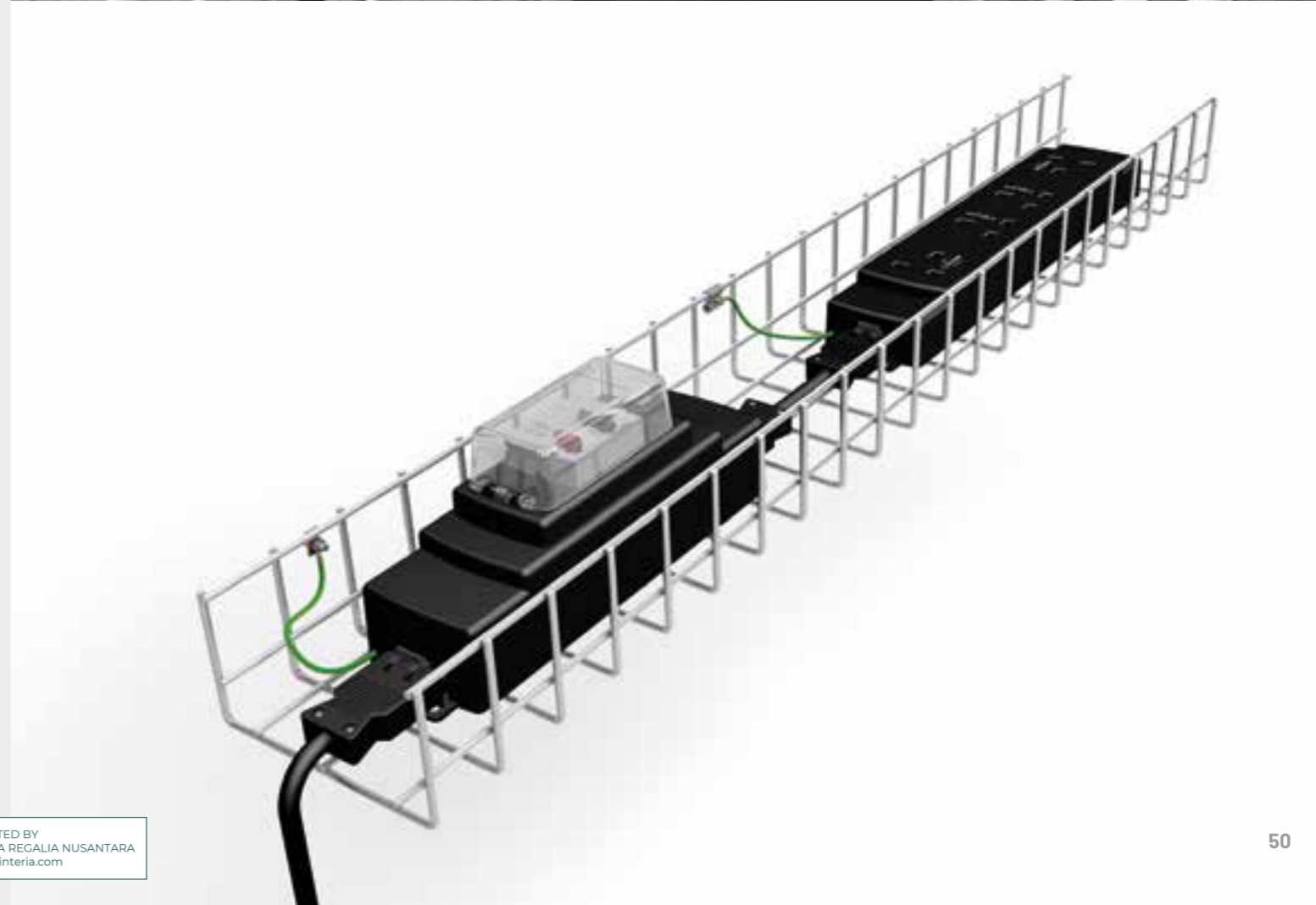

## Monitor Arms

Our range of monitors have been design to enable users to work safely and productively. Choose from our dynamic or pole monitor arms for single or dual screen workstations that will compliment any working environment.

MONITOR ARMS



MIRO



REACH HD

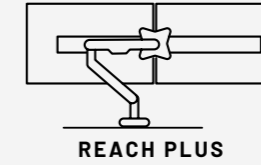

REACH PLUS

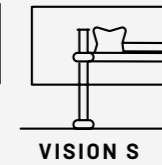

VISION S

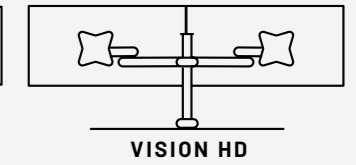

VISION HD

SIT STAND

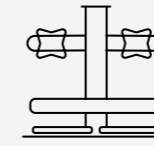

ACTIVE





## Miro

Miro is a dynamic monitor arm that allows enables vertical movement of the monitor. Synchronised movement of the lower and upper arm allows the monitor to be raised or lowered simply and easily without any need for sideways or forward motion. Available in black or white, with integral cable management and a top fixing c-clamp.

### OVERVIEW

- **Finger touch movement**
- **External cable management**
- **Top fixing c-clamp**
- **Support monitors weighing between 2kgs and 9kgs**
- **15 year warranty**
- **Available in black or white**

### DIMENSIONS

Top Fixing C-clamp

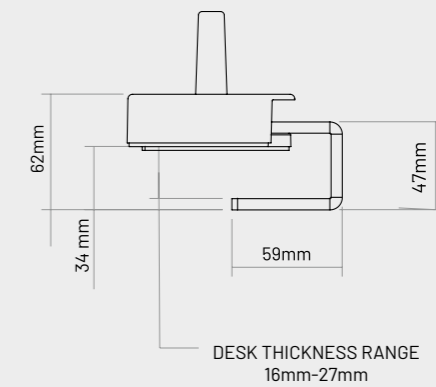

## Reach HD

Reach has all the key features required for a modern office. Supplied with top fixing c-clamp as standard and awarded an Ergonomics Excellence Award for computer accessories from FIRA.

### OVERVIEW

- Supplied with top fixing c-clamp
- Integral cable management
- Quick release VESA (Supports VESA 75mm & 100mm)
- Reach HD arm supports monitor weights between 3kg - 8kg
- 180 Degree lockout option as standard
- Awarded Ergonomics Excellence by FIRA
- 10 year warranty
- Available in black, white and silver

If mounting a curved screen, the maximum weight of the monitor may need to be reduced. If in doubt, a product mock-up using your chosen curved screen is highly recommended

### DIMENSIONS

Top Fixing C-clamp

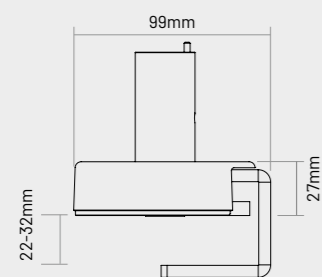

Split C-clamp

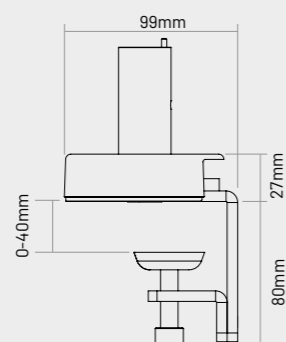



## Reach Plus

Reach Plus is an elegant dual monitor arm that has all the key features required for a modern workspace. Supplied with top fixing C-clamp as standard.

### OVERVIEW

- Reach Plus supports combined monitor weights between 6kg - 15kg
- Supplied with top fixing c-clamp
- Integral cable management
- Quick release VESA (Supports VESA 75mm & 100mm)
- Reach Plus is available as both a single and dual screen option
- 180 Degree lockout option as standard
- 5 year warranty
- Available in black, white and silver

If mounting a curved screen, the maximum weight of the monitor may need to be reduced. If in doubt, a product mock-up using your chosen curved screen is highly recommended

### DIMENSIONS

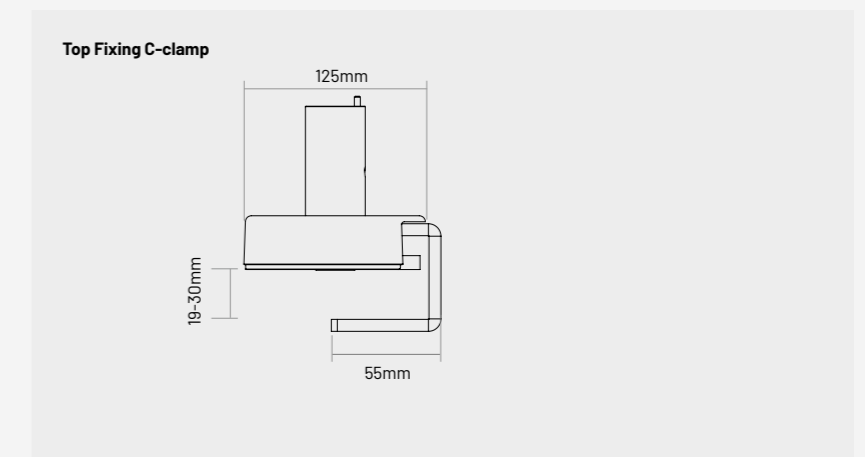

## Vision S

Vision S is a compact monitor arm, designed to support monitors weighing up to 6kgs. Available as a single and dual screen pole arm, Vision S is supplied with standard desk c-clamp but can easily be adapted to fit an 80mm grommet hole or bolted through the desk surface. Vision S also includes external cable management and a quick released VESA for quick and easy installation.

### OVERVIEW

- Supplied with standard fixing c-clamp
- External cable management
- Quick release VESA (Supports VESA 75mm & 100mm)
- Single and dual screen options
- Each arm can support monitor up to 6kg
- Available in black, white and silver

### DIMENSIONS

C-clamp

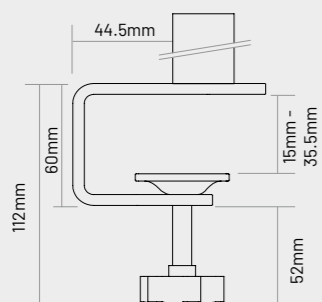



## Vision HD

Vision HD is a compact monitor arm, designed to support monitors weighing up to 10kgs. Available as a single and dual screen pole arm, Vision HD is supplied with standard desk c-clamp but can easily be adapted to fit an 80mm grommet hole or bolted through the desk surface. Vision HD also includes external cable management and a quick released VESA for quick and easy installation.

### OVERVIEW

- **Supplied with standard fixing c-clamp**
- **External cable management**
- **Quick release VESA (Supports VESA 75mm & 100mm)**
- **Single and dual screen options**
- **Each arm can support monitor up to 8kg**
- **Available in black, white and silver**

### DIMENSIONS

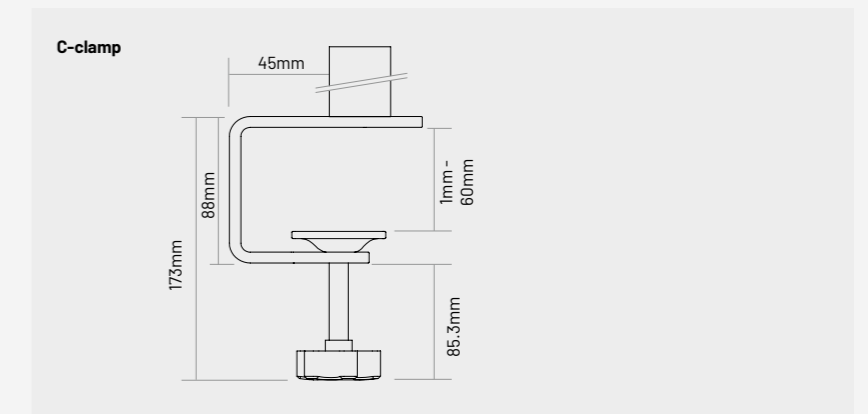



## Active Sit Stand

Active instantly converts any desk into a sit to stand workstation. At the touch of a button, the user can go from sitting to standing, promoting a healthier working environment.

### OVERVIEW

- Quick and easy to install
- Single and dual screen options
- Supports monitors up to 14kgs
- Power assisted height adjustment
- Available in white

### DIMENSIONS

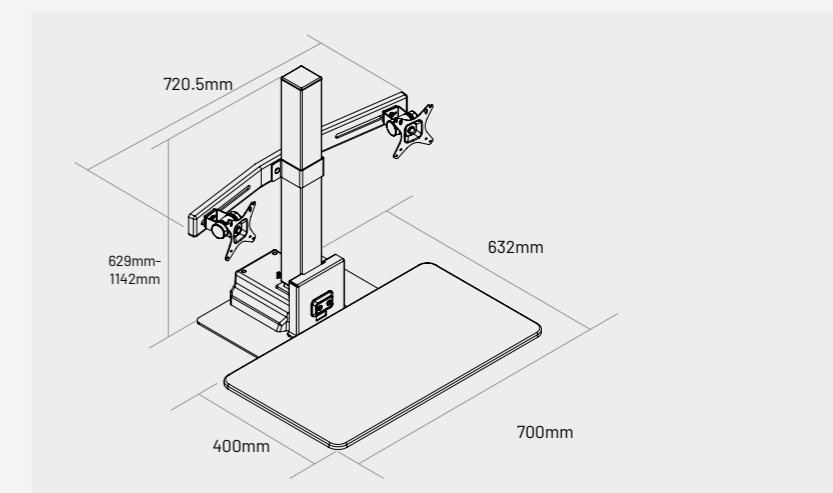

## Miro - Design Innovation

*"CMD approached me about a new arm and I was really excited. We both wanted to do something different, something special, something really innovative that moved the market forward."*

- Andrew Wills  
**Designer of Miro**

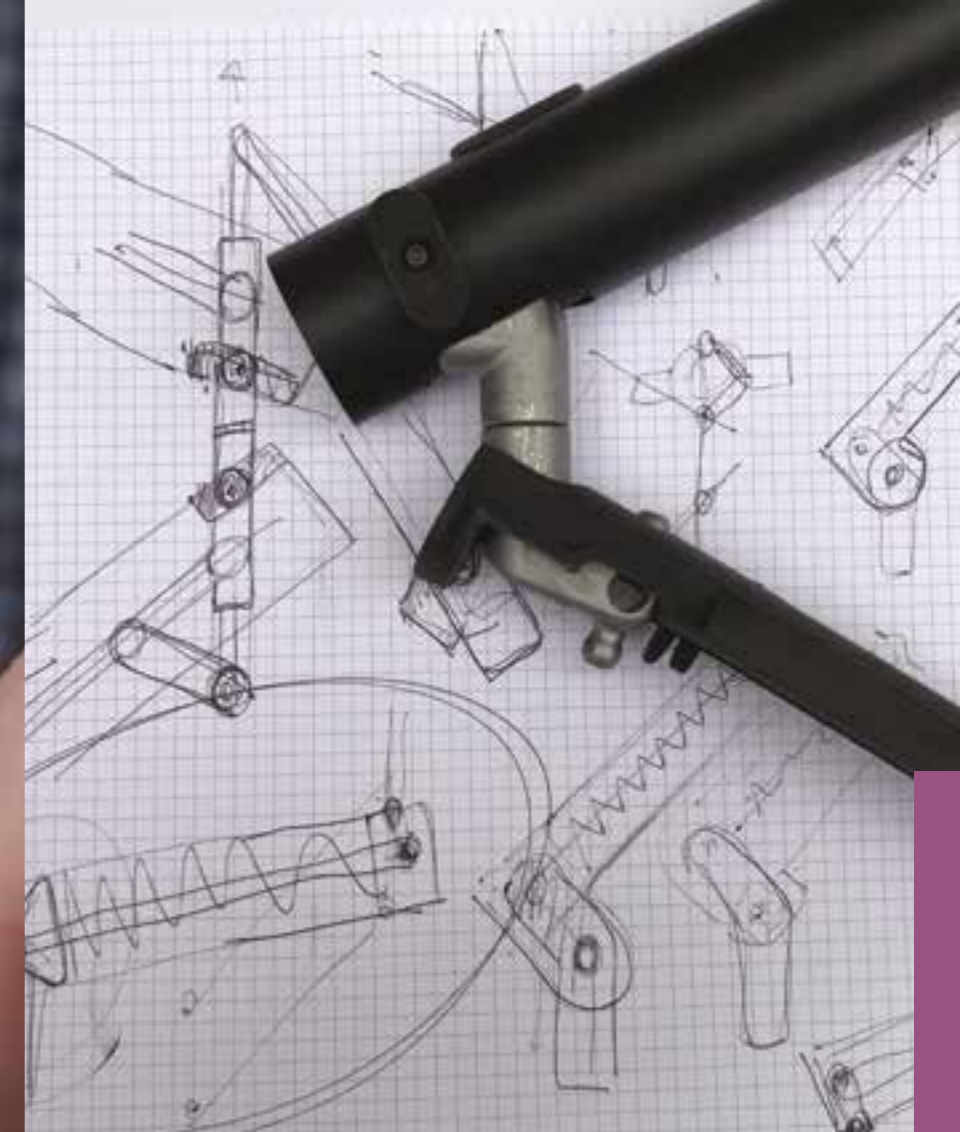
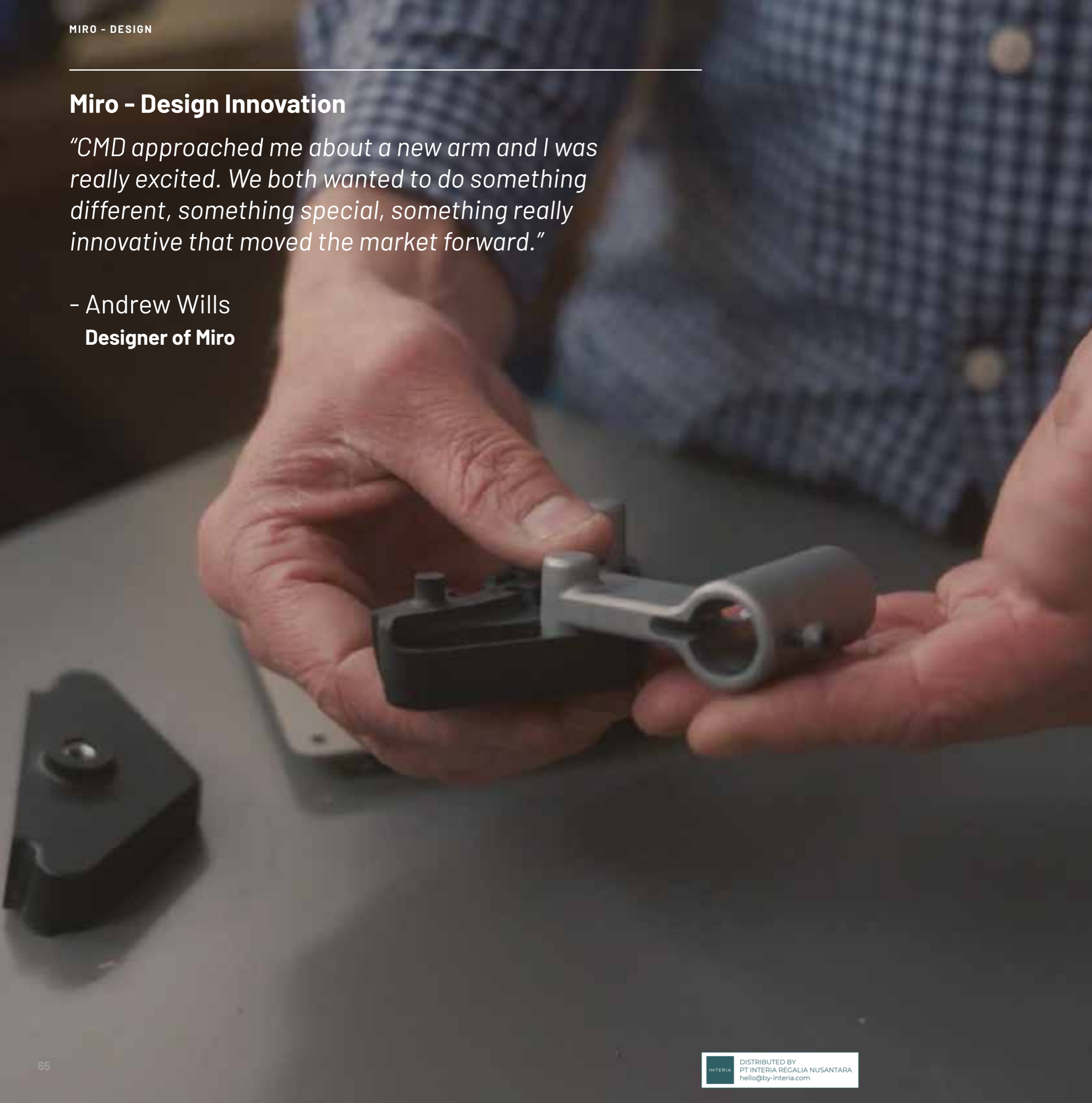

## Anatomy of a monitor arm and why they are essential

A monitor arm will allow you to set your monitor to the most comfortable position, allowing you to adjust the height, depth, and in most cases, the angle of your monitor.

Whether sitting or standing, it will improve your ergonomic posture and help reduce eye strain, back and neck pain.

### PORTRAIT LANDSCAPE ROTATION

- Effortless fingertip adjustment

### DUAL AND WIDE SCREEN OPTIONS

- Dual monitors have been proven to increase productivity by up to 42 percent\*

### CABLE MANAGEMENT

- Cable management keeps your desk neat and tidy

### DESK FIXINGS

- A range of desk fixing options are available depending on your installation requirements

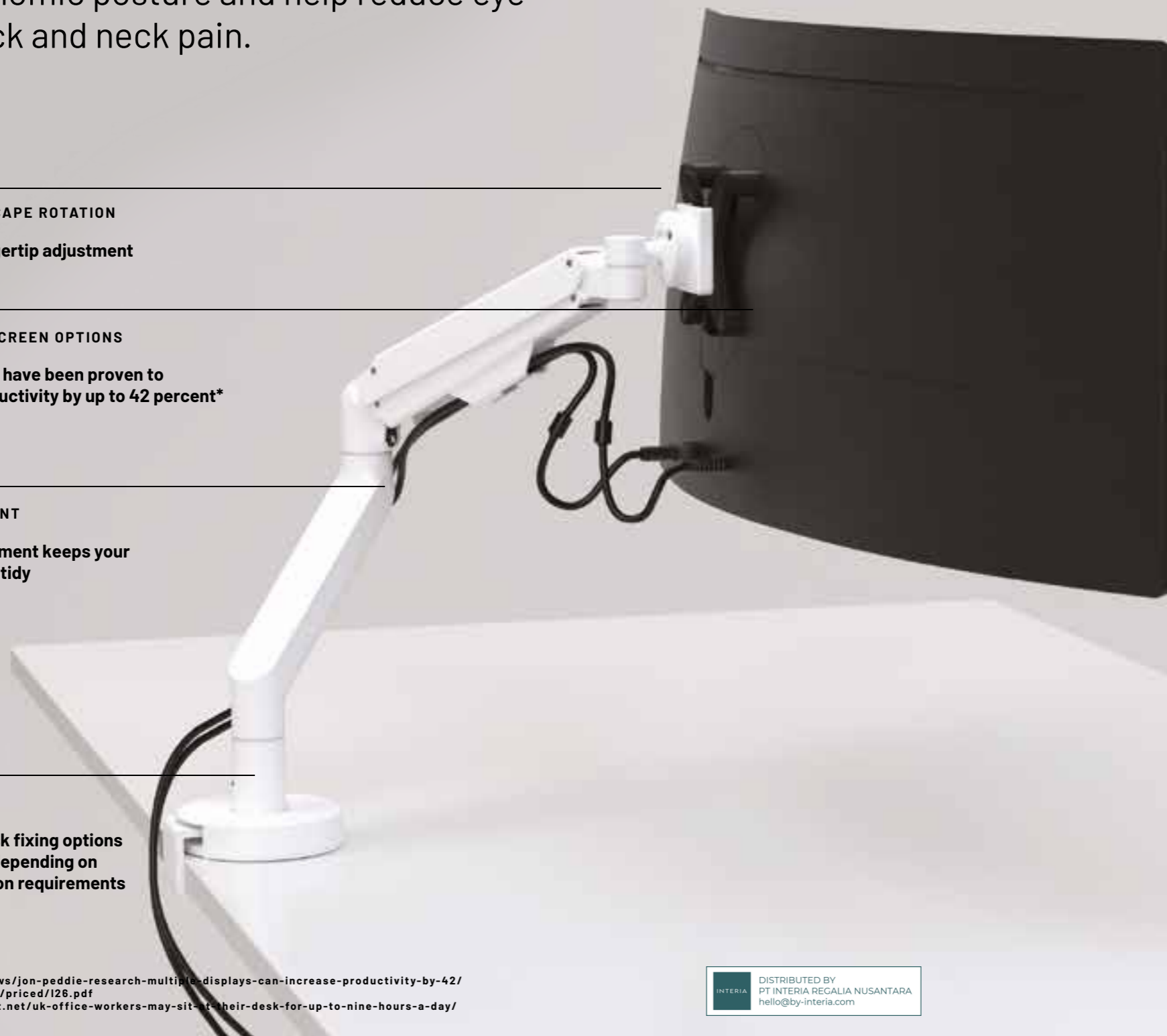

## ERGONOMIC QUICK SET-UP GUIDE

When you view your monitor, there are two important elements that affect ergonomics;

- seated eye height / level
- distance from the monitor

Optimum monitor viewing for most users is slightly below eye level. In terms of viewing distance, having the monitor at arms reach is a good starting point. Your workplace environment and age are 2 factors which can dictate whether this needs to be adjusted.

## ERGONOMIC POSITIONING

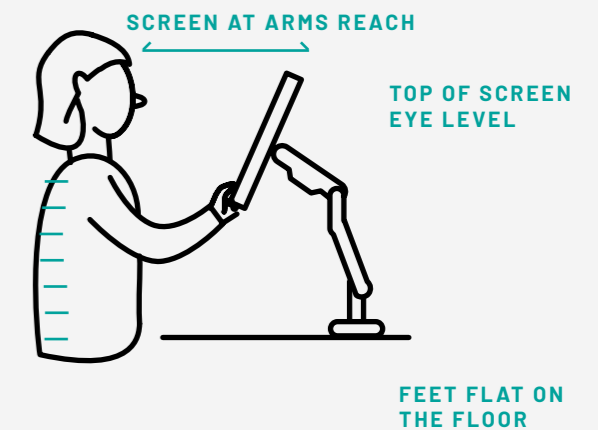

## KEY STATS

**60% OFFICE WORKERS WILL ENCOUNTER BACK OR NECK PAIN\*\***

**7.3 MILLION OF DAYS WILL BE LOST TO MSD WORKPLACE DISORDERS\*\***

**81% OF UK OFFICE WORKERS SPEND BETWEEN 4 & 9 HOURS EACH DAY SITTING AT THEIR DESK\*\*\***

## Workstation Essentials

Our range of workstation essentials help to create healthier workplaces that improve performance and bring greater productivity. They deliver a more streamlined and aesthetically appealing space.

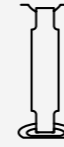

TIDY



SPIRAL

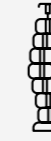

CABLEWAY



FUSION

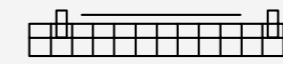

PREMIUM



GROMMETS





## Tidy

A fabric cable management spine that fits a wide range of desk systems. Tidy is extremely easy to install and includes internal segregation for power and data cables. The hook and eye fixing straps allow for adjustment to fit a range of desk heights.

### OVERVIEW

- **Adjustable height from 690mm to 790mm to cater for different desk heights**
- **Quick and easy to install**
- **Cables can be installed by opening the zip, placing inside the spine, and re-fastening the zip**
- **Internal segregation available for power and data cables**
- **Available in black, white or grey**

### DIMENSIONS

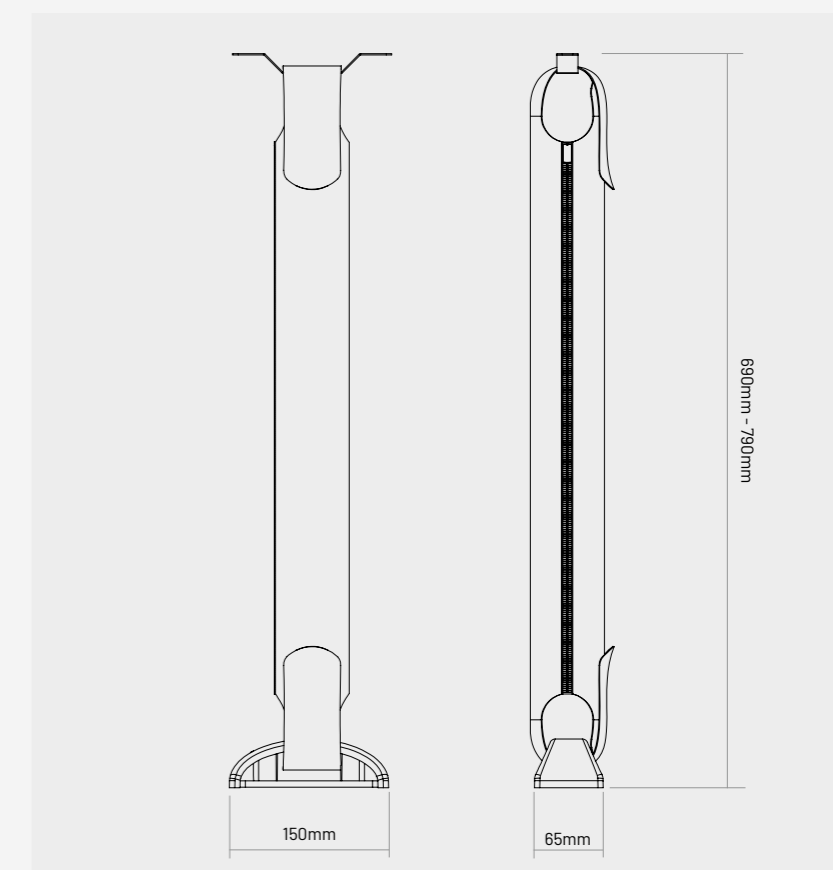

## Spiral

Spiral cable spine is a desk to floor cable management solution that offers exceptionally quick and easy installation, plus a large cable carrying capacity.

### OVERVIEW

- Adjustable height from 165mm to 1300mm to cater for different desk heights
- Quick and easy install
- Available in black, white or grey

### DIMENSIONS

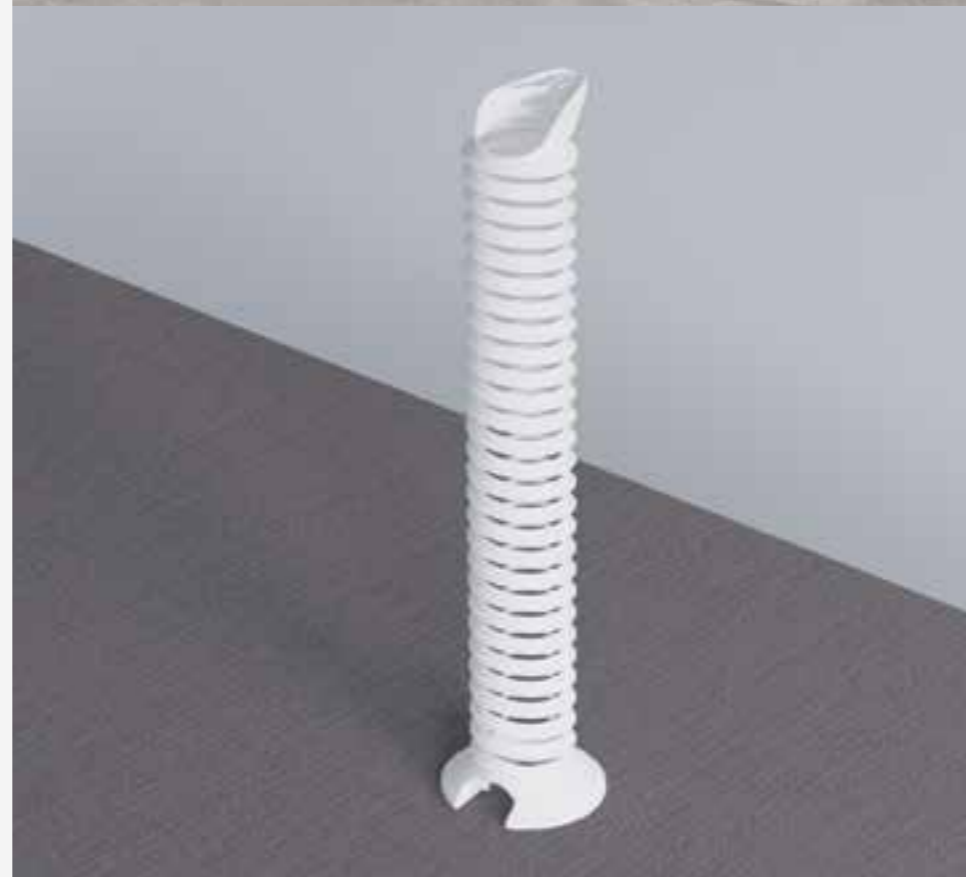
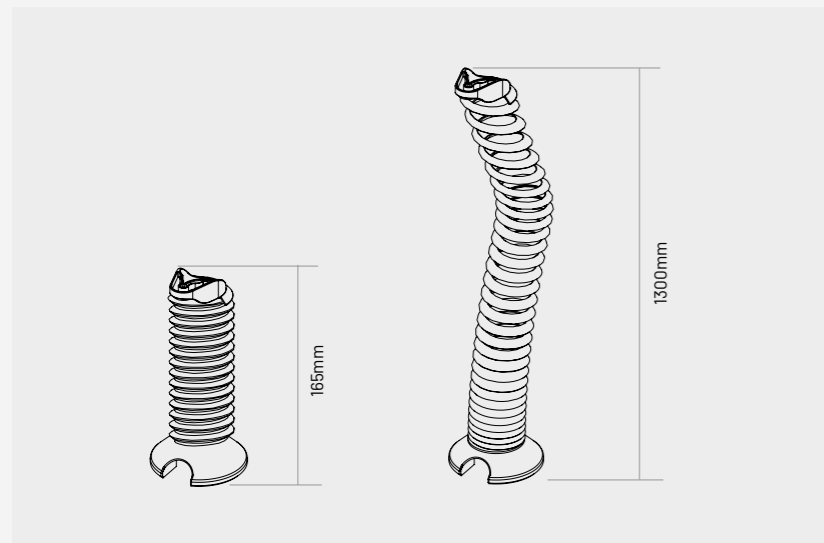



## Cableway

An attractive and practical method of cable containment. The Cableway routes cables from floor to desk and provides mechanical protection and strain relief.

### OVERVIEW

- **Two compartments to allow for power and data cable segregation**
- **The Vertical Cableway screws to underside of the desk using a top bracket (fixing kit included)**
- **Weighted base for free standing floor to desk section**
- **Internal channel allows 3 pole connectors (Wieland) through**
- **Allows conduit up to 25mm diameter to be swiped in**
- **Segments are detachable for easy re-configuration**

### DIMENSIONS

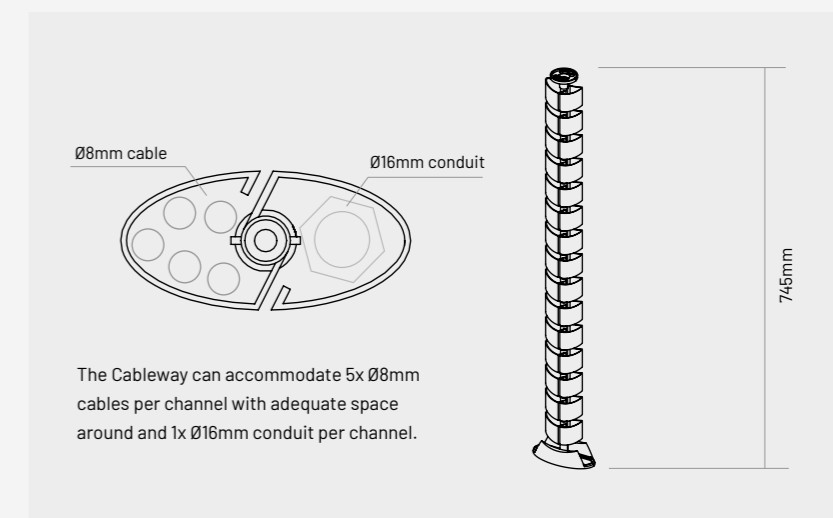

## Fusion

Fusion is a cable containment basket which clips to the underside of the desk to allow power and data cables to be installed neatly under the desk surface. Fusion is available in five different lengths ranging from 800mm to 1600mm.

### OVERVIEW

- 5 standard lengths, 800mm, 1,000mm, 1,200mm, 1,400mm, 1600mm.
- Sloped on front facing side for easy access
- Maximum weight depends on length
- Includes an earthing point
- Fixing brackets supplied
- Available in silver (RAL 7040)

### DIMENSIONS

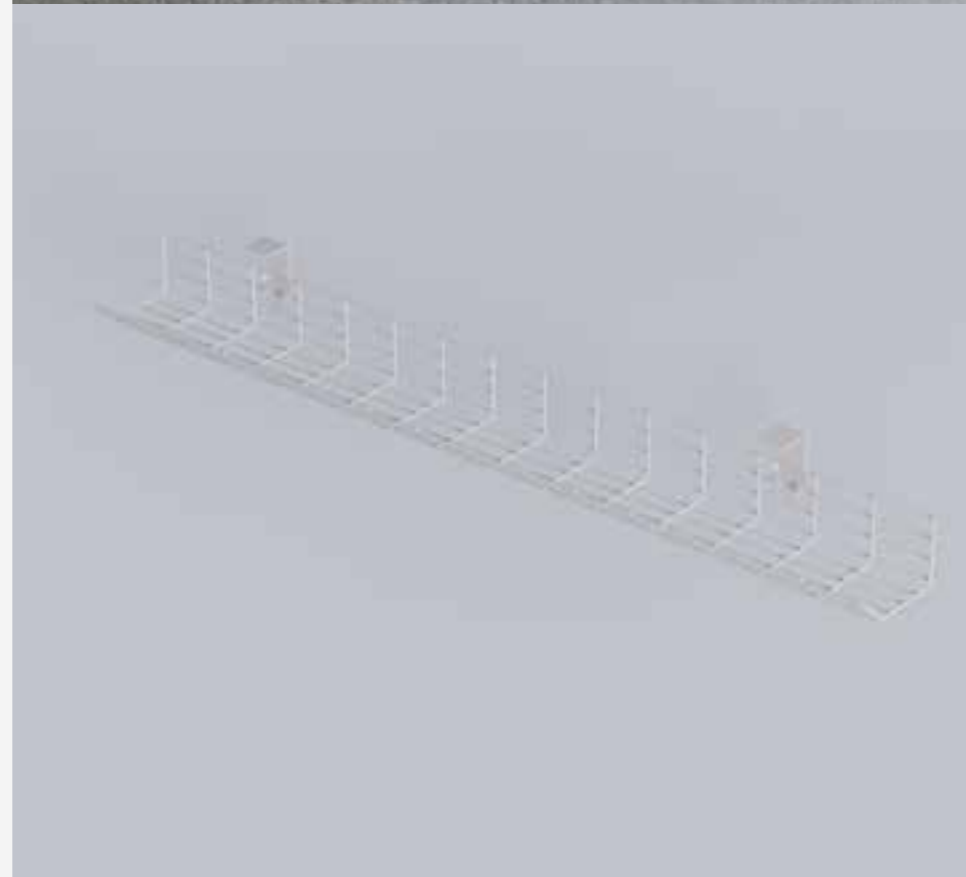
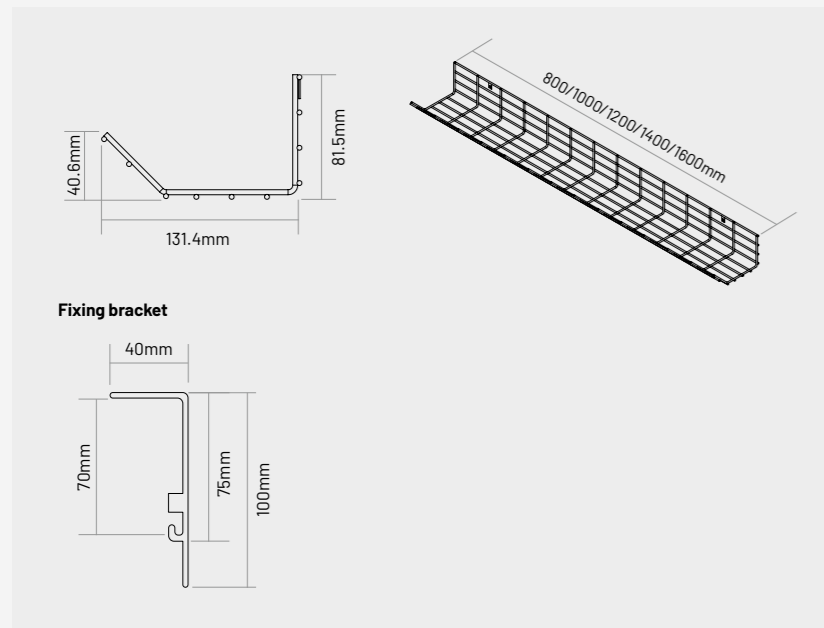

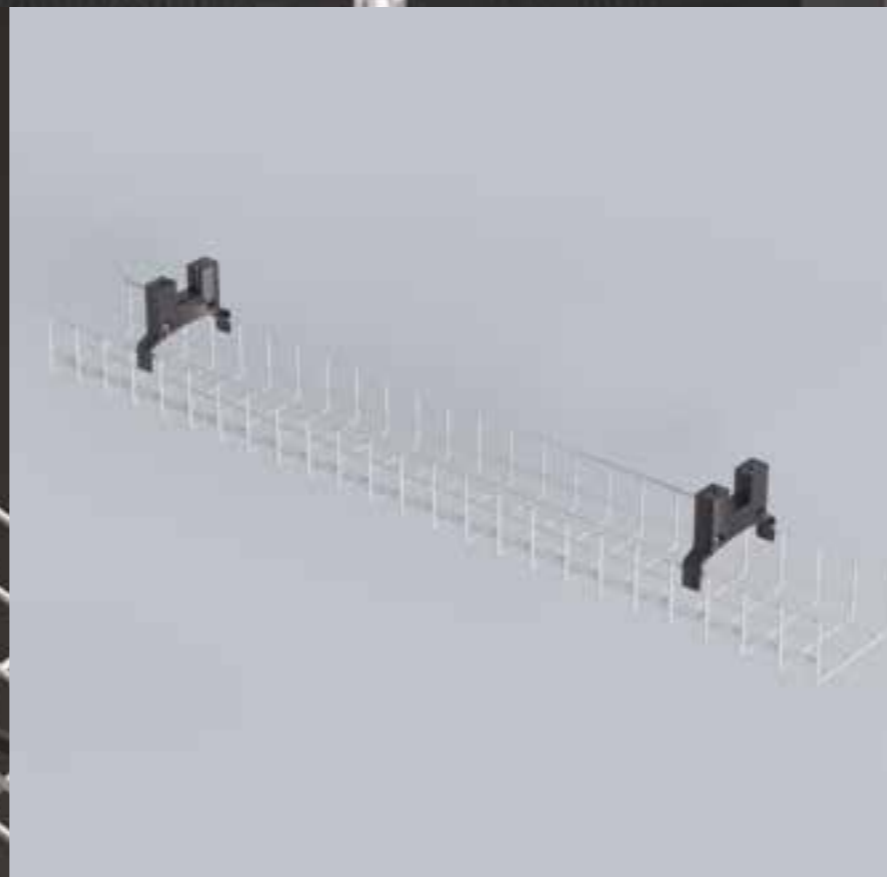
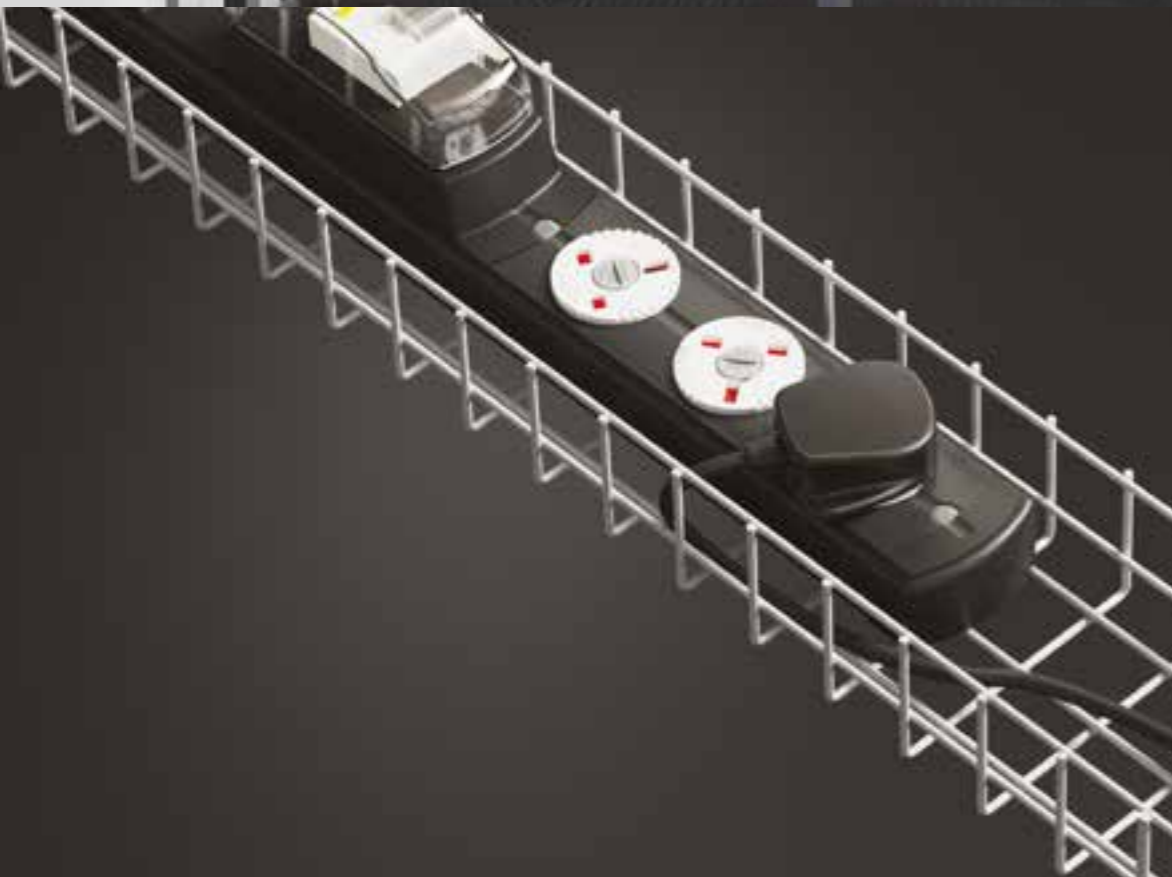

## Premium

Premium is a cable containment basket which clips to the underside of the desk to allow power and data cables to be installed neatly under the desk surface. Premium is available in five different lengths ranging from 1000mm to 1800mm.

### OVERVIEW

- 5 Standard lengths - 1,000mm, 1,200mm, 1,400mm, 1,600mm, 1,800mm
- Maximum weight depends on length
- Includes an earthing point
- Fixing brackets supplied
- Available in silver (RAL 7040) or white (RAL 9010)

### DIMENSIONS

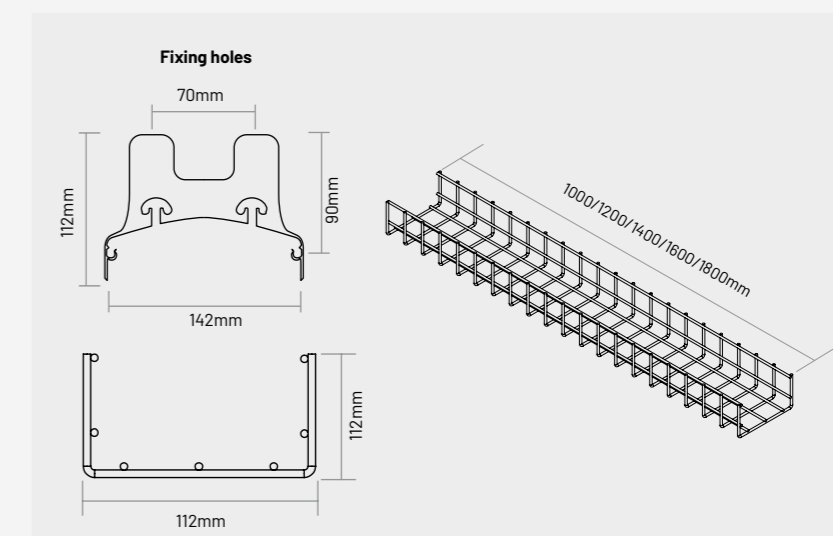

## Desk Grommets

Metal desk grommets are made from a high quality cast aluminium and are available in polished, brush nickel and matt chrome finish. Plastic desk grommets are made from a high quality plastic and are available in grey, black and white.

### OVERVIEW

- Easily retro fitted into an 80mm diameter hole
- Minimum work surface thickness is 12mm
- Available in metal or plastic
- Strong and durable for long term cable management
- Designed to aid health and safety by reducing the trip when used in conjunction with our range of cable management solutions

### DIMENSIONS

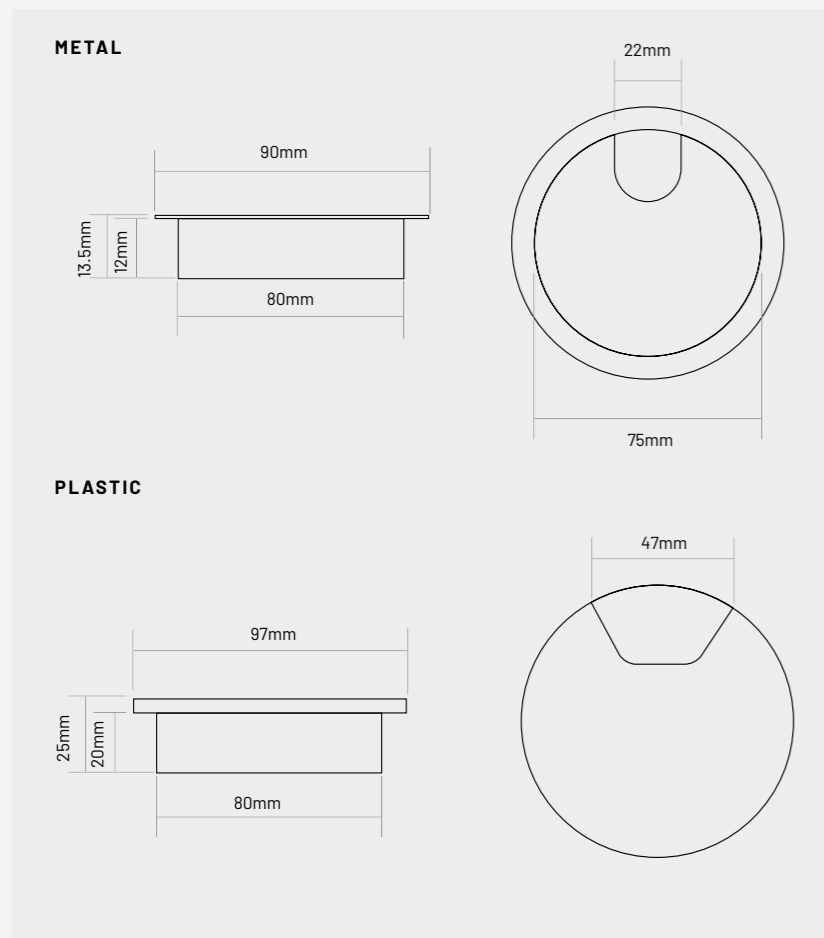

## Power Distribution

Our products have been designed to be easy to install over traditional cabling systems with no requirement for cable trays and complicated terminations. We also have a wide selection of accessories, tap-offs and grommets to suit every underfloor power requirement.

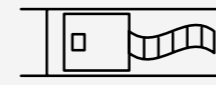

BETATRAK

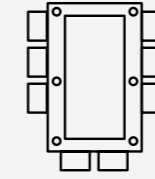

POWER HUB

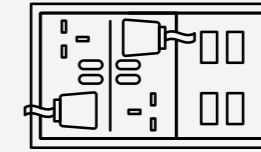

FLOOR BOXES

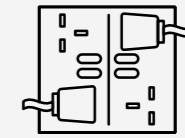

SLAB BOXES

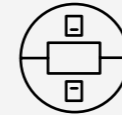

CABLE HIVES



CABLE GROMMETS

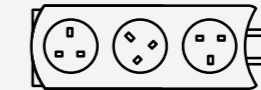

ROTASOC

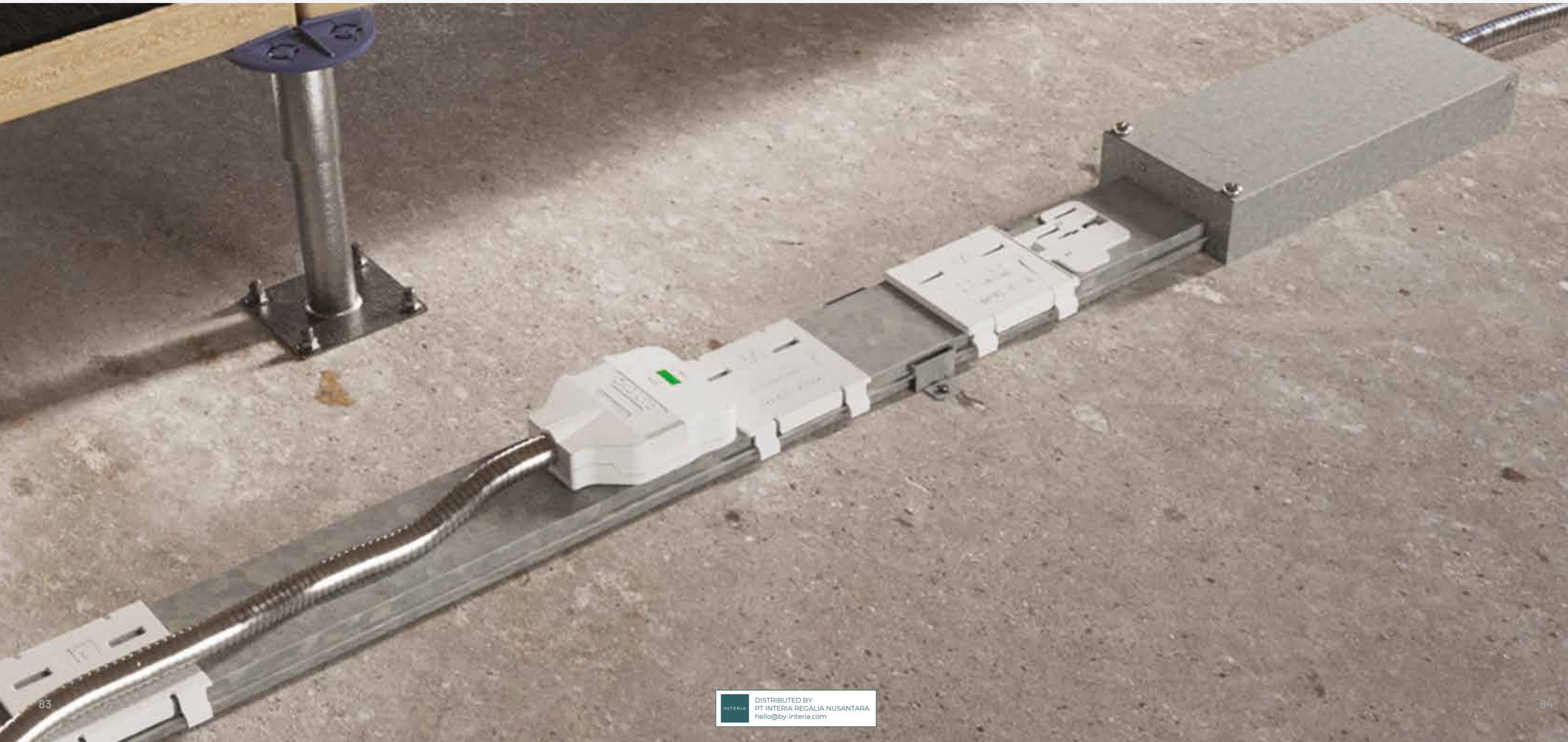

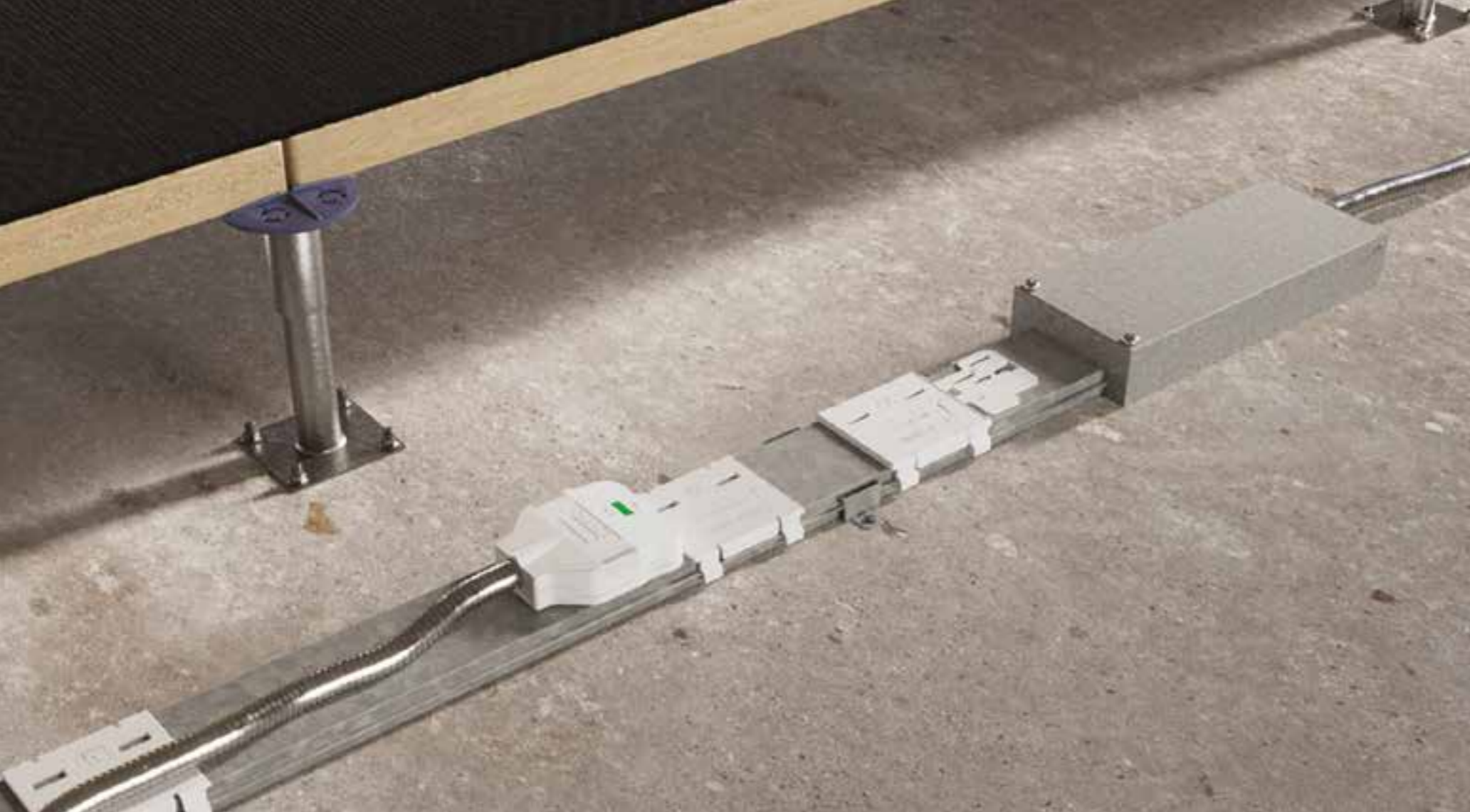

## Betrak®

Betrak is our powertrack, power distribution system and has been designed and manufactured in accordance with BS EN 61534-22 Powertrack systems. A comprehensive range of solutions independently certified to BS EN 61534-22.

The 63A Betrak system caters for Standard Earth, Clean Earth (C/E) low noise, Auxiliary Earth, Dual Circuit or 3-Phase applications. Betrak is installed into raised access floors and there is an option for installation into ceiling areas. Betrak comes in lengths of 1.2m, 1.8m, 2.4m or 3.6m with tap-off positions provided at 300mm as standard and supplied with integral fixing brackets and sliding dust covers.

### OVERVIEW

- Each length of Betrak is fitted with fast-fit connection and fixing brackets
- Feed units are supplied with a stop-end cap
- Sockets are colour and key coded to avoid installation errors and to ensure a secure tap-off connection
- Tap-off outlets are protected by integral sliding dust covers

### FEATURES

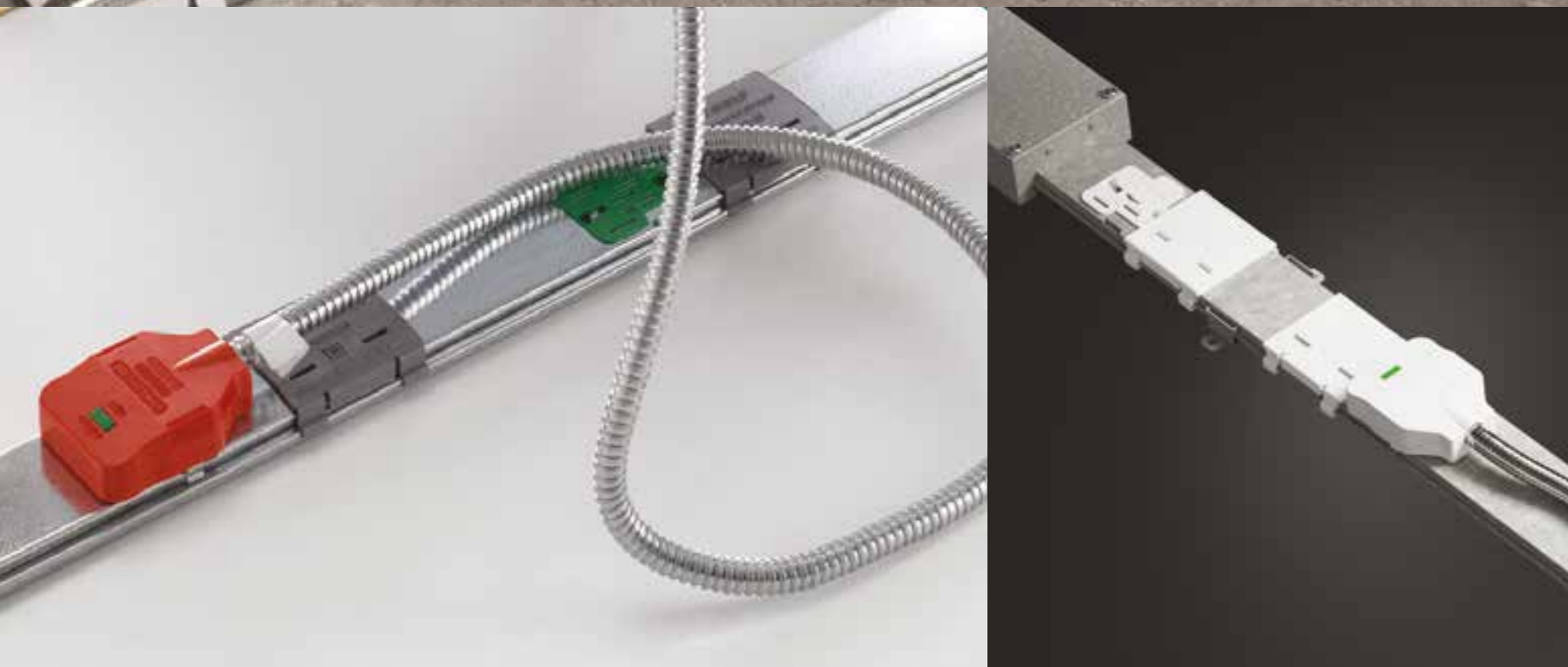

## Betrak Specification Guide

### STEP 1

Begin by choosing your Betrak system type.



### STEP 2

All Betrak circuits start with a feed unit. Select the appropriate feed unit suitable for your system.



### STEP 3

Choose from the Betrak lengths below to complete the overall run length of your system.

- 1.2m
- 1.8m
- 2.4m
- 3.6m



### STEP 4

If runs of Betrak are required to change direction, the floor slab is uneven or there is an obstruction then choose from our range of pre-wired flexible corners or utilise our flexible corner kit option if it would be more convenient to wire the flexible corner on site.



### STEP 5

Choose from our range of pre-wired tap-offs, floor boxes, slab boxes and desk modules to suit your project. Please contact us for assistance in specifying these products.



## Power Hub

Power Hub is our 32A, modular power distribution system designed for buildings where a conventional powertrack system can't be installed due to height restrictions or obstacles in the floor void, or where the slab is uneven. Power Hub is an innovative solution when the environment is preventing runs of powertrack being laid at the same level. Power Hub is low profile at 38mm in height and is made from galvanised steel making it a strong and robust solution.

### OVERVIEW

- Allows compliance with Wiring Regulation 543.7.1.203 BS 7671 for earthing requirements
- 6 way and 4 way Power Hubs available for multiple configurations
- A secure tap-off connection is made using BS EN 61535 connectors housed in a metallic housing
- Supplied with retractable fixing brackets

### DIMENSIONS

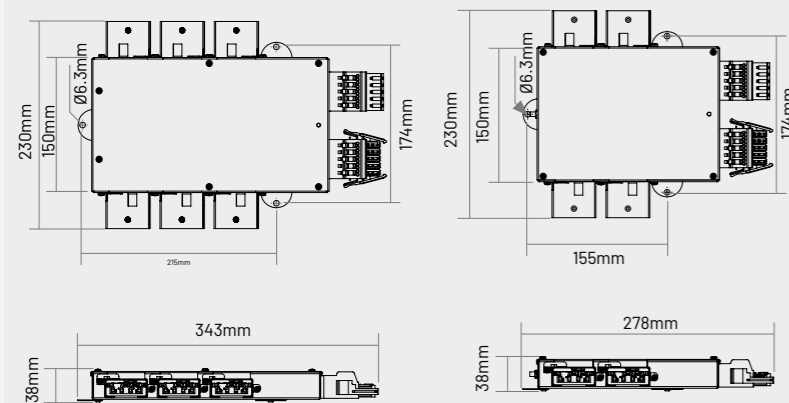

## Floor Boxes

We offer five floor box variants. They are designed for use in commercial environments and provide an efficient fast-fit on site installation and ease of access to power sockets and data.

### OVERVIEW

The floor boxes available are:

- 20 Series Floor Box (Single Box Base)
- 20A Series Floor Box (Separate Box Bases)
- 99 Series Floor Box (Single Box Base)
- 22 Series Stainless Steel Floor Box (Single Box Base)
- 90 Series Stainless Steel Floor Box (Single Box Base)

The 20 and 20A Series fast-fit floor boxes are suitable for raised floor applications. The 99, 22 and 90 Series floor boxes are suitable for raised floor and screed floor applications.

- Multiple options available
- Designed to comply with BS EN 61534 Traffic Load Tests
- All floor boxes for raised floors can be pre-wired with Betatrak Tap-offs for ease of installation
- Low profile floor box surround to reduce the risk of tripping as per BS EN 61534-22 Powertrack systems. Particular requirements for powertrack systems intended for onfloor or underfloor installation, section 9
- 20, 20A and 99 Series floor boxes fit the same floor tile aperture
- Carpet can fit into a 6.5mm recess in versions with a tray lid

### DIMENSIONS

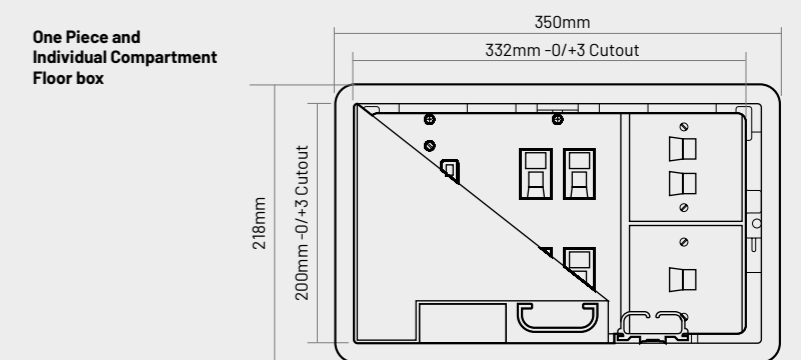

Please note: The dimensions of our 22, 22A and 90 series stainless steel floor boxes differ from those shown above. Please speak to a member of our Power Distribution Sales Team for more information about our range of stainless steel floor boxes.



## Slab Boxes

Our 23 Series Slab Boxes are a power distribution system installed under a commercial office raised floor. There are four slab box variants available, designed to provide a straightforward on site installation. When used in conjunction with our range of floor grommets it is an alternative to a floor box providing ease of access to power sockets and data.

### OVERVIEW

- Multiple options available designed to meet your specification requirements
- Manufactured to comply with BS 5733 General requirements for electrical accessories
- All slab boxes for raised floors can be pre-wired with a Betatrak Tap-off for ease of installation
- Supplied with retractable fixing feet
- Complete with 20/25mm knockouts on two sides
- Multiple compartment slab boxes are supplied with circuit segregation dividers fitted
- Manufactured from 0.9mm galvanised steel
- One and three compartment slab boxes use 3 Compartment size accessory plates
- Two and four compartment slab boxes use 4 Compartment size accessory plates

### DIMENSIONS

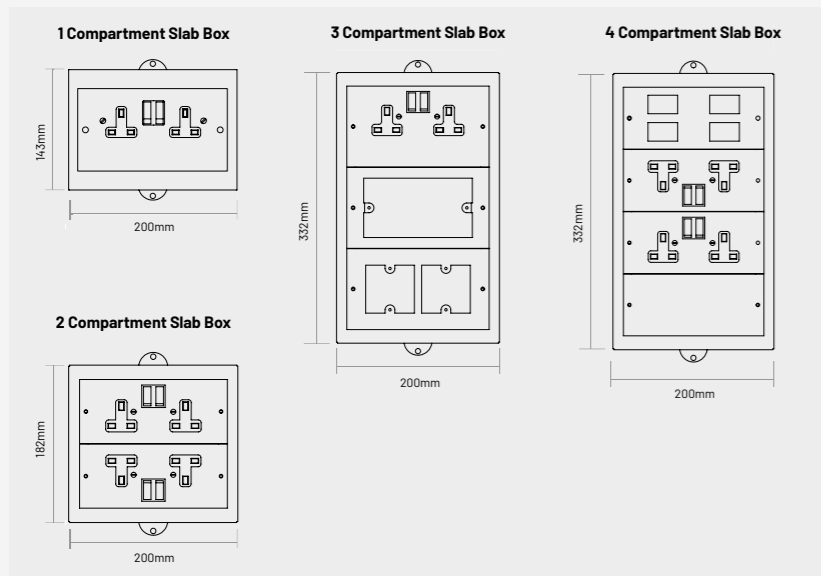

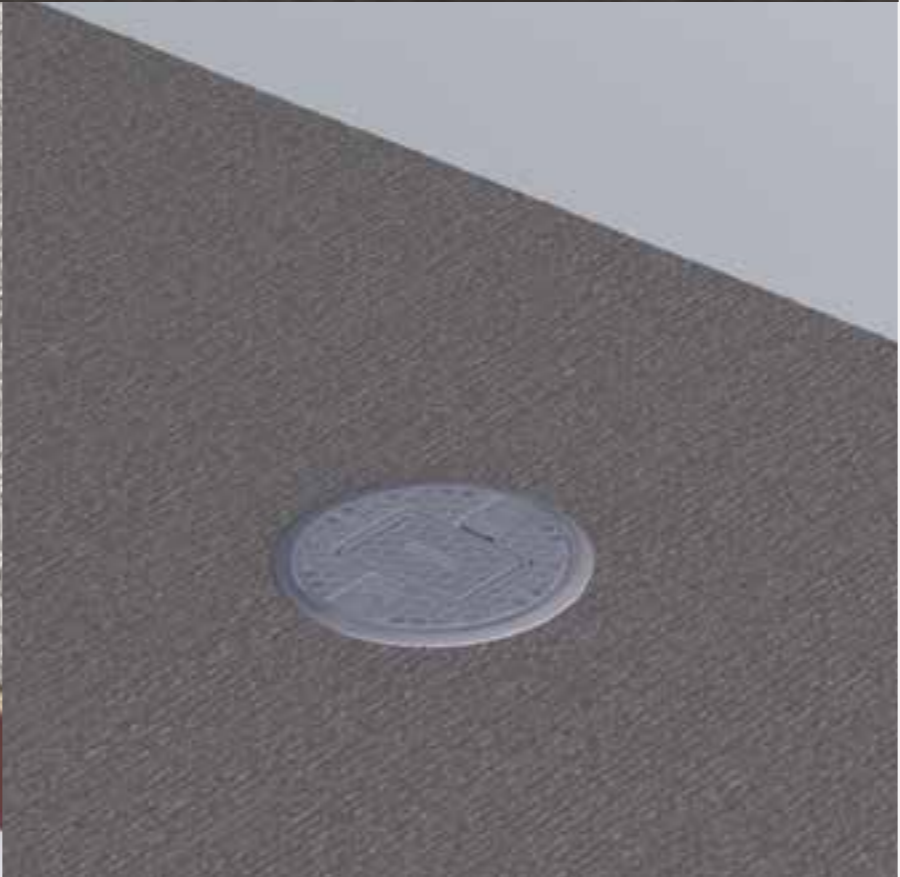
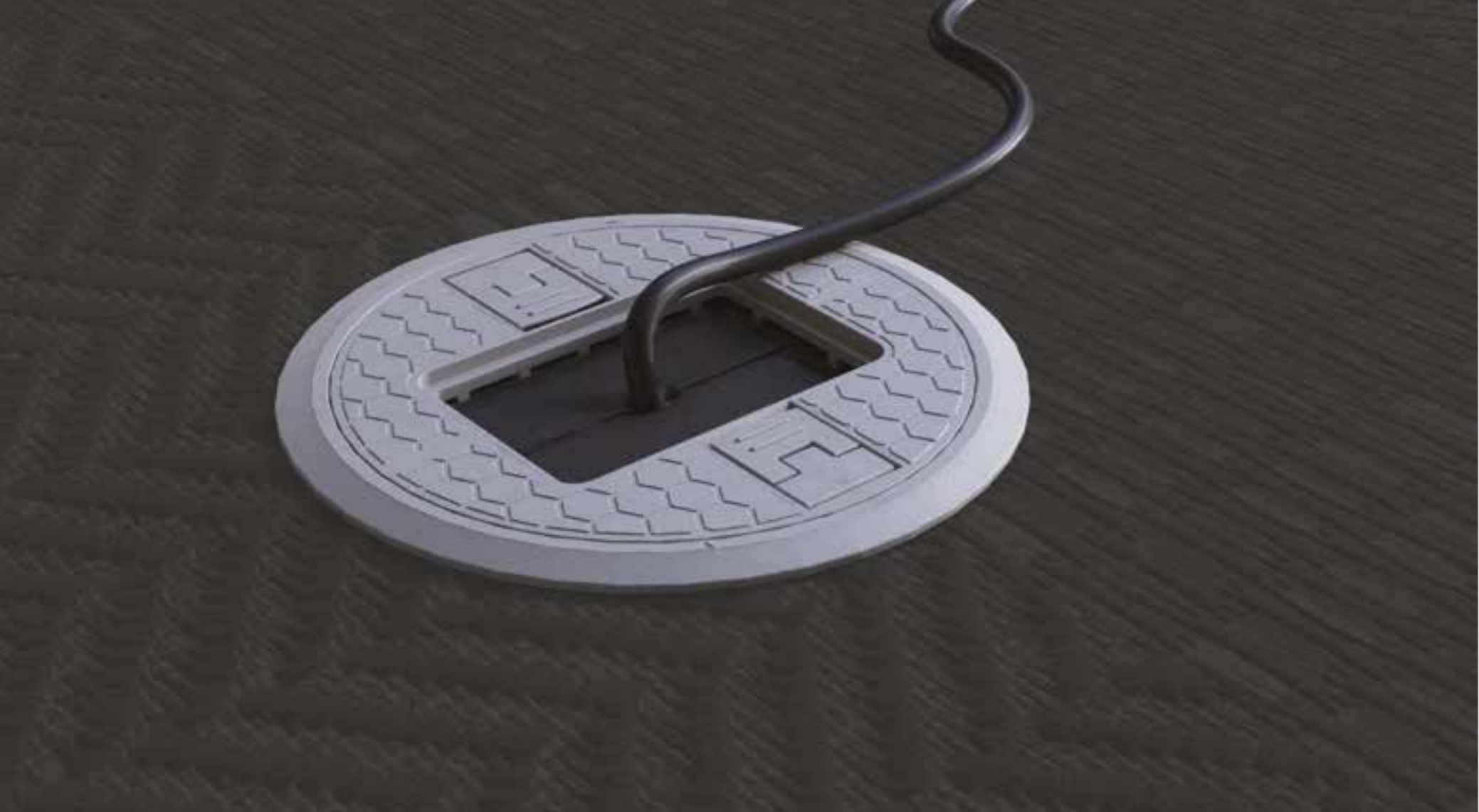

## Cable Hive

Our 26 Series Hives are designed to fit a 127mm cut-out and are suitable for raised floor applications. With a range of options available, efficient, and fast-fit on site installation, our 26 Series Hives are perfect use in offices and commercial spaces.

### OVERVIEW

- 26 Series 127mm diameter cut out (140mm overall diameter)
- 21 Series 210mm diameter cut out (230mm overall diameter)
- Multiple options available for any specification requirements
- Designed to comply with BS EN 61534-22 Powertrack systems
- Cable Hives fitted with power sockets can be pre-wired with a Betatrak tap-off for ease of installation
- Low profile Cable Hive surround to reduce the risk of tripping as per BS EN 61534-22
- Installed in seconds with no tools required
- Carpet can fit into a 6.5mm recess in versions with a tray lid

### DIMENSIONS

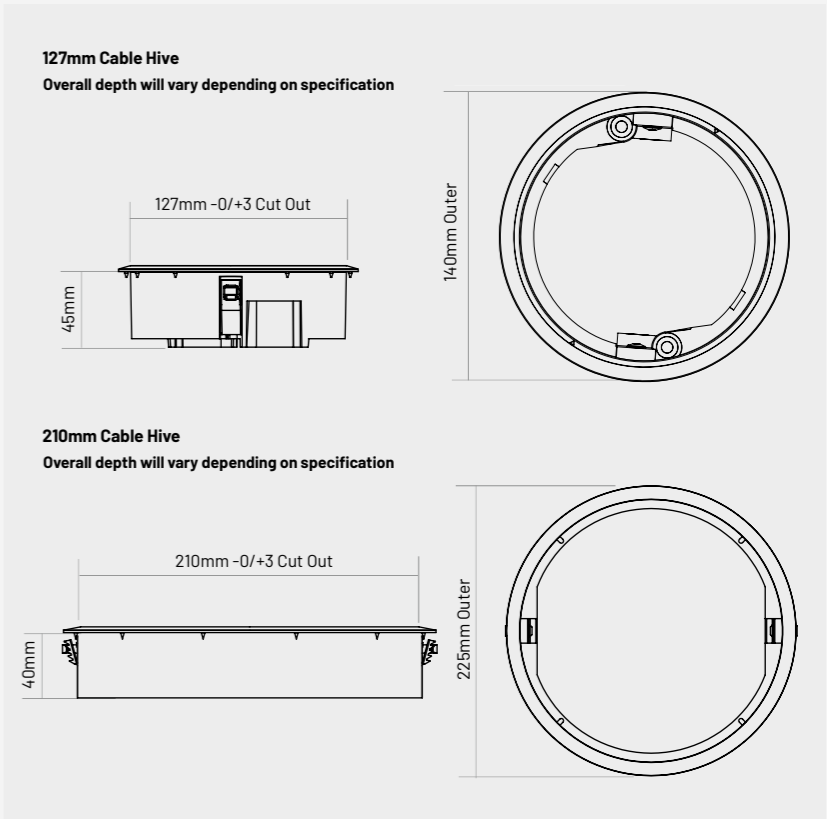

## Cable Grommet

Our 23 Series cable grommets are designed to fit a 127mm cut-out and are suitable for raised floor applications. With a range of options available, efficient, and fast-fit on site installation, our 23 Series cable grommets are perfect use in offices and commercial spaces.

### OVERVIEW

- **23 Series 127mm diameter cut out (140mm overall diameter)**
- **23 Series 210mm diameter cut out (230mm overall diameter)**
- **Multiple options available designed to meet your specification requirements**
- **Designed to comply with BS EN 61534-22 Traffic Load Tests**
- **Low profile Cable Hive surround to reduce the risk of tripping as per BS EN 61534-22 Powertrack systems. Particular requirements for powertrack systems intended for onfloor or underfloor installation, section 9**
- **Can be installed in seconds without the use of tools**

### DIMENSIONS

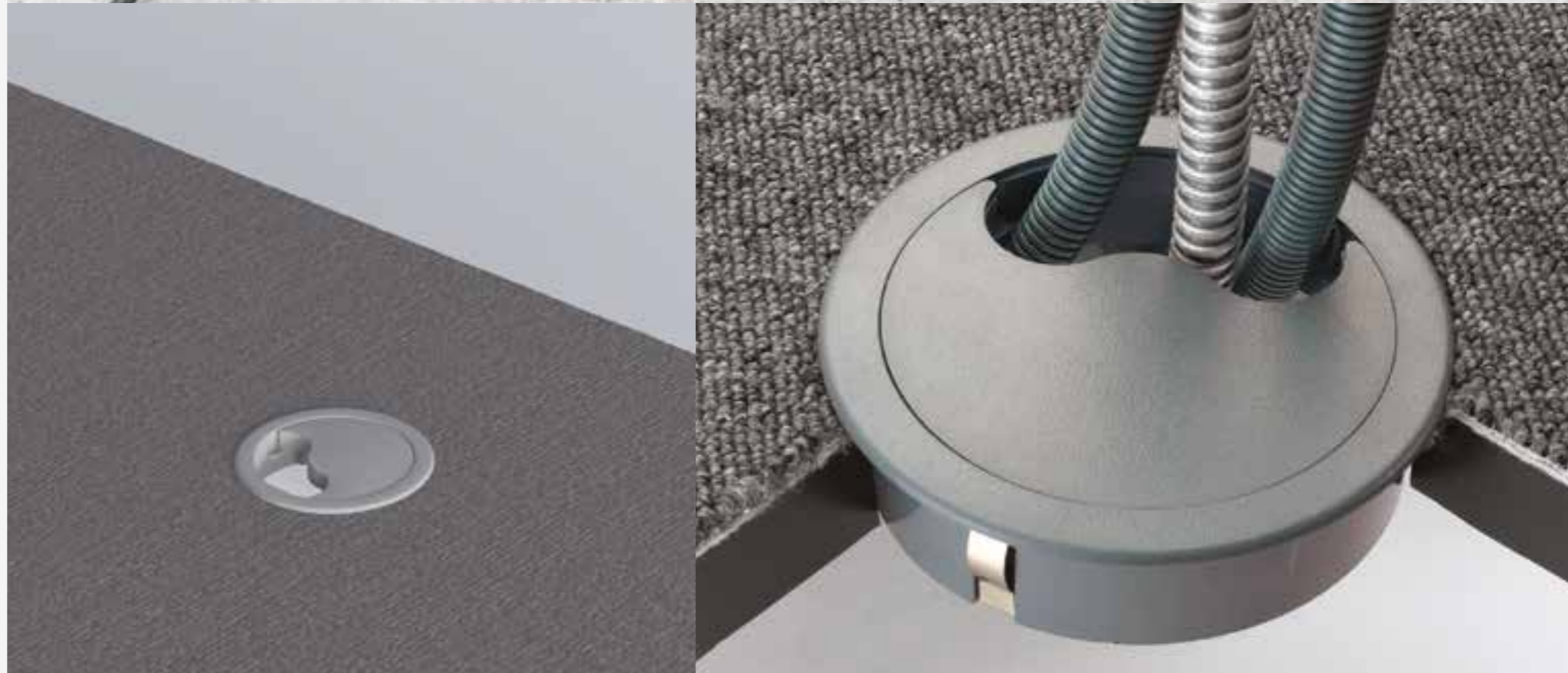
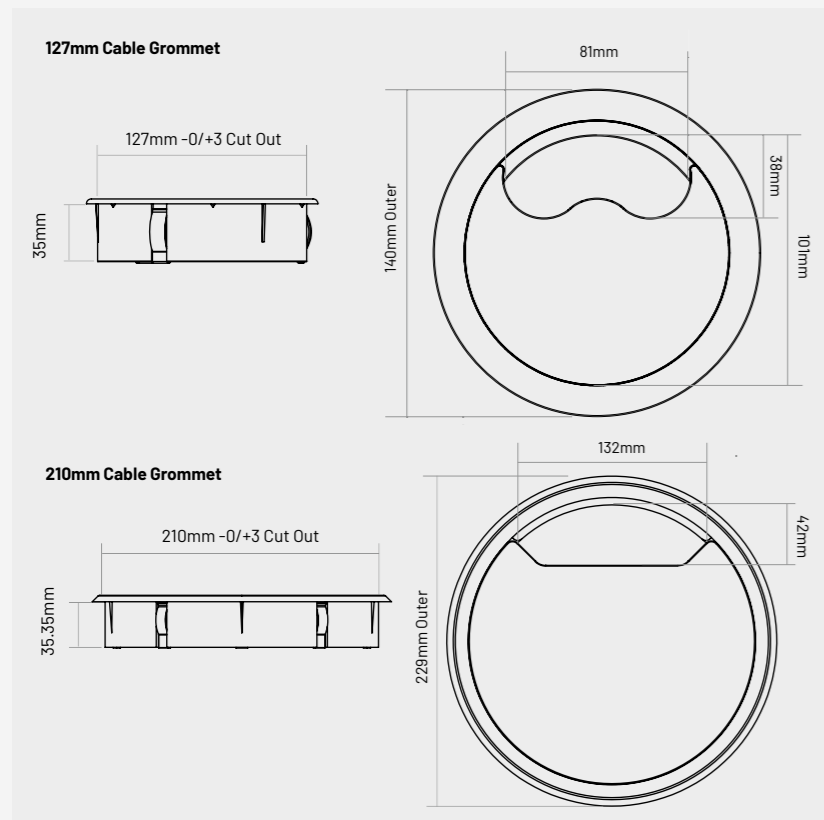

## Rotasoc®

Rotasoc is a modular and reconfigurable workstation power system that allows compliance with BS 7671 Requirements for electrical installations or BS 6396 Electrical systems in furniture - specification. Rotasoc is BSI Kitemark accredited and is tested every six months.

Rotasoc can cater for Standard and Clean Earth (C/E) low noise systems and provides complete flexibility to your workstation layout. Available in both 32A and 16A versions Rotasoc has uniquely designed socket modules with 32A internal busbars that do not require internal wiring, offering unlimited 360 degree socket rotation.

### OVERVIEW

- **A comprehensive range of interchangeable modules**
- **Ultrasonically sealed units**
- **Fast-fit modular system**
- **Socket modules allow unlimited socket rotation due to busbar**
- **Lever latching for secure connection between modules**
- **Concealed screw fixings**

### FEATURES

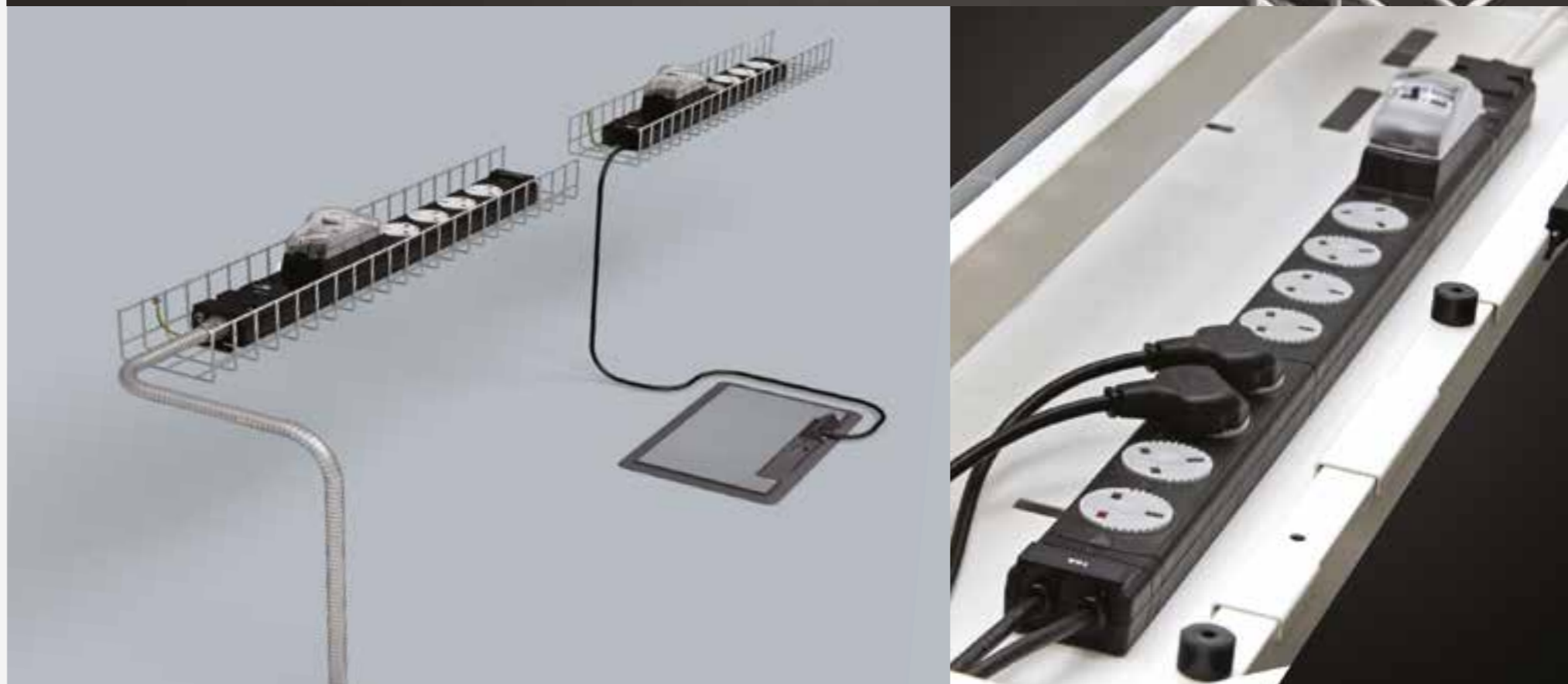
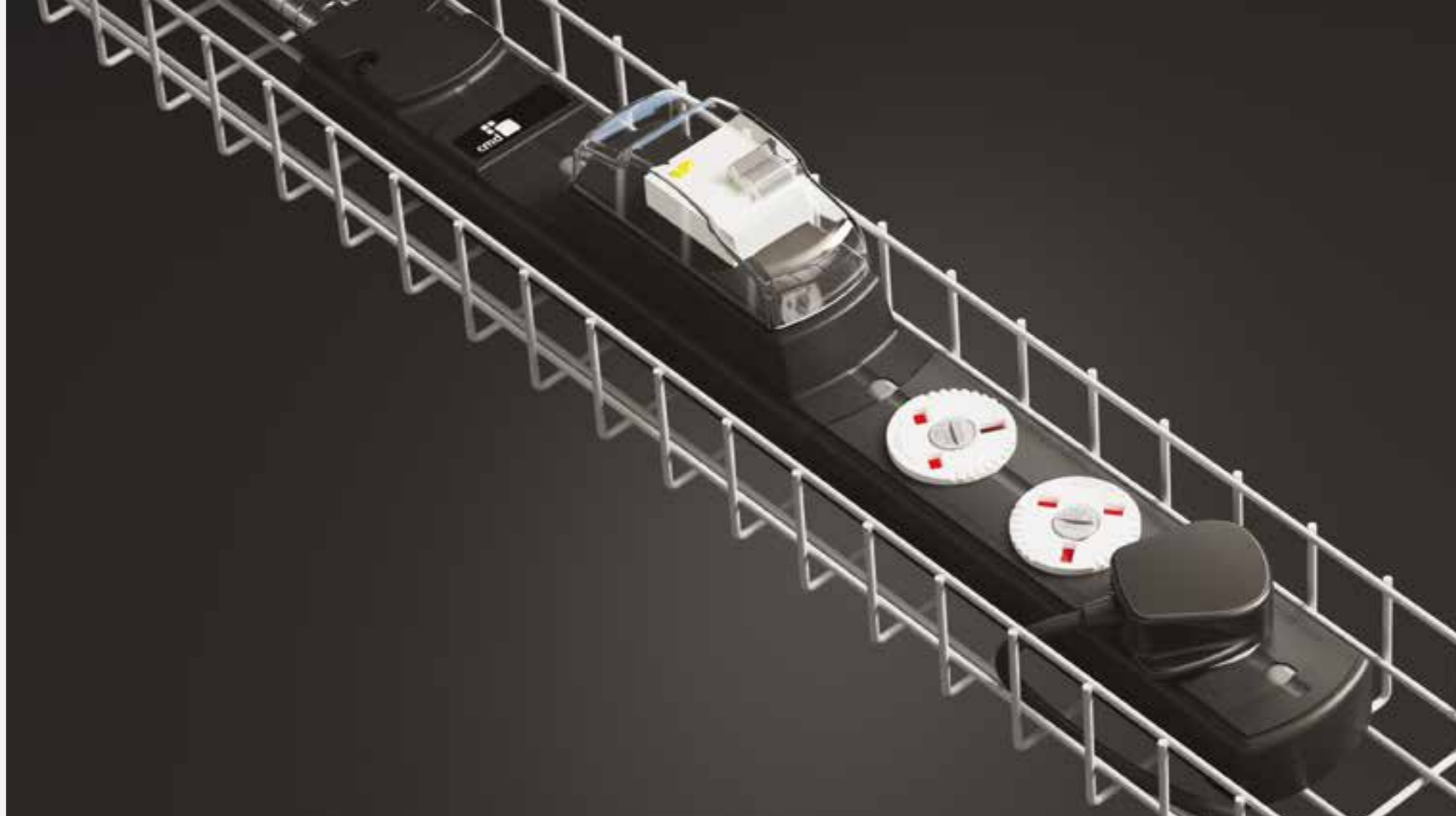

Standard Earth

Clean Earth (C/E) Low Noise



- Available as fused or unfused
- Colour coded key connections

# Rotasoc Specification Guide

**STEP 1**

Begin by choosing your Rotasoc system type.

Standard Earth



Clean Earth (C/E) Low Noise



**STEP 2**

Choose power input option:

1. Tap-off.
2. UK plug.
3. Neutrik.
4. Rewireable.



**STEP 3**

If a circuit protection device is required choose from:

1. Fuse.
2. MCB.
3. RCD.
4. RCBO.

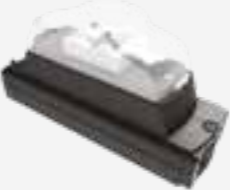

**STEP 4**

Choose a combination of the following socket modules depending on the total number of sockets required:

1. 2 Gang.
2. 3 Gang.
3. 4 Gang.



**STEP 5A**

If no further power connections are needed, add an end cap to complete your Rotasoc system.



**STEP 5B**

If a power connection to an on desk workstation module is needed, choose from our range of 16A interconnection modules.



Choose from our ranges of on desk workstation modules.

**STEP 5C**

If a power connection to an additional workstation is needed, choose from our range of 32A and 16A interconnection modules.



Return to **STEP 4** to choose sockets for the additional workstation(s).



## Rotasoc Exploded View

2, 3 and 4 socket outlet modules are available and easily interchangeable

Each socket provides 360° unlimited rotation

4.8mm<sup>2</sup> internal copper Live, Neutral and Earth busbars

Colour coded to prevent different system from being connected



---

**HEAD OFFICE**

Eastwood Trading Estate  
Rotherham  
South Yorkshire  
S65 1EN

+44 (0)1709 829511  
sales@cmd-ltd.com

---

**LONDON SHOWROOM**

3 Baltic Street East  
London  
EC1Y 0UJ

+44 (0)20 72517080  
sales@cmd-ltd.com

cmd.